

CYBOX GW-P

MOBILE WIRELESS GATEWAY WITH LTE AND WI-FI 5 / WAVE 2



CONFIGURATION MANUAL

Version: 2.0 for firmware V22.50.02 | Date: 28.11.2023

Contents

1	IMPORTANT INFORMATION	1
1.1	Disclaimer	1
1.1.1	Copyright	1
1.1.2	GPL Statement for CyBox Software	1
1.1.2.1	Disclaimer of Warranty	2
1.1.2.2	Limitation of Liability	2
1.1.3	Regulatory Limits for Changes in Country and Transmit Power Settings	2
1.2	Known Issues	2
2	ABOUT THIS DOCUMENT	3
2.1	Information about Formatting	3
3	ABOUT THE CyBox GW	3
4	HOW TO ACCESS THE CyBox GW	4
4.1	IP Addresses of the CyBox GW	4
4.2	Getting to the Web Interface	5
5	QUICK START GUIDE	6
5.1	Change Password	6
5.2	Change LAN IP address (Quick Guide)	6
5.2.1	Disabling IPv6	7
5.3	Example: Local Access Point	8
5.3.1	System Settings	8
5.3.2	Prepare WLAN Radio Interface	9
5.3.3	Connect radio0 to the Network	9
5.3.4	Connecting to WAN	10
5.4	Example: Connecting three VLANs to a server	10
5.4.1	Create the Management VLAN	11
5.4.2	Add two unmanaged VLANs	11
5.4.3	Configure and Enable the radio(s)	12
5.4.4	Attach the “Clients” VLAN to radio0	12
5.4.5	Attach the “Staff” VLAN to radio0	13
5.4.6	Check Configuration	13
5.4.7	Disable Unneeded Default Address	14
5.5	Example: Client Isolation within the Access Point	14
5.5.1	Isolate the Radio Clients	14
5.5.2	Restrict Access to Local Ports to Specified Interfaces	14
6	THE WEB INTERFACE	15
6.1	Network	15
6.1.1	Interfaces	15
6.1.1.1	DHCP Server per Interface	15

6.1.1.2	Bridges	15
6.1.1.3	VLAN	17
6.1.1.4	LTE	18
6.1.1.4.1	Configuring LTE	18
6.1.1.4.2	LTE Troubleshooting	20
6.1.1.4.3	Modem Status Information	21
6.1.1.4.4	5G	22
6.1.2	WLAN	23
6.1.2.1	Channel, Wireless mode, HT mode, Power settings	23
6.1.2.2	JJPlus Radio Card Band Configuration	24
6.1.2.3	ESSID, WDS Mode, Client separation	25
6.1.2.4	Encryption	25
6.1.2.5	Hotspot 2.0	27
6.1.2.6	Multi-AP Client Isolation	27
6.1.2.7	Connection Check	28
6.1.2.8	Access Point Scanning Service (Wireless Monitoring)	29
6.1.2.9	Client Counting Service	31
6.1.2.10	Rogue Access Point Detection Service	33
6.1.3	Multi-WAN Manager (MWAN3)	34
6.1.3.1	Capabilities	36
6.1.3.2	MWAN Test	36
6.1.3.2.1	Gateway	36
6.1.3.3	MWAN Status	37
6.1.3.4	MWAN Modem Interface Configuration	39
6.1.3.5	MWAN Members Configuration	40
6.1.3.6	MWAN Policies Configuration	41
6.1.3.7	MWAN Rules Configuration	42
6.1.3.8	MWAN Notification Configuration	42
6.1.4	LACP / Bonding	43
6.1.4.1	LACP configuration example	43
6.1.4.1.1	Create LACP interface	44
6.1.4.1.2	Setup IP / Netmask	44
6.1.4.1.3	Setup bonding Policy / add slave Interfaces	44
6.1.4.1.4	Setup Firewall	45
6.1.4.1.5	Check interface Status	46
6.1.4.2	LACP testing example	47
6.1.4.2.1	Test Setup	47
6.1.4.2.2	Test bonding bandwidth improvement	48
6.1.4.2.3	Test bonding reliability improvement	48
6.1.5	Global DHCP and DNS Settings	48

6.1.6	Firewall	49
6.1.7	OpenVPN	50
6.1.7.1	Configuration file generation on Windows	50
6.1.7.2	VPN interface setup – 3 methods	50
6.1.7.2.1	Copy Ready-to-use configuration with SCP	51
6.1.7.2.2	Upload configuration, certs, key-files with web interface	51
6.1.7.2.3	Manual configuration with web interface	52
6.1.7.3	VPN host configuration (on console)	52
6.1.8	QoS	54
6.2	Modem	55
6.2.1	Modem Configuration	55
6.2.2	Modem Monitor	56
6.2.2.1	Connection Information	56
6.2.2.2	Modem Information	58
6.2.2.3	Signal Information	58
6.2.2.4	QMI Command Information	59
6.3	System	59
6.3.1	System Properties	59
6.3.2	Configuration Backups	60
6.3.3	Firmware Upgrade	60
6.3.4	Reboot	61
6.3.5	Reset Button	61
6.3.6	Emergency Mode	61
7	SNMP	63
7.1	SNMP Protocol Support	63
7.2	SNMP V3 Protocol Support	63
7.2.1	SNMP V3 Protocol Examples	64
7.3	SNMP Basic Functions	65
7.4	SNMP Read and Write Authorizations	65
7.5	SNMP Commands	66
7.6	SNMP Read (snmpwalk and snmpget)	67
7.6.1	Reading System Information	67
7.6.2	Reading SNMP Object Information	67
7.6.2.1	Readout current Network Device Order	68
7.6.2.2	Readout SSID / WIFI Interface Order	68
7.6.2.3	Readout Network Device to SSID Assignment	69
7.7	SNMP Write (snmpset)	70
7.7.1	Direct command	70
7.7.1.1	Reboot	70
7.7.2	Edit configuration using Object Identifier (OID)	70

7.7.2.1	Set a new IP address	70
7.7.2.2	Set a new SSID	71
7.7.2.3	Set a new Macfilter	71
7.7.3	Edit configuration parameters, create new fields and delete items	72
7.7.3.1	Set new Hostname	72
7.7.3.2	Creating a system configuration description text	72
7.7.3.3	Delete system configuration description text	73
7.8	SNMP Applications	74
7.8.1	SNMP Support for GPS	74
7.8.2	SNMP Support for Second GPS Source	75
7.9	GPS	77
7.9.1	GPS activation	77
7.9.2	GPS status	77
7.9.3	SNMP for GPS	79
7.9.4	SNMP Support for LTE	80
7.9.4.1	LTE SNMP Read Control	80
7.9.4.2	LTE SNMP Write Control	82
8	THE FLYING CONTROLLER MECHANISM	82
9	IPSecVPN / StrongSwan	83
9.1	IPSec Customized Configuration	83
9.2	IPSec Firewall Custom Rules	83
10	SSH / SERIAL CONSOLE	85
10.1	UCI Configuration	86
10.1.1	UCI configuration files	86
10.1.2	UCI Example	86
10.2	Other commands	86
11	Serial Module SMX-200	88
11.1	Connectors on front panel	88
11.2	Serial Driver	88
11.3	Port Configuration Tool	88
11.4	Using the SMX-200 UARTs	88
12	SYSTEM MAINTENANCE	89
12.1	Remote Firmware Upgrade	89
12.1.1	Remote Firmware Upgrade without Config Change	89
12.1.2	Remote Firmware Upgrade with New Config	89
12.2	USB Possibilities	91
12.3	Status LED Blink Codes	92
13	APPENDIX: GPL LICENSE	93
14	APPENDIX: SNMP OID OVERVIEW	103
15	APPENDIX: DEFAULT FACTORY SETTINGS	105

1 IMPORTANT INFORMATION

1.1 Disclaimer

1.1.1 Copyright

© 2018-2023 Westermo Eltec GmbH. The information, data, and figures in this document including respective references have been verified and found to be legitimate. In particular in the event of error they may, therefore, be changed at any time without prior notice. The complete risk inherent in the utilization of this document or in the results of its utilization shall be with the user; to this end, Westermo Eltec GmbH shall not accept any liability. Regardless of the applicability of respective copyrights, no portion of this document shall be copied, forwarded or stored in a data reception system or entered into such systems without the express prior written consent of Westermo Eltec GmbH, regardless of how such acts are performed and what system is used (electronic, mechanic, photocopying, recording, etc.). All product and company names are registered trademarks of the respective companies.

Our General Business, Delivery, Offer, and Payment Terms and Conditions shall otherwise apply.

1.1.2 GPL Statement for CyBox Software

This software product contains software covered by the GNU GPL (see below in this document), it may in addition contain other parts covered by other licenses (such as LGPL). A list of all modules and their licenses ("FOSS" list) is available on request (see link below). The source code of all GPL-covered modules can also be requested by owners of the CyBox GW-W/LTE (see link below).

For the GPL-covered parts this license is valid:

```
Copyright (c) 2014-2023, Westermo Eltec GmbH
```

```
This program is free software: you can redistribute it and/or modify  
it under the terms of the GNU General Public License as published by  
the Free Software Foundation, either version 3 of the License, or  
(at your option) any later version.
```

```
This program is distributed in the hope that it will be useful, but  
WITHOUT ANY WARRANTY; without even the implied warranty of  
MERCHANTABILITY or FITNESS FOR A PARTICULAR PURPOSE. See the  
GNU General Public License for more details.
```

```
You should have received a copy of the GNU General Public License  
along with this program. If not, see  
<https://www.gnu.org/licenses/>.
```

FOSS and sources are not included in the binary distribution in the products and in the product documentation due to space limitations.

Use this link to request FOSS and sources, please send in your request by mail (handling fees for sources may apply):

Westermo Eltec GmbH

Galileo-Galilei-Str. 11

55129 Mainz

Germany

<https://www.eltec.com>

support.eltec@westermo.com

1.1.2.1 Disclaimer of Warranty

There is no warranty for the program, to the extent permitted by applicable law. except when otherwise stated in writing the copyright holders and/or other parties provide the program “as is” without warranty of any kind, either expressed or implied, including, but not limited to, the implied warranties of merchantability and fitness for a particular purpose. The entire risk as to the quality and performance of the program is with you. Should the program prove defective, you assume the cost of all necessary servicing, repair or correction.

1.1.2.2 Limitation of Liability

In no event unless required by applicable law or agreed to in writing will any copyright holder, or any other party who modifies and/or conveys the program as permitted above, be liable to you for damages, including any general, special, incidental or consequential damages arising out of the use or inability to use the program (including but not limited to loss of data or data being rendered inaccurate or losses sustained by you or third parties or a failure of the program to operate with any other programs), even if such holder or other party has been advised of the possibility of such damages.

You should have received the following text in an “About” box (see also Web Interface [Status](#) → [Advanced](#)) together with the product. Here it is replicated for reference:

```
This software product contains software covered by the GNU GPL license.
A list of all modules and their licenses ("FOSS" list) is available on
request, as is the source code of all GPL-covered modules. For details
and GPL text, see the Software Configuration Manual, available on
<https://www.eltec.com>. In case of problems use the
mail (street) address below.
```

```
Request FOSS and sources with a mail to:
```

```
Westermo Eltec GmbH
Galileo-Galilei-Str. 11
55129 Mainz
```

```
Germany
```

1.1.3 Regulatory Limits for Changes in Country and Transmit Power Settings

Make sure that only persons with proper knowledge also in regulatory matters have access to the access point's configuration settings. They must be aware of the consequences of an improper setting of country and transmit power (there may be additional settings). To do so, the standard configuration password must be changed before the access point is deployed. This new password must be given to knowledgeable and responsible persons only.

One example of a regulation affecting country selection is that in Germany, as of October 2016, the frequencies in the range 5150 MHz - 5350 MHz must be used in closed rooms and similar environments only. For more information please see www.bundesnetzagentur.de.

1.2 Known Issues

- When operating WLAN in 11ac mode, the transmit data rate is erroneously wrongly reported as 6 Mbit/s.

2 ABOUT THIS DOCUMENT

This configuration manual is intended for system developers and integrators. It is not intended for end users. It describes the firmware functions of the access point/router/gateway product family and provides information for special applications and configurations of the product.

This manual is intended to guide through the configuration process of an Access Point/Router/Gateway (the names of which are used interchangeably for this manual) for use in a train or bus. We tried to cover the main aspects of this task, including

- Backup and restore of configurations
- Install new firmware versions
- Handling of IP addresses, DHCP, VLAN, VPN, firewall
- Configuration of WiFi and LTE
- MWAN configuration for multiple WAN connection
- Westermo Eltec's train coupling, wireless backbone protocol ICCP
- Remote administration via SNMP
- Scripting and UCI.

Not covered is a complete list of all functions and of all configuration elements in detail.

Information about mechanical and electrical installation of the access points is available in a separate product-specific installation manual which can be downloaded from the Download Center at www.eltec.com.

2.1 Information about Formatting

In the following sections, text formatted like `this` refers to titles, tabs, boxes, menu names, group names, keys, and other descriptive text on the web-based configuration user-interface ("LuCI"). They are grouped by "→".

This markup is used for all navigation elements needed to access settings, independent from the elements used to click on them or just for visual grouping.

A `typewriter` font is used for text typed in.

The internal version of this document is 436a4b5.

3 ABOUT THE CyBox GW

The CyBox GW is a member of the CyBox family of robust wireless communication gateways. It is particularly designed to meet the requirements of rolling stock applications. It offers stable, secure, and broadband LTE connections for train-to-ground connections and high-speed internet. It serves as a WAN gateway and as an access point.

The CyBox GW is a new member of Westermo Eltec's LTE router concept, expanding the CyBox AP and CyBox AP 2 access points. The hardware features five miniPCI Express slots to support up to five WLAN cards or up to four LTE modules or a mixed configuration.

It comprises a new family due to its vastly enhanced performance.

The CyBox GW firmware provides a convenient management interface via a web service. Besides global setup parameters the open source software allows the configuration of the radio interfaces, such as channel selection, SSID, encryption keys, and firewall setup. The access point and router configurations as well as the management firmware can be updated remotely.

The firmware of the device is based upon Linux and OpenWRT. For Open Source information see the preface.

4 HOW TO ACCESS THE CyBox GW

The CyBox GW can be configured in several ways:

1. The graphical web interface
2. The command line interface via a SSH or serial connection, see [10 SSH / SERIAL CONSOLE](#)
3. Using an USB stick (to update the firmware or apply a prepared configuration, see [12.2 USB Possibilities](#))
4. Using SNMP (see [7 SNMP](#))

4.1 IP Addresses of the CyBox GW

By default, the CyBox GW is accessible through the following IP addresses (see figure The page Network → Interfaces (default settings)):

- [192.168.100.1](#) (LAN)
- An address obtained using DHCP (if possible LAN_DHCP)
- An address derived from the serial number (LAN_ALIAS)
- An address derived from the MAC of the first Ethernet port (LAN_MAC)

The LAN_ALIAS address is derived from the serial number (which is printed on the type plate) as follows (Example Serial Number: EL303289):

1. Strip non-digits: 303289
2. Print as six-digit hex value: 0x04A0B9
3. Use the upper 8 bits for x, the middle for y and the lower for z: x=0x04 y=0xA0 z=0xB9
4. Convert x,y,z to decimal: x=4 y=160 z=185
5. The LAN_ALIAS address is 10.4.160.185

In a similar manner, the LAN_MAC address is derived from the MAC address of the first Ethernet interface, which is printed on the type plate (example MAC 00:00:5B:04:AE:03):

1. Take the last three bytes: 04:AE:03
2. Use the upper 8 bits for x, the middle for y and the lower for z: x=0x04 y=0xAE z=0x03
3. Convert x,y,z to decimal: x=4 y=174 z=3
4. The LAN_MAC address is 10.4.174.4

You can delete unneeded network interfaces by clicking on the red “Delete” button in the web interface.

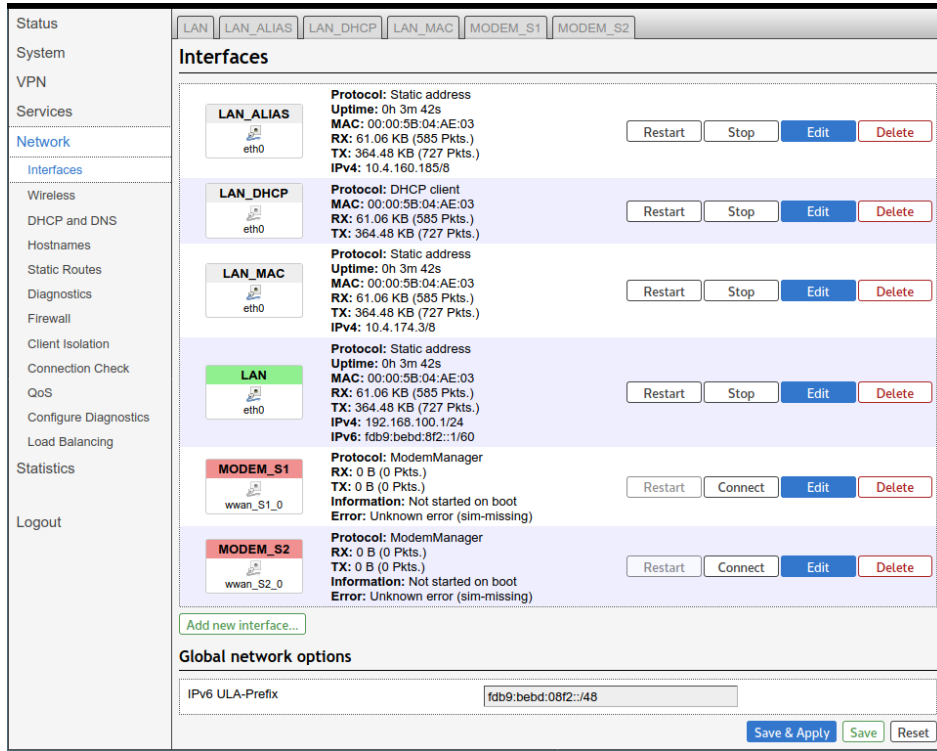

The page Network → Interfaces (default settings)

4.2 Getting to the Web Interface

Before accessing the web interface, your computer must be connected to the Ethernet port LAN 1, and it must be configured to use the same subnet as the CyBox GW.

The web interface is accessible using HTTPS on the IP addresses listed in 4.1 IP Addresses of the CyBox GW (default: <https://192.168.100.1/> in the subnet 192.168.100.0/24). It uses a self-signed SSL certificate. Your browser should warn you about that. You can either accept the certificate or fall back to HTTP: <http://192.168.100.1/>.

On the login web page, use username `root` and password `root`. Of course, you should 5.1 Change Password as soon as possible.

Once connected, you can navigate through the different tabs to start configuration. A few rules apply:

- To apply and also save your configuration, click on the button `Save & Apply` on the bottom-right corner of most pages. Not clicking on this button will discard your modifications.
- Saved configurations will be kept after a reboot.
- If IP addresses are changed, the Access Point must be addressed under the new URL in the browser.

5 QUICK START GUIDE

This chapter describes the steps to configure standard access point operation. The device must be electrically connected (see installation manual). Factory default settings are used.

This chapter shows some common use-cases and an exemplary implementation for each.

When the CyBox GW configuration requires deep changes, e.g. for a new use-case, there is some risk that previous (maybe meanwhile forgotten) settings get into conflict with the new configuration. Thus it is recommended to start the configuration from factory default settings. Pressing the hardware reset switch for more than 5 seconds will restore the factory settings.

The web interface provides the same function: `System` → `Backup / Flash Firmware` → `Perform reset`.

For all below configuration examples, the following initial situation is assumed:

- CyBox GW is running
- CyBox GW has been reset to factory defaults, the IP address is 192.168.100.1
- Default Root-User password: 'root'
- Operator workstation and CyBox GW are connected via Ethernet
- Workstation browser is logged-in to the CyBox GW web interface
- Operator is additionally logged in to CyBox GW via SSH (if available, a serial console terminal would be preferable).

In the following examples [square brackets] are used to indicate actions not requiring operator interaction because they happen automatically or have already been done (mentioning them here might be useful for checking configuration is on the right way).

5.1 Change Password

The password should be changed first to avoid legal consequences as described in the preface. The default user/password is 'root'/'root'. To change it, go to `System` → `Administration`, type new password and click `Save`.

<ul style="list-style-type: none"> Status System System Administration Startup Scheduled Tasks Mount Points Backup / Flash Firmware Custom Commands 	<div style="border: 1px solid #ccc; padding: 5px;"> <div style="display: flex; border-bottom: 1px solid #ccc;"> <div style="border-right: 1px solid #ccc; padding: 2px 5px;">Router Password</div> <div style="padding: 2px 5px;">SSH Access</div> <div style="padding: 2px 5px;">SSH-Keys</div> </div> <h3 style="margin-top: 5px;">Router Password</h3> <p style="font-size: small; margin-top: 5px;">Changes the administrator password for accessing the device</p> <div style="margin-top: 10px;"> <div style="display: flex; justify-content: space-between; align-items: flex-start;"> <div style="width: 80%;"> <p style="font-size: small; margin-bottom: 5px;">Password</p> <input style="width: 95%; border: 1px solid #ccc;" type="password" value="....."/> </div> <div style="width: 10%; text-align: center; font-size: small;">*</div> </div> <div style="margin-top: 10px;"> <div style="display: flex; justify-content: space-between; align-items: flex-start;"> <div style="width: 80%;"> <p style="font-size: small; margin-bottom: 5px;">Confirmation</p> <input style="width: 95%; border: 1px solid #ccc;" type="password" value="....."/> </div> <div style="width: 10%; text-align: center; font-size: small;">*</div> </div> <div style="margin-top: 5px; font-size: x-small;"> ? Password strength: </div> </div> <div style="text-align: right; margin-top: 10px;"> <input style="border: 1px solid #007bff; color: #007bff;" type="button" value="Save"/> </div> </div></div>
--	--

Change Password

5.2 Change LAN IP address (Quick Guide)

The factory default IP address `192.168.100.1` must be changed to meet your network topology. Open `Network` → `Interfaces` and click the `Edit` button of the LAN interface. Modify the IP address (IPv4 address field), or change the `Protocol` field to `DHCP client`, then click on `Save && Apply`. To regain access to the web interface, you must type the new IP address in your browser.

Interfaces » LAN

General Settings | Advanced Settings | Physical Settings | Firewall Settings | DHCP Server

Status

Device: eth0
 Uptime: 1h 27m 45s
 MAC: 00:00:5B:03:B5:79
 RX: 1.49 MB (8494 Pkts.)
 TX: 2.14 MB (3808 Pkts.)
 IPv4: 192.168.100.1/24
 IPv6: fd96:db0e:c0f1::1/60

Protocol: Static address

Bring up on boot:

IPv4 address: 192.168.100.1

IPv4 netmask: 255.255.255.0

IPv4 gateway:

IPv4 broadcast: 192.168.100.255

Use custom DNS servers: +

IPv6 assignment length: 60
Assign a part of given length of every public IPv6-prefix to this interface

IPv6 assignment hint: 0
Assign prefix parts using this hexadecimal subprefix ID for this interface.

IPv6 suffix: ::1
Optional. Allowed values: 'eui64', 'random', fixed value like '::1' or '::1:2'. When IPv6 prefix (like 'a:b:c:d::') is received from a delegating server, use the suffix (like '::1') to form the IPv6 address ('a:b:c:d::1') for the interface.

Dismiss Save

LAN Configuration Example

5.2.1 Disabling IPv6

The custom helper script under `System` → `Custom Commands` → `Dashboard` will modify the network / firewall configuration to disable all IPv6 network traffic. Normally all network interfaces have an automatic IPv6 address applied. If your environment has no need for IPv6 network traffic, you should use this script in early configuration steps, to remove every IPv6 address setup form network interfaces and to remove IPv6 firewall rules. Note that the Run button has to be executed twice. The first time is only for user information. The configuration modification is permanent.

The screenshot shows the 'Custom Commands' section of the web interface. It contains a grid of command cards. The 'System IPv6 Disable' card is selected, displaying the following information:

- System Information**: Command: `cyap_status`
- System IPv6 Disable**: Command: `disable_ipv6_support`
- Wireless Info**: Command: `wireless_info`
- ICCP Config**: Command: `cfg_iccp`, Arguments:
- Modem Information**: Command: `modem_info`, Arguments:
- Modem Manager Debug**: Command: `modemmanager_debug`, Arguments:
- Modem Gateway**: Command: `modem_gateway`, Arguments:
- Modem Speedtest**: Command: `modem_speedtest`, Arguments:
- Modem Factory Reset**: Command: `modem_factory_reset`, Arguments:

Below the command cards, the content for the selected command is shown:

```
# "disable_ipv6_support"
This script will remove IPv6 support from the current configuration.
This script only needs to run once. New settings are saved to 'network'
and 'dhcp'. Firewall rules with family=ipv6 are removed from configuration.
As finished the firewall IPv6 traffic counters should be zero.

This is the first call without action - Run again to apply new settings.
```

A yellow error message at the bottom states: **Command failed (Code: 256)**

Disable network IPv6 support – first run

5.3 Example: Local Access Point

As a first step, a simple access point is configured. The wired Ethernet and the wireless radios form an isolated local domain where the CyBox GW provides DHCP services. Finally the example in „LAN IP Address“ shows how to set a new static IP address. In Network > Interfaces → LAN → Protocol you can configure the DHCP client setup to obtain an IP address from a DHCP server in your network. The access point and its clients become part of another local domain where DHCP, DNS, and a gateway are provided, connecting the CyBox GW and its clients to higher-level networks.

5.3.1 System Settings

- Select **System** → **System** (yes, two *System* tabs nested).
- In box **System Properties** select tab **General Settings**: adjust the entries as needed; button **Sync with browser** is useful for cases where no NTP server is available. Tabs **Logging** and **Language and Style** may be ignored for now.
- In the tab **Time Synchronization**: adjust the entries if needed.
- Click button **Save && Apply**

5.3.2 Prepare WLAN Radio Interface

- Select **Network** → **Wireless**: this shows the wireless controllers *radio0* and *radio1* with some software buttons
- Select tab **radio0: Unknown "OpenWrt"** or click the **Edit** button of **radio0**
- In box *Device Configuration*:
 - Select tab *Advanced Settings*
 - In drop-down menu *Country Code*, select the country of the current location
 - Select tab *General Setup*
 - In drop-down menu *Mode*, select a mode, usually *N* or *AC*
 - In drop-down menu *Channel*, select a channel (or *auto*)
 - If needed, select an appropriate value in drop-down menu *Transmit Power*
- In box *Interface Configuration*:
 - [Select tab *General Setup*]
 - Enter an arbitrary *ESSID* (will be quoted below as "WLssid")
 - [Mode: select *Access Point*]
 - [Field *Network*: activate checkbox *lan*]
 - [Field *Network*: clear checkbox *create*]
 - If needed, activate checkbox *Hide ESSID*
 - Select tab *Wireless Security*
 - In drop-down menu *Encryption*, select as needed
 - In drop-down menu *Cipher*, select *auto* unless a specific algorithm is required
 - Enter encryption *Key* at least 8 characters
- Click button *Save & Apply*
- Select **Network** → **Wireless**
 - For *radio0*, click button *Enable*

At this point, the radio interface should become visible to possible WLAN clients and vice versa. Probably clients need to be prompted to scan for available wireless networks. Then, those clients will become visible in tab *Network*, tab *WiFi*, box *Associated Stations*.

5.3.3 Connect radio0 to the Network

- Select tab *Network* tab *Interfaces* tab *LAN*
- In box *Common Configuration*
 - Select tab *Physical Settings*:
 - *Bridge interfaces*: activate checkbox
 - [Enable STP: clear checkbox *Spanning Tree Protocol on this bridge*]
 - [Interface : activate checkbox *Ethernet Adapter: "eth0"*]

- *Interface* : activate checkbox *Wireless Network: Master* “<SSID>”
- [*Interface* : clear checkbox *Custom Interface*]
- In box *DHCP Server*
 - Select tab *General Setup*
 - Clear checkbox *Disable DHCP for this interface*
 - If needed, modify more things in tab *General Setup* and tab *Advanced Settings*
 - Click button *Save & Apply*

Now the CyBox GW connects the Ethernet and all WLAN clients in the local domain 192.186.100.0 and provides a local DHCP service, but there is not yet an uplink to a gateway.

5.3.4 Connecting to WAN

As a goal, the CyBox GW shall integrate its clients via Ethernet in a higher-level network. DHCP, DNS, and gateway services are supposed to be available in that net.

- Select tab *Network* tab *Interfaces* tab *LAN*
- In section *Common Configuration*:
 - In drop-down menu *Protocol*, select *DHCP Client*
 - Click button *Switch Protocol*
- Click button *Save & Apply*

This terminates the local domain 192.186.100.0. Now connect the CyBox GW via Ethernet to the gateway domain, restart the CyBox GW (use hardware reset switch) and reconnect the WLAN clients.

5.4 Example: Connecting three VLANs to a server

In this use-case the access point provides 3 VLAN interfaces:

- one for management access via wired Ethernet, using a static IP address
- an unmanaged WLAN access for “clients”, no encryption
- another unmanaged WLAN access for “staff” members, encrypted, optional hidden SSID

The access point is connected via Ethernet to a server (or a host computer, called CCU in the illustration below) providing DHCP, DNS, and gateway services. Starting from factory defaults, apply system settings as described in section 7.2.1 (if needed).

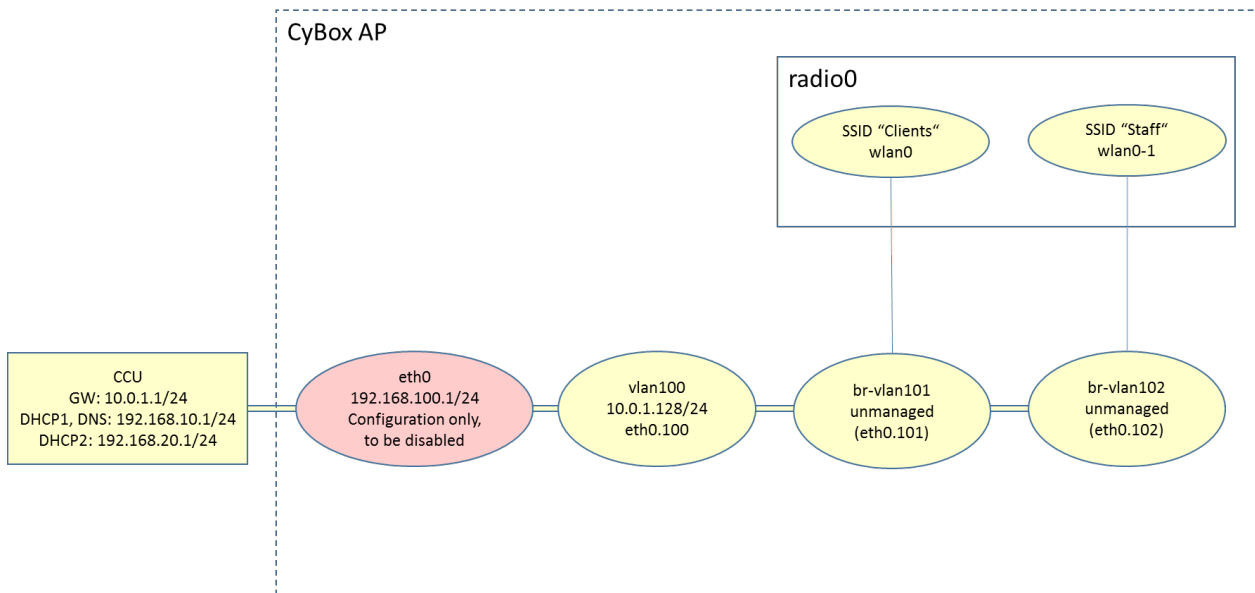

Network Topology with Three VLANs

5.4.1 Create the Management VLAN

Create a new Ethernet interface (eth0.100) and give it the name “vlan100”. Make it a full-valued net host by assigning a static address and a gateway.

- Select tab *Network* tab *Interfaces*
- Click button *Add new interface*
- Enter *Name of new interface*: “vlan100”
- [Select *Protocol of the new interface*: Static address]
- [Clear checkbox “*Create a bridge over multiple interfaces*”]
- Enter name of *Custom Interface*: “eth0.100”
- Click button *Submit*
- [page VLAN100 opens]
- [Tab *Network* tab *Interfaces* tab *VLAN100* tab *General Setup*]
 - Enter *IPv4 address* “10.0.1.128”
 - Select *IPv4 netmask* 255.255.255.0
 - Enter *IPv4 gateway* “10.0.1.1”
- Click button *Save & Apply*

5.4.2 Add two unmanaged VLANs

We create 2 more Ethernet interfaces eth0.101 and eth0.102 with names vlan101 and vlan102, resp.

- Network Interfaces: Add new interface → Name of new interface: “vlan101”
- Protocol of new interface: Unmanaged
- [Clear Create a bridge over multiple interfaces]
- Custom Interface: “eth0.101 “

- Submit
- [page VLAN101 opens]
- Click button *Save & Apply*

Do the same for “vlan102” and “eth0.102”.

5.4.3 Configure and Enable the radio(s)

You are free which interface to assign to which radio. If both radios are to be used then this section (7.3.3) must be done for *radio1* as well.

- Select tab *Network* → tab *WiFi* → tab *radio0* (or click button *Edit* for *radio0*)
- In box *Device Configuration*:
 - Select tab *Advanced Settings*
 - Select Country Code
 - Select Mode

The following 3 lines fix a problem with this LuCI page (The drop-down menu for the country code is not updated correctly)

- Click button *Save & Apply*
- Logout / Login
- Select tab *Network* → tab *WiFi* → tab *radio0* (or click button *Edit* for *radio0*)

Now we can complete the configuration for *radio0*:

- In box *Device Configuration*:
 - Select tab *Advanced Settings*
 - Select *HT mode*
 - Select *Channel*
 - Select *Transmit Power*
- Click button *Save & Apply*
- Select tab *Network* → tab *WiFi*
- Click button *Enable* for *radio0*

5.4.4 Attach the “Clients” VLAN to radio0

- Select tab *Network* → tab *WiFi* → tab *radio0* (or click button *Edit* for *radio0*)
- In box *Interface Configuration*:
 - [Select tab *General Setup*]
 - Enter *ESSID* “Clients”
 - Clear checkbox *lan*
 - Activate checkbox *vlan101*
- Click button *Save & Apply*

5.4.5 Attach the “Staff” VLAN to radio0

- Select tab *Network* tab *WiFi*
- Click button *Add* for *radio0* (if both VLANs shall run on the same radio).

Alternatively, if the “Staff” shall use the other radio and that radio has been configured and enabled (see 7.3.3), then (instead of *Add*) select tab *Network* tab *WiFi* tab *radio1* (or click button *Edit* for *radio1*)

- In box *Interface Configuration*:
 - [Select tab *General Setup*]
 - Enter *ESSID* “Staff”
 - [Clear checkbox *lan*]
 - Activate checkbox *vlan102*
 - If needed, set checkbox *Hide ESSID*
 - Select tab *Wireless Security*
 - Select *Encryption* (e.g. WPA2-PSK)
 - Enter *Key* (at least 8 characters)
- Click button *Save & Apply*

5.4.6 Check Configuration

As a check, you may login to the CyBox GW through SSH and issue the `ifconfig` command. The following interfaces should be shown:

```
br-vlan101 Link encap:Ethernet ...
br-vlan102 Link encap:Ethernet ...

eth0 Link encap:Ethernet

inet addr:192.168.100.1 Bcast:192.168.100.255 Mask:255.255.255.0

...

eth0.100 Link encap:Ethernet

inet addr:10.0.1.128 Bcast:10.0.1.255 Mask:255.255.255.0

...

eth0.101 Link encap:Ethernet ...
eth0.102 Link encap:Ethernet ...

lo Link encap:Local Loopback ...

wlan0 Link encap:Ethernet ...
wlan0-1 Link encap:Ethernet ...
```

Oder alternativ (anstelle von wlan0-1), wenn beide Funkmodule verwendet werden:

```
wlan1 Link encap:Ethernet ...
```

5.4.7 Disable Unneeded Default Address

After successfully testing the VLAN-based management access (vlan100), the default address 192.168.100.1 may be disabled. This is easily achieved by deleting the *LAN* interface:

- Select tab *Network* tab *Interface*
- Click button *Delete* for the *LAN* interface (usually the lowermost)
- Select tab *Network* tab *Interfaces* tab *LAN*

Alternatively, you may change the protocol of the *LAN* interface to *Unmanaged*:

- Select tab *Network* tab *Interface* tab *LAN*
- In box *Common Configuration*:
 - In drop-down menu *Protocol* select *Unmanaged*
- Click button *Save & Apply*

5.5 Example: Client Isolation within the Access Point

By default, all clients of an access point can directly communicate with each other. Depending on the use case, this might be undesirable.

5.5.1 Isolate the Radio Clients

- Select tab *Network* → tab *WiFi* → tab *radio0* (or click button *Edit* for *radio0*)
- In box *Interface configuration*
 - Select tab *Advanced settings*
 - Activate checkbox *Separate clients*
- Click button *Save & Apply*
- Do the same for the other radio

5.5.2 Restrict Access to Local Ports to Specified Interfaces

- Select tab *System* tab *Administration*
- In box *Dropbear Instance*
 - Click radio button *lan*
 - [unselect radio button *unspecified*]
- Click button *Save & Apply*

This affects the mentioned port only. To protect more ports against WLAN access, use button *Add*.

Note that all interfaces listed in the *lan* field are allowed to access the respective socket.

6 THE WEB INTERFACE

Most pages of the web interface are concerned with the configuration of the CyBox GW. Many of these pages show some of the following buttons:

- **Reset**: clicking on this button reverts the unsaved input fields of the current page to the values as they were before you modified them.
- **Save**: This button copies the modified input fields of the current page to an intermediate memory. It collects changes without applying them to the CyBox GW. This is important because some changes - if applied stand-alone - could break the IP connection between host and the CyBox GW.

When clicking this button, a change count notification appears at the upper left, indicating the number of to-be-changed lines in the configuration data (The actual text in that message is kind of misleading: it claims to state the number of “unsaved changes” but actually means the number of saved but not yet applied new configuration lines.)

It should be noted, that saved data are not longer subject to the *Reset* button. Rather, saved changes - if not applied - are kept until you click the *Save & Apply* button, or the *Revert* button (see below), or CyBox GW reboots. The configuration is not yet complete as long as the change count is non-zero.

- **Revert**: Clicking on the change count message pops up an extra window showing the data exactly as they would be entered into the related configuration files. This window provides a button named *Revert*. Clicking it invalidates the saved changes and clears the change count to zero.
- **Save & Apply**: this button performs the *Save* operation (see above), modifies the configuration data according to the saved changes, and clears the change count. Please note that *Revert* and *Reset* *cannot* undo those changes after a *Save & Apply* operation! Also, depending on the specific parameters changed, networking interfaces are re-initialized with the new data. In consequence, the host-side browser might require to connect a new IP address to access the CyBox GW.
- **Submit**: Some pages provide a single *Submit* button instead of the above. Essentially, *Submit* performs an immediate *Save* operation. Thus, the change count in the upper left corner of the screen will increment. The *Save* operation also takes place when clicking special buttons like *Add new interface* or *Setup DHCP Server*. Again, the change count will change. In these cases, *Save & Apply* is needed to complete the operation.
- Buttons named *Enable* or *Disable* cause immediate execution.

6.1 Network

6.1.1 Interfaces

6.1.1.1 DHCP Server per Interface

A DHCP server can run on the device to assign IPv4 addresses to WLAN clients. It is enabled by unchecking *Disable DHCP for this interface*. However, DHCP often is managed by a dedicated DHCP server on the backbone and not directly on the access point. In that case, the DHCP server on the access point must be disabled.

6.1.1.2 Bridges

Physical network interfaces may be bridged to form a “software Ethernet switch”. For example, by bridging the `LAN 1` interface with a wireless interface, WLAN clients can communicate with LAN clients like they were connected by a switch.

To set up a bridge, use the tab `Network` → `Interfaces` → `Devices` menu. Use the `Add device configuration ...` button to set up a new Linux device as bridge type. To be compatible with older OpenWrt versions the new Linux device could be named “br-lan”.

Device	Type	MAC Address	MTU
br-lan	Bridge device	-	-
bond0	Network device	BE:34:46:F4:B7:A6	1500
bonding_masters	Network device	-	-
dummy0	Network device	CA:6A:F8:4D:A9:D7	1500
erspan0	Network device	00:00:00:00:00:00	1450
eth0	Network device	00:00:5B:00:11:22	1500
eth1	Network device	00:00:5B:00:22:33	1500
wlan0	Network device	04:F0:21:3F:2E:53	1500
wlan1	Network device	04:F0:21:3F:C6:47	1500

Bridge Interface Create

Bridge Interface Configure

The configuration specifies the wired ports to attach to this bridge. In order to attach wireless networks, choose the associated interface as network in the wireless settings.

Check Bridge interfaces and include all *Interfaces* that should belong to the new bridge interface.

In older OpenWrt version the LAN interface automatically created the physical device “br-lan” if bridging was enabled. Since this is no longer done automatically the LAN interface now should be set to *br-lan* instead of *eth0* and also to have this new bridge device in the green firewall zone.

Note that radio interfaces like *wlan0* or *wlan1* will be part of the *br-lan* bridge by selecting the LAN interface in the wireless configuration menu.

LAN Interface Status

Set LAN Interface to use physical device br-lan

Note: Physical interfaces, as eth0 or wlan0, belonging to a network interface, such as LAN, cannot be in any other network interface.

6.1.1.3 VLAN

To enable VLAN (virtual LAN, mostly used for logical subnets built on real LANs) tagging, a new custom interface must be set up for the LAN. The VLAN interfaces are named e.g. “eth0.100”. In this example “100” is the VLAN tag to be used.

VLAN interface setup

Use eth0.X as custom interface and disable eth0 as shown in the dialog above.

WARNING: After saving and applying the changes, the network output on *eth0* is tagged with your VLAN tag and the AP will not be accessible through normal network anymore. You need to enable VLAN tagging on the host interface, or connect to a switch that is able to handle this VLAN tag to be able to access the AP.

6.1.1.4 LTE

This chapter shows how to connect the CyBox GW to a mobile LTE network.

Some CyBox GW models are equipped with WLAN modules and can therefore be turned into a WLAN hotspot. Other models have LTE modems and no WLAN functionality; these can be used to connect an Ethernet-based backbone to the Internet.

6.1.1.4.1 Configuring LTE

The CyBox GW provides 4 SIM slots per LTE modem. Only one slot per modem can be active at any time. The slots can be selected via an SNMP command or using the web interface.

Note: Switching between SIM slots takes about 30 seconds, Slot 1 being preselected at power up. If you plan to use only one SIM card for a given LTE modem, it is advisable to use Slot 1 to avoid slot switching delay during the boot phase.

Before installing SIM cards, remove the SIM farm cover plate from back panel. Install the SIM cards according to the figure SIM slots on the CyBox GW. The Module 1, 2, 3, 4 and 5 correspond to the modems MODEM_S1, MODEM_S2, MODEM_S3, MODEM_S4 and MODEM_S5, respectively. If your CyBox GW might feature less than 5 modems, it might still offer 16 SIM slots, some of which are ignored. Finally, mount the cover again.

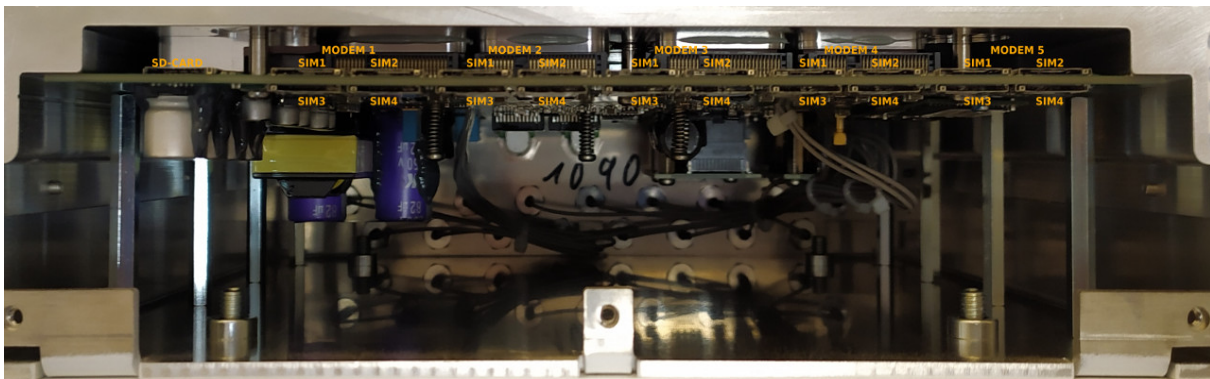

SIM slots on the CyBox GW

The LTE configuration requires the following parameters which can be requested from the LTE provider:

- PIN code of the SIM card
- APN (Access Point Name)
- Username (most often empty)
- Password (most often empty)

On the page **Network** → **Interfaces**, click the **Edit** button for the modem to be configured (e.g. Modem_S1). On the appearing page the active slot is chosen and the LTE parameters are configured (see next Figure):

The modem configuration page

- Choose the SIM slot to be used (SIM card slot). Only one SIM slot can be active at a time and here is where it is selected.
- Select Bring up on boot to activate the modem.
- In the section SIM Card Configuration, enter the configuration for each SIM card. Do so by first selecting a tab (e.g. SIM Slot 1) and then enter the corresponding configuration. Note that these tabs do no influence which SIM is actually active. For each SIM card:

The SIM slot configuration page

- Enter the **PIN** of the SIM card. Take care to enter the PIN on the correct tab, as a wrong configured **PIN** may lead to SIM card locking.
- Enter the **APN**, **Username** and **Password** as supplied by the LTE provider.
- Enter the **Allowed Authentication Method**, if the LTE provider has special requirements. The method is either PAP, CHAP or both PAP/CHAP. The default is empty, so no special requirements.
- Enter the **Alive Ping Address** if the LTE provider has special requirements. The default value is empty (means 8.8.8.8). This address should be accessible at all times for a standard internet connection.

Complete the configuration by pressing the Save & Apply button. The modem needs to be (re)started in order to re-detect the SIM card. You can do so on the [Network](#) → [Interfaces](#) page by clicking [Restart](#) for the modem. After a short while, the info box for the modem shows an IPv4 address, and any Error message in the box disappears:

MODEM_S1 is now connected

After the LTE connection was established, a “ping” test can verify that a connection to the internet is actually available. Go to [Network](#) → [Diagnostics](#) and press [Ping](#). Instead of pinging the default host “openwrt-project.org” you might as well use another one. The figure below shows a successful run of the test.

A successful “ping” test

Please refer to chapter [7.9.4 SNMP Support for LTE](#) to learn about the LTE related SNMP commands.

Now switch to the ‘Network Interface Overview’ and delete unused LAN interfaces like LAN_DHCP, LAN_MAC and LAN_ALIAS. LAN_MAC and LAN_ALIAS are using IPs in the 10.x.y.z network, which are often also used by internet service providers and may disturb routing. The LAN_DHCP should also be deleted because it may get a DHCP setup with a gateway which is not part of this MWAN configuration. You may setup a new IP for the LAN interface using a private address pool (192.168.x.y).

6.1.1.4.2 LTE Troubleshooting

Problem	Possible cause and solution
No LTE connection	Missing configuration parameters. Some providers require additional parameters for the LTE connection, namely the IP type (4 or 6) and the authentication method (PAP, CHAP or BOTH). The web interface does currently not provide means to enter these parameters; however, as a workaround, it is possible to add them to the “APN” parameter as follows: pinternet.interkom.de,ip-type=4,auth=CHAP Note that the string must not contain spaces.

LTE can reach the internet, but devices connected to it can't

1. The firewall settings might be wrong. Normally, the LTE interface should be assigned to the firewall zone "wan", while the Ethernet/WLAN interfaces should be assigned to "lan". However, depending on your firewall settings, another configuration might apply, see [6.1.6 Firewall](#) (zone-based) for details.
2. Routing conflict if LTE provider assigns private IPv4 addresses. . Some LTE providers assign IPv4 addresses within the private subnet 10.0.0.0/8. This interferes with the preconfigured interfaces which uses addresses within the same subnet (LAN_ALIAS, LAN_MAC). These interfaces should be reconfigured or deleted.

6.1.1.4.3 Modem Status Information

The extended status menu, [Status](#) → [Advanced](#) → [Modem X](#), in the web interface, can display the current modem connection status cyclically, every 10 seconds. It does not matter whether a connection to the provider has already been established. The information is queried via *qmcli* and *AT-Command* at the selected modem.

Modem 1 Status

```

RSRP: '-74 dBm'
SNR: '20.8 dB'
5G:
  RSRP: 'n/a'
  SNR: 'n/a'
  RSRQ: 'n/a'

[/dev/cdc_wdm_S1_0] Successfully got serving system:
Registration state: 'registered'
CS: 'attached'
PS: 'attached'
Selected network: '3gpp'
Radio interfaces: '1'
[0]: 'lte'
Roaming status: 'off'
Data service capabilities: '1'
[0]: 'lte'
Current PLMN:
MCC: '262'
MNC: '3'
Description: 'MEDIONmobile'
Roaming indicators: '1'
[0]: 'off' (lte)
3GPP cell ID: '17933862'
Detailed status:
Status: 'available'
Capability: 'cs-ps'
HDR Status: 'none'
HDR Hybrid: 'no'
Forbidden: 'no'
LTE tracking area code: '47021'
Full operator code info:
MCC: '262'
MNC: '3'
MNC with PCS digit: 'no'

[/dev/cdc_wdm_S1_0] Successfully got system info:
WCDMA service:
Status: 'none'
True Status: 'none'
Preferred data path: 'no'
LTE service:
Status: 'available'
  
```

Analogous to the extended Status menu, further information can be queried via the menu [System](#) → [Custom Commands](#) → [Modem Status](#). The information query is done once for all modems installed in the system.

```

# "modem_status"
===== MODEM STATUS SLOT #1 =====
[/dev/cdc_wdm_S1_0] Successfully got signal info
LTE:
  RSSI: '-41 dBm'
  RSRQ: '-10 dB'
  RSRP: '-74 dBm'
  SNR: '19.4 dB'
5G:
  RSRP: 'n/a'
  SNR: 'n/a'
  RSRQ: 'n/a'

[/dev/cdc_wdm_S1_0] Successfully got slots status
[/dev/cdc_wdm_S1_0] 2 physical slots found:
Physical slot 1:
  Card status: present
  Slot status: active
  Logical slot: 1
  ICCID: 894471AA36A8899797
  
```

6.1.1.4.4 5G

5G is the “fifth generation” of the mobile communication standard which is developed by the global initiative 3GPP. Many applications with specific demands for very low response time and faster connection requirements can be realized for the first time by using of 5G mobile broadband standard.

Some of specified mobile bands (e.g. 3.6 GHz) are already ready to use, especially in the cities. Other bands are still experimental. They will provide download/upload rates up to 100 times faster than LTE. All this by having very low latency!

5G is the next big step in the evolution of mobile communication technology!

In order to setup a 5G connection the same steps like for using of LTE have to be done (see chapter [6.1.1.4 LTE](#)).

Important

A **must** precondition to establish a 5G connection is a use of a modem with 5G capabilities as well as a SIM card with a 5G support.

6.1.2 WLAN

Wireless radios are disabled by default to avoid erroneous WLAN operation. Use [Network](#) → [Wireless](#) → [Edit](#) to enter the configuration menu. Details about WLAN configuration can be found in the next section. After configuration, enable the interfaces with [Enable](#).

Wireless Overview

radio0	Qualcomm Atheros QCA986x/988x 802.11bgnac Channel: 36 (5.180 GHz) Bitrate: ? Mbit/s SSID: System-radio0 Mode: Master BSSID: 04:F0:21:2E:49:B5 Encryption: None	Restart Scan Add Disable Edit Remove
radio1	Qualcomm Atheros QCA986x/988x 802.11bgnac Channel: 36 (5.180 GHz) Bitrate: ? Mbit/s SSID: System-radio1 Mode: Master BSSID: 04:F0:21:2E:49:BB Encryption: None	Restart Scan Add Disable Edit Remove

Associated Stations

Network	MAC-Address	Host	Signal / Noise	RX Rate / TX Rate
No information available				

Save & Appl Save Reset

Wireless Device Overview

The example shows a CyBox GW with two radios installed. Depending on the hardware, other configurations may be shown.

After enabling the radio, you can configure physical settings. Clicking [Network](#) → [Wireless](#) → [Edit](#) redirects you to the 'Device Configuration' menu.

6.1.2.1 Channel, Wireless mode, HT mode, Power settings

Advanced Settings allows to select the appropriate country in the pull-down menu. After a country change, press the *Save & Apply* button, refresh the browser page, and reboot.

Disclaimer: The wireless configuration must observe the local regulation. The upper limit of the transmission power has to be set correctly ("Transmit power"). This does not account for an antenna gain. If, for example, the regulation imposes a maximal power of 15 dBm and the gain of the antenna is 5 dBm, you must set the transmit power to a value at or below 10 dBm.

In *General Setup* you can configure wireless mode, HT mode and channel. Wireless mode can be forced to any 802.11 standard supported by the radio. The channel selection is adapted to the wireless mode chosen. The channel configuration can be set to auto but this slows down WLAN activation and requires a reboot to work properly. Therefore, it is recommended to select a defined channel.

Wireless Network: Master "System-radio0" (wlan0)

Device Configuration

General Setup | **Advanced Settings**

Status

Mode: Master | SSID: System-radio0
 BSSID: 04:F0:21:2E:49:B5
 Encryption: None
 Channel: 36 (5.180 GHz)
 Tx-Power: 23 dBm
 Signal: 0 dBm | Noise: -94 dBm
 Bitrate: 0.0 Mbit/s | Country: DE

Wireless network is enabled **Disable**

Operating frequency

Mode	Channel	Width
AC	36 (5180 Mhz)	80 MHz

Maximum transmit power driver default - Current power: 23 dBm

Specifies the maximum transmit power the wireless radio may use. Depending on regulatory requirements and wireless usage, the actual transmit power may be reduced by the driver.

Interface Configuration

General Setup | **Wireless Security** | MAC-Filter | Advanced Settings

Mode Access Point

ESSID System-radio0

Network lan: [icon]

Choose the network(s) you want to attach to this wireless interface or fill out the custom field to define a new network.

Hide ESSID

WMM Mode

Dismiss **Save**

Wireless Device Configuration

After the device has been enabled, the radio status should be checked if the selected channel / mode combination is working.

6.1.2.2 JJPlus Radio Card Band Configuration

If system is equipped with a **JJPlus Wave-2** radio module, the frequency band 2.4 GHz and 5 GHz cannot be switched on the fly (runtime) in the wireless configuration menu. After a *Factory Reset* the radio modules are configured for 5 GHz as default band. To switch to the 2.4 GHz band a **Custom Command=>Switch RadioX Band** must be executed and after that a system reboot must be triggered. The 2.4 GHz mode then, will be permanently stored in the configuration backup archive. Executing the custom command button again will toggle from 2.4 GHz to 5 GHz and vice versa. The selected mode is always stored in the configuration backup archive. Note that a band toggle will always *disable* the selected radioX. After reboot the selected radioX must be activated again and the channel/bandwidth must be configured.

JJPlus Wave-2 Frequency Band Toggle

6.1.2.3 ESSID, WDS Mode, Client separation

The ESSID is used for WLAN clients to select the wireless LAN by name. Set up a ESSID name for the wireless network in the *General Setup* of the *Interface configuration* and use mode *Access Point*.

A Wireless Distribution System (WDS) can be set up by using two access points with the same ESSID, one in “Access Point (WDS)” mode and the other in “Client (WDS)” mode. This mode is required for the Inter Carriage Connection Protocol (ICCP).

In public access point environments the client-to-client communication should be prevented by activating the *Interface Configuration* → *Advanced Settings* → *Isolate Clients* checkbox. Note that this configuration only prevents the communication between clients connected to the same access point. In a backbone with many access points having the same SSID, an additional “Client isolation” function between APs is needed (see [6.1.2.6 Multi-AP Client Isolation](#)).

6.1.2.4 Encryption

On the tab *Wireless Security* you can choose a security mode. The following modes are supported:

- WPA3 (strong security)
 - WPA3-SAE: “personal mode”, using a key (password) for access.
 - **WPA3-EAP: “enterprise mode”, using a RADIUS server for client authentication.**
- WPA2 (strong security)
 - WPA2-PSK: “personal mode”, using a password for access. Note that the cipher “TKIP” is considered insecure, and CCMP should be used instead.
 - WPA2-EAP: “enterprise mode”, using a RADIUS server for client authentication.
- WPA (medium security)
 - WPA-PSK: WPA in “personal mode”, using a password for access. Note that the cipher “TKIP” is considered insecure, and CCMP should be used instead.
 - WPA-EAP: “enterprise mode”, using a RADIUS server for client authentication.
- WEP (weak security)

- WEP Shared Key
- WEP-EAP Open System
- OWE (open, encrypted)
 - OWE: The “Opportunistic Wireless Encryption” mode requires no password, yet the WLAN traffic is encrypted. This mode is intended for public access points.
- No Encryption (open):
 - The WLAN traffic is not secured at all.

In addition, some of these modes can be combined (“mixed mode”). For an access point, this allows to support multiple modes, supporting newer encryption standards while still supported older clients. When configuring the CyBox GW as client with a “mixed mode”, it will try both modes when connecting to an access point (normally, only the configured mode is used). The following modes can be combined:

- WPA3 and WPA2 in enterprise mode (EAP)
- WPA3 and WPA2 in personal mode (PSK respective SAE)
- WPA2 and WPA in personal mode (PSK)

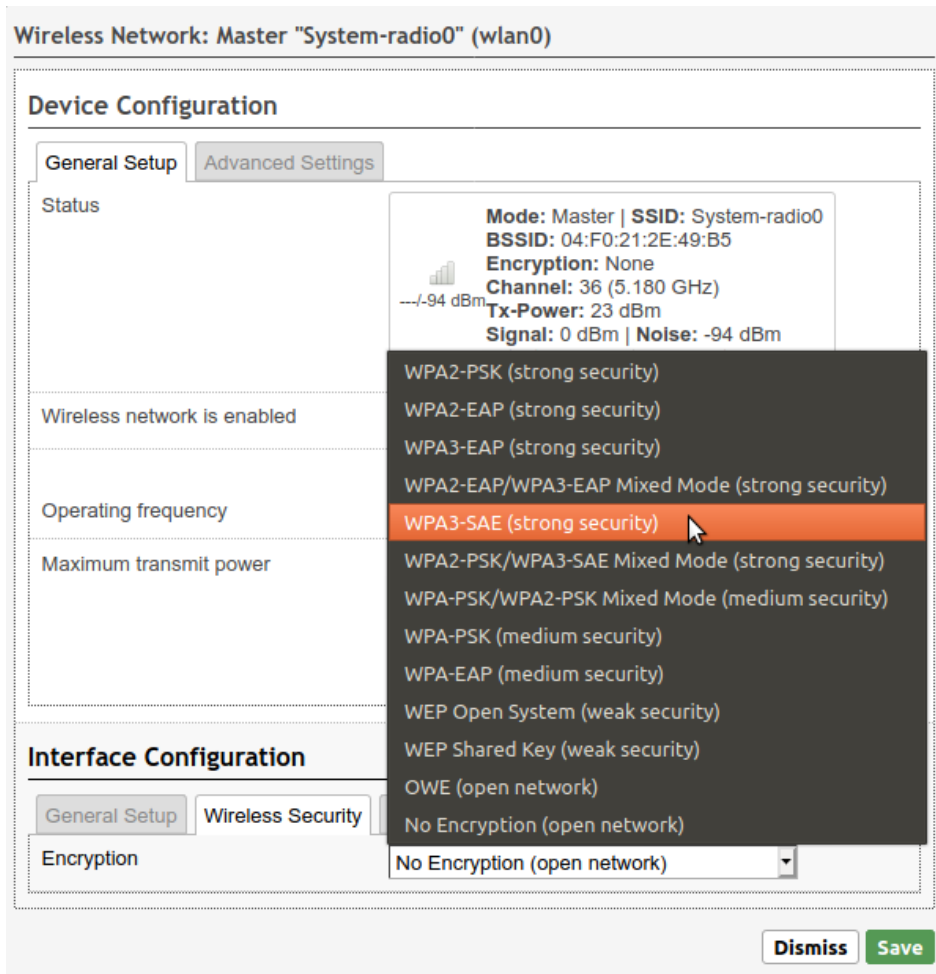

Wireless Device Configuration – Encryption Settings

6.1.2.5 Hotspot 2.0

The CyBox GW supports Hotspot 2.0 (Release 1), which is configured on the tab `Hotspot 2.0`.

Note

The `Hotspot 2.0` tab is only present if

- The WLAN is configured as AP
- The encryption mode uses RADIUS (i.e. EAP)
SP/HO

Hotspot 2.0 separates the hotspot operator from the service providers. The hotspot operator maintains the access point offering Hotspot 2.0 services while the service providers are responsible for authentication and authorization of WLAN clients. It is possible to configure multiple service providers on a single access point.

Each hotspot operator has one or more domain names, which can be configured in the `Domain Names` setting.

Service providers are identified by one of the following:

- `Consortium IDs`: **Numeric values assigned by the IEEE.** Each ID names a consortium of multiple service providers.
- `NAI Realms`: **The domain names of the service providers.** Optionally, the authentication scheme can be appended to each name. The WLAN clients can fetch this information prior before they connect.
- `3GPP Cell Identifiers`: **Each cell ID consists of the MCC and MNC** of a service provider. A mobile device can seamlessly roam between mobile networks and WLAN by identifying its mobile network provider on a Hotspot 2.0 access point.

At least one of these three parameters must be configured.

The `Operator Friendly Name` is the access point operators name. It is intended to be presented to human users of WLAN clients. Multiple entries can be configured to present the name in different languages.

The `Venue Group` and `Venue Type` settings classify the type of the venue in which the access point is installed. This might be a coffee shop, for example. The possible values are defined in IEEE Std 802.11u-2011.

The `Venue Name` might be presented to human users. It can be configured for multiple languages.

The `Network Access Type` describe the type of the offered network access. The `Internet is available` indicates whether internet access is available from this access point. Both are presented to WLAN clients before they connect.

The `ANQP Domain ID` can be used to group multiple access points which reside in the same ESS (Extended Service Set).

The `Additional ANQP Elements` setting allows to add elements.

6.1.2.6 Multi-AP Client Isolation

Client separation inhibits direct communication between clients of the same WLAN radio. However, if more than one Access Point is attached to the same cable backbone, and the wifi clients use the same subnet, client isolation must also be enabled between APs. This is also true if the CyBox GW operates multiple APs on different WLAN modules which are connected (e.g. by using a bridge). Isolation is also done for clients on different radios within the same Access Points.

In order to use Multi-AP client isolation, all APs must use the same Server and use the same interface name. (Network traffic can be restricted with a configuration for 'eatables' on FORWARD rules, managed by the 'client isolation' functionality).

For Client isolation over APs, check Network → Client Isolation → Enable, then enter parameters for your configuration.

The screenshot below shows a configuration where the server address is set in the parameters of the LAN interface (under 'Network' → 'Interfaces'). When the interface is set up as a bridge, the corresponding Bridge name is always 'br-<original_interface_name>'

<ul style="list-style-type: none"> Status System VPN Services <li style="background-color: #e0e0e0;">Network <li style="background-color: #e0e0e0;"> Interfaces <li style="background-color: #e0e0e0;"> Wireless <li style="background-color: #e0e0e0;"> DHCP and DNS <li style="background-color: #e0e0e0;"> Hostnames <li style="background-color: #e0e0e0;"> Static Routes <li style="background-color: #e0e0e0;"> Diagnostics <li style="background-color: #e0e0e0;"> Firewall <li style="background-color: #e0e0e0;"> Client Isolation <li style="background-color: #e0e0e0;"> Connection Check <li style="background-color: #e0e0e0;"> QoS <li style="background-color: #e0e0e0;"> Configure Diagnostics <li style="background-color: #e0e0e0;"> Load Balancing <li style="background-color: #e0e0e0;">Statistics <li style="background-color: #e0e0e0;">Logout 	<div style="border: 1px solid #ccc; padding: 5px;"> <h3 style="margin: 0;">Client Isolation</h3> <p style="font-size: 0.8em; margin: 0;">Network Isolation for WiFi clients on different APs connected to same backbone. Isolation is also done for clients on different radios within the same AP.</p> <hr/> <h4 style="margin: 0;">Network Isolation Settings</h4> <div style="margin-top: 10px;"> <p>Enable <input checked="" type="checkbox"/> <small>Enable client isolation service</small></p> <p>Server address list <input type="text" value="192.168.100.100 172.16.0.100"/> <small>Specifies the server or server list for MAC address requests</small></p> <p>Device <input type="text" value="br-lan"/> <small>Specifies the physical device for arping test requests</small></p> <p>SSID list to isolate <div style="border: 1px solid #ccc; padding: 2px; display: inline-block;"> -- Please choose -- CyBoxAP-2-radio0 CyBoxAP-2-radio1 </div> <small>Select one or more SSIDs for isolation rules</small></p> <p>Allowed MAC address list <input type="text"/> <small>Specifies a comma separated list of allowed MAC addresses</small></p> <p>Timeout <input type="text" value="20"/> <small>Maximum time in seconds to wait for server reaction</small></p> <p>Wait time <input type="text" value="120"/> <small>Time in seconds to wait before a new server list scan starts</small></p> <p style="text-align: right; margin-top: 10px;"> <input type="button" value="Save & Apply"/> <input type="button" value="Save"/> <input type="button" value="Reset"/> </p> </div> </div>
--	--

Client isolation across access points

6.1.2.7 Connection Check

The connection check service allows to disable WLANs while no internet connectivity is possible. This can improve the user experience by avoiding being connected to a WLAN which delivers no internet connectivity.

The connection check works by issuing an *arping* to the server. When the server cannot be reached, the WLAN gets deactivated. Otherwise, the WLAN gets activated. The service can be configured on the page Network → Connection Check (see figure “Deactivate SSIDs when the server is not reachable” below). The checkbox **Enable** enables or disables it.

The parameter **Server address** determines which address is arpinged to determine whether the connection is healthy. The parameter **Interface name** dictates which interface to use for the arping. Note that this is a physical interface, such as `br-lan` or `eth0`.

In the **SSID list**, the controlled SSIDs can be chosen. The selected SSIDs are activated or deactivated by the service, while the others remain unaffected.

The connection is checked every **Check time interval** seconds. The selected SSIDs are disabled when the connection was down for at least **Shutdown time** seconds, and they are enabled again when the connection was healthy for at least **Activate time** seconds. Note that the latter two work at the granularity of **Check time interval**: If **Check time interval** → 15s and **Activate time** → 20s, the WLANs will be activated after the 2nd successful check, i.e. after 30s.

Status	Connection Check														
System	Connection Check allows to enable/disable wifi SSIDs depending on server accessibility														
VPN															
Services	Connection Check Settings														
Network	<table border="1"> <tr> <td>Enable</td> <td> <input checked="" type="checkbox"/> Enable connection check for specified SSIDs </td> </tr> <tr> <td>Server address</td> <td> <input type="text" value="192.168.100.100"/> <small>Specifies the server for MAC address requests</small> </td> </tr> <tr> <td>Interface name</td> <td> <input type="text" value="br-lan"/> <small>Specifies the interface for arping test requests</small> </td> </tr> <tr> <td>SSID list</td> <td> <div style="border: 1px solid #ccc; padding: 2px;"> -- Please choose -- CyBoxAP-2-radio0 CyBoxAP-2-radio1 </div> <small>Select one or more SSIDs for connection check</small> </td> </tr> <tr> <td>Check time interval</td> <td> <input type="text" value="20"/> <small>Wait time (seconds) between two connection checks</small> </td> </tr> <tr> <td>Activate time</td> <td> <input type="text" value="60"/> <small>Wait time (seconds) before wifi is activated after connection valid</small> </td> </tr> <tr> <td>Shutdown time</td> <td> <input type="text" value="60"/> <small>Wait time (seconds) before wifi shutdown after connection invalid</small> </td> </tr> </table>	Enable	<input checked="" type="checkbox"/> Enable connection check for specified SSIDs	Server address	<input type="text" value="192.168.100.100"/> <small>Specifies the server for MAC address requests</small>	Interface name	<input type="text" value="br-lan"/> <small>Specifies the interface for arping test requests</small>	SSID list	<div style="border: 1px solid #ccc; padding: 2px;"> -- Please choose -- CyBoxAP-2-radio0 CyBoxAP-2-radio1 </div> <small>Select one or more SSIDs for connection check</small>	Check time interval	<input type="text" value="20"/> <small>Wait time (seconds) between two connection checks</small>	Activate time	<input type="text" value="60"/> <small>Wait time (seconds) before wifi is activated after connection valid</small>	Shutdown time	<input type="text" value="60"/> <small>Wait time (seconds) before wifi shutdown after connection invalid</small>
Enable	<input checked="" type="checkbox"/> Enable connection check for specified SSIDs														
Server address	<input type="text" value="192.168.100.100"/> <small>Specifies the server for MAC address requests</small>														
Interface name	<input type="text" value="br-lan"/> <small>Specifies the interface for arping test requests</small>														
SSID list	<div style="border: 1px solid #ccc; padding: 2px;"> -- Please choose -- CyBoxAP-2-radio0 CyBoxAP-2-radio1 </div> <small>Select one or more SSIDs for connection check</small>														
Check time interval	<input type="text" value="20"/> <small>Wait time (seconds) between two connection checks</small>														
Activate time	<input type="text" value="60"/> <small>Wait time (seconds) before wifi is activated after connection valid</small>														
Shutdown time	<input type="text" value="60"/> <small>Wait time (seconds) before wifi shutdown after connection invalid</small>														
	<input type="button" value="Save & Apply"/> <input type="button" value="Save"/> <input type="button" value="Reset"/>														

Deactivate SSIDs when the server is not reachable

6.1.2.8 Access Point Scanning Service (Wireless Monitoring)

Reporting nearby APs to interested parties

Important

A **must** precondition to use this service is to have at least one available radio device running AP (AccessPoint) mode. Please make sure, such configuration is done and running **before** activating this service. Otherwise no scanning results can be obtained.

Since service is activated (enabled), scanning is done continuously in the background. All channels of selected radio device(s) are scanned one after another. Scan results are stored to a temporarily FIFO queue and can be obtained anytime.

The scanning service is configurable over UCI resp. LUCI. A separate page (Services -> AP Scanner) can be used to configure radio devices which are used for scanning. Also the interval between scanning cycles and the maximum queue length can be configured.

Important

System load and network traffic caused by SNMP calls can be minimized by using of SSID filter parameters. As long SSID filter is enabled, only entries matching the predefined filter will be stored to a result queue.

Status	Wireless Monitoring	
System	Settings	
VPN		
Services	<input checked="" type="checkbox"/> Enable	
Customize	Radio interface list (Access Point)	-- Please choose -- radio0
SNMPD	<input type="checkbox"/> Select one or more radios for scanning	
SNMPD Edit	Activate SSID Filter	disable
SNMP-Trap	Interval between scanning cycles (seconds)	5
GPS Info	Data Queue length	1000
GPSD	<input type="button" value="Save & Apply"/> <input type="button" value="Save"/> <input type="button" value="Reset"/>	
Shadowsocks-libev		
SMS Command		
ICCP		
AP Scanner		

Scanning results can be obtained by a SNMP request. Getting queue entry from remote host

```
~# snmpget -c public -v 2c <device_ip> 1.3.6.1.4.1.2021.8.1.2.159.101.1;
iso.3.6.1.4.1.2021.8.1.2.159.101.1 =
STRING: "00:15:61:20:AC:8A;CyBoxGW-P-radio1;04:F0:21:3F:2E:AA;36;-27;2020-05-06 13:20:17"
```

In case of empty queue response will be a "nil" value.

```
~# snmpget -c public -v 2c <device_ip> 1.3.6.1.4.1.2021.8.1.2.159.101.1;
iso.3.6.1.4.1.2021.8.1.2.159.101.1 = STRING: "nil"
```

Important

As soon queue has reached the configured maximum length, every time there is a new entry added to queue the "oldest" one will be dropped!

How to avoid data lost?

1. increase maximum queue length
2. collect sampled data more often e.g. once a second (snmp request)

Scanning results are stored in CSV format:

- S_BSSID (MAC of scanner radio)
- SSID (the name)
- BSSID (the MAC)
- channel
- signal level
- "last seen" timestamp

Current queue status (entries) can be also discovered on the UI page (Status->AP Scanner).

Status	Scanner Results
Overview	"00:15:61:20:AC:8A;DIRECT-29-HP OfficeJet 6950;C8:D9:D2:C7:DB:2A;6;-86;2021-01-11 11:36:28",
Advanced	"00:15:61:20:AC:8A;HR;90:72:40:22:23:48;6;-76;2021-01-11 11:36:28",
Firewall	"00:15:61:20:AC:8A;devoLo-0b2;30:D3:2D:B7:D0:B2;8;-84;2021-01-11 11:36:29",
Routes	"00:15:61:20:AC:8A;Telekom FON;4C:1B:86:A3:12:46;11;-91;2021-01-11 11:36:29",
System Log	"00:15:61:20:AC:8A;FRITZ!Box Gastzugang;0A:96:D7:2A:B7:91;11;-90;2021-01-11 11:36:29",
Kernel Log	"00:15:61:20:AC:8A;Westerwald;08:96:D7:2A:B7:91;11;-90;2021-01-11 11:36:29",
Processes	"00:15:61:20:AC:8A;WLAN-344368;D4:21:22:9F:86:F3;1;-85;2021-01-11 11:36:35",
Realtime Graphs	"00:15:61:20:AC:8A;vmn;3C:A6:2F:26:9D:5D;1;-53;2021-01-11 11:36:35",
AP Scanner	"00:15:61:20:AC:8A;vmn;3C:A6:2F:B9:F8:2C;1;-72;2021-01-11 11:36:35",
Rogue AP	"00:15:61:20:AC:8A;vmn;24:65:11:3D:9E:CE;1;-85;2021-01-11 11:36:35",
System	"00:15:61:20:AC:8A;WLAN-344368;F0:B0:14:F3:C3:09;1;-89;2021-01-11 11:36:35",
VPN	"00:15:61:20:AC:8A;Zorni;E0:28:6D:BA:67:D9;1;-89;2021-01-11 11:36:35",
Services	"00:15:61:20:AC:8A;PowerFernseher;24:65:11:CF:A9:5C;1;-87;2021-01-11 11:36:35",
Network	"00:15:61:20:AC:8A;Telekom FON;9C:C1:72:D5:17:01;1;-90;2021-01-11 11:36:35",
Statistics	"00:15:61:20:AC:8A;SHFUNK;9C:C1:72:D5:17:00;1;-90;2021-01-11 11:36:35",
	"00:15:61:20:AC:8A;HR;D0:03:4B:65:D8:DA;1;-91;2021-01-11 11:36:35",
	"00:15:61:20:AC:8A;Ulli;7C:FF:4D:E4:5E:8A;1;-88;2021-01-11 11:36:35",
	"00:15:61:20:AC:8A;DIRECT-29-HP OfficeJet 6950;C8:D9:D2:C7:DB:2A;6;-87;2021-01-11 11:36:36",
	"00:15:61:20:AC:8A;HR;90:72:40:22:23:48;6;-75;2021-01-11 11:36:36",
	"00:15:61:20:AC:8A;devoLo-0b2;30:D3:2D:B7:D0:B2;8;-84;2021-01-11 11:36:37",
	"00:15:61:20:AC:8A;Telekom FON;4C:1B:86:A3:12:46;11;-90;2021-01-11 11:36:38",
	"00:15:61:20:AC:8A;FRITZ!Box Gastzugang;0A:96:D7:2A:B7:91;11;-91;2021-01-11 11:36:38",
	"00:15:61:20:AC:8A;Westerwald;08:96:D7:2A:B7:91;11;-90;2021-01-11 11:36:38",
	"00:15:61:20:AC:8A;BVB09;4C:1B:86:A3:12:44;11;-90;2021-01-11 11:36:38",
	}

6.1.2.9 Client Counting Service

Reporting nearby Clients to interested parties

Important

A **must** precondition to use this service is to have at least one available radio device running AP (AccessPoint) mode. Please make sure, such configuration is done and running **before** activating this service. Otherwise no sniffed results can be obtained.

Since the service is activated (enabled), sniffing is done continuously in the background. A special monitor device is created for selected radio interface(s). Data received by radio interface (AP) also goes through the monitor device. Probe Requests sent by clients around the monitor device are used for definitely client identification. Sniffed personal data (MAC and SSID) have to be protected according to the requirements of personal data protection regulations (DSGVO). Encryption algorithm uses additional String (Pepper), configured by user, to achieve better anonymization results. Also there is a mechanism to encrypt personal data up to multiple times (hash_count). Results are stored to a temporarily FIFO queue and can be obtained anytime.

The sniffing service is configurable over UCI resp. LUCI. A separate page (Services -> WLAN Sniffer) can be used to configure radio devices which are used for sniffing. Also the maximum queue length, additional string and hash cycle count values can be configured.

Status	WLAN Client Counting	
System	Settings	
VPN		
Services		
Customize		
SNMPD		
SNMPD Edit		
SNMP-Trap		
GPS Info		
GPSD		
Rouge AP		
ICCP		
Wlan Sniffer		
Softflowd		

Enable

Radio interface list (Access Point)

Select one or more radios for sniffing

Data Queue length

Hash String (Pepper)

Hash cycle count

Results can be obtained by a SNMP request. Getting queue entry from remote host.

```
~# snmpget -c public -v 2c <device_ip> 1.3.6.1.4.1.2021.8.1.2.160.101.1;
iso.3.6.1.4.1.2021.8.1.2.160.101.1 =
STRING: "radiol;
c78236b5fb56b9023249e23e94dae7092aaa16f792aa168b21c064713b9883fe;
n/a;
-29dBm;
2020-05-07 09:25:20"
```

In case of empty queue response will be a "nil" value.

```
~# snmpget -c public -v 2c <device_ip> 1.3.6.1.4.1.2021.8.1.2.160.101.1;
iso.3.6.1.4.1.2021.8.1.2.160.101.1 = STRING: "nil"
```

Important

As soon queue has reached the configured maximum length, every time there is a new entry added to queue the "oldest" one will be dropped!

How to avoid data lost?

1. increase maximum queue length
2. collect sampled data more often e.g. once a second (snmp request)

Sniffed results are stored in CSV format:

- radio device (which is used for sniffing e.g. radio0)
- MAC
- SSID (n/a for empty SSID)
- RSSI (signal level in dBm)
- "last seen" timestamp

Current queue status (entries) can be also discovered on the UI page (Status -> WLAN Sniffer).

Status	Sniffer Results
Overview	"radio1;c78236b5fb56b9023249e23e94dae7092aaa16f792aa168b21c064713b9883fe;n/a;-28dBm;2020-05-07 09:29:20"
Advanced	"radio1;f90a65957f2614491cc72284db4689020b2dbca102a237d0e94c10b7445cb4a4;n/a;-17dBm;2020-05-07 09:29:36"
Firewall	"radio1;c78236b5fb56b9023249e23e94dae7092aaa16f792aa168b21c064713b9883fe;n/a;-30dBm;2020-05-07 09:29:53"
Routes	"radio1;c78236b5fb56b9023249e23e94dae7092aaa16f792aa168b21c064713b9883fe;n/a;-30dBm;2020-05-07 09:29:54"
System Log	"radio1;f90a65957f2614491cc72284db4689020b2dbca102a237d0e94c10b7445cb4a4;n/a;-16dBm;2020-05-07 09:30:10"
Kernel Log	"radio1;c78236b5fb56b9023249e23e94dae7092aaa16f792aa168b21c064713b9883fe;n/a;-29dBm;2020-05-07 09:30:28"
Processes	"radio1;c78236b5fb56b9023249e23e94dae7092aaa16f792aa168b21c064713b9883fe;n/a;-30dBm;2020-05-07 09:30:29"
Realtime Graphs	"radio1;f90a65957f2614491cc72284db4689020b2dbca102a237d0e94c10b7445cb4a4;n/a;-17dBm;2020-05-07 09:30:44"
Rogue AP	"radio1;c78236b5fb56b9023249e23e94dae7092aaa16f792aa168b21c064713b9883fe;n/a;-28dBm;2020-05-07 09:31:02"
Wlan Sniffer	"radio1;c78236b5fb56b9023249e23e94dae7092aaa16f792aa168b21c064713b9883fe;n/a;-28dBm;2020-05-07 09:31:03"
Load Balancing	"radio1;f90a65957f2614491cc72284db4689020b2dbca102a237d0e94c10b7445cb4a4;n/a;-16dBm;2020-05-07 09:31:18"
System	"radio1;c78236b5fb56b9023249e23e94dae7092aaa16f792aa168b21c064713b9883fe;n/a;-29dBm;2020-05-07 09:31:36"
VPN	"radio1;c78236b5fb56b9023249e23e94dae7092aaa16f792aa168b21c064713b9883fe;n/a;-29dBm;2020-05-07 09:31:37"
Services	"radio1;f90a65957f2614491cc72284db4689020b2dbca102a237d0e94c10b7445cb4a4;n/a;-18dBm;2020-05-07 09:31:53"
Network	"radio1;c78236b5fb56b9023249e23e94dae7092aaa16f792aa168b21c064713b9883fe;n/a;-25dBm;2020-05-07 09:32:11"
Statistics	"radio1;c78236b5fb56b9023249e23e94dae7092aaa16f792aa168b21c064713b9883fe;n/a;-25dBm;2020-05-07 09:32:12"
	"radio1;f90a65957f2614491cc72284db4689020b2dbca102a237d0e94c10b7445cb4a4;n/a;-16dBm;2020-05-07 09:32:27"
	"radio1;c78236b5fb56b9023249e23e94dae7092aaa16f792aa168b21c064713b9883fe;n/a;-25dBm;2020-05-07 09:32:45"
	"radio1;c78236b5fb56b9023249e23e94dae7092aaa16f792aa168b21c064713b9883fe;n/a;-26dBm;2020-05-07 09:32:46"
	"radio1;f90a65957f2614491cc72284db4689020b2dbca102a237d0e94c10b7445cb4a4;n/a;-13dBm;2020-05-07 09:33:01"
	"radio1;c78236b5fb56b9023249e23e94dae7092aaa16f792aa168b21c064713b9883fe;n/a;-23dBm;2020-05-07 09:33:19"
	"radio1;c78236b5fb56b9023249e23e94dae7092aaa16f792aa168b21c064713b9883fe;n/a;-23dBm;2020-05-07 09:33:20"
	"radio1;f90a65957f2614491cc72284db4689020b2dbca102a237d0e94c10b7445cb4a4;n/a;-11dBm;2020-05-07 09:33:36"
	"radio1;c78236b5fb56b9023249e23e94dae7092aaa16f792aa168b21c064713b9883fe;n/a;-29dBm;2020-05-07 09:33:54"

6.1.2.10 Rogue Access Point Detection Service

This service is used to detect unauthorized Access Points nearby and scans nearby access points and classifies them as “rogue” or “not rogue”. The rogue APs are reported via SNMP traps.

Important

The rogue AP detection algorithm relies on the [8 THE FLYING CONTROLLER MECHANISM](#). The detection algorithm is only active on devices running in **controller** mode. As the controller mode selection is done automatically between devices running in the same network (LAN), all potentially candidates for Rogue AP detection have to be configured identically.

Multiple devices can take part on rogue access point detection. Every device running the AP scanning service and Flying Controller services and connected to the common wired network can be used as a part of the detection network. All scanned data from detection participants are requested by the controller device via SNMP calls and used for rogue AP detection.

Important

The rogue AP detection algorithm relies on the [6.1.2.8 Access Point Scanning Service \(Wireless Monitoring\)](#) running on all participating devices.

As long as an SSID filter is enabled, only entries matching the predefined filter will be used during for detection. Known authorized devices can be whitelisted by using of whitelist parameter. Participants of the common network (i.e. the workers of the flying controller mechanism) are whitelisted automatically.

Important

System load and network traffic caused by SNMP calls can be minimized by using of SSID filter parameters. This also can be done for AP Scanner Service.

Participants connected to the wired network (all workers and the controller itself) are automatically whitelisted by service and not recognized as rogue devices. All other scanned APs with the same SSID will be declared as rogue and reported to a specified host. These notifications can be enabled with parameter "Enable SNMP Traps". IP address of the SNMP trap receiver can be configured with the parameter "Target address."

Status	Rogue AP Detection
System	
VPN	
Services	Settings
Customize	Enable <input checked="" type="checkbox"/>
SNMPD	Activate SSID Filter <input type="text" value="enable"/>
SNMPD Edit	SSID Filter <input type="text" value="vmn_i"/> <input type="text" value="SSID"/>
SNMP-Trap	Whitelist <input type="text" value="disable"/>
GPS Info	Interval between detection cycles (seconds) <input type="text" value="30"/>
GPSD	Enable SNMP-Traps <input checked="" type="checkbox"/>
Shadowsocks-libev	Target address <input type="text" value="192.168.100.180"/>
SMS Command	<input type="checkbox"/> Specifies the server for SNMP-Traps
ICCP	
AP Scanner	
OMR-Tracker	
Rogue AP	<input type="button" value="Save & Apply"/> <input type="button" value="Save"/> <input type="button" value="Reset"/>

SNMP notifications are defined within the Westermo Eltec MIB and have following format:

```
ELTEC-CYAP-MIB::rogueAPdetected
ELTEC-CYAP-MIB::rogueDataSSID
ELTEC-CYAP-MIB::rogueDataBSSID
ELTEC-CYAP-MIB::rogueDataChannel
ELTEC-CYAP-MIB::rogueDataSignal
ELTEC-CYAP-MIB::rogueDataLastseen
ELTEC-CYAP-MIB::rogueDataSBSSID
```

Status messages can be discovered on the UI page (Status->RogueAP).

Status	Results
Overview	Mon Jan 11 11:44:27 2021 daemon.err uhttpd[9057]: luci: accepted login on /admin/status/rogueap for root from 192.168.100.180
Advanced	Mon Jan 11 11:44:31 2021 user.info rogueap: Starting up
Firewall	Mon Jan 11 11:44:31 2021 user.info rogueap: interval = 30 seconds.
Routes	Mon Jan 11 11:44:31 2021 user.info rogueap: verbosity_level = 2
System Log	Mon Jan 11 11:44:31 2021 user.info rogueap: trap_enable = 1
Kernel Log	Mon Jan 11 11:44:31 2021 user.info rogueap: target_addr = 192.168.100.180
Processes	Mon Jan 11 11:44:31 2021 user.info rogueap: device state changed [unused]->[controller]
Realtime Graphs	Mon Jan 11 11:50:51 2021 user.info rogueap: detected 5 BSSID[00:15:61:20:AC:8A] SSID[vmn_i] BSSID[C6:D7:31:3F:87:44] CHANNEL[1] SIGNAL[-45]
AP Scanner	Mon Jan 11 11:51:26 2021 user.info rogueap: detected 5 BSSID[00:15:61:20:AC:8A] SSID[vmn_i] BSSID[C6:D7:31:3F:87:44] CHANNEL[1] SIGNAL[-45]
Rogue AP	Mon Jan 11 11:51:26 2021 user.info rogueap: detected 5 BSSID[00:15:61:20:AC:8A] SSID[vmn_i] BSSID[6A:74:22:9C:3C:8B] CHANNEL[1] SIGNAL[-41]

6.1.3 Multi-WAN Manager (MWAN3)

Important

Since MWAN3 and LinkAggregation are concurrent routing features, only one of them can be active at the same time. Please refer to chapter [OpenMPTCProuter versus MWAN3](#).

The multi-WAN manager (MWAN3) can be used to control which network connection is to be used for traffic. This section uses LTE uplink connections as example, but other connections - like WLAN or Ethernet - can also be used.

It provides the following features:

- Monitoring of WAN connectivity using repeated ping tests (ping | arping | httping).
- Routing of outbound traffic to another WAN interface if the first WAN interface loses connectivity, based on metric. The connection with the lowest metric is preferred, other connections are only used if the preferred one fails. Interfaces sharing the same metric value form a “group”.
- Outbound WAN traffic load balancing over multiple WAN interfaces based on a numeric weight assignment. All connections sharing the same metric (“within the same group”) are used simultaneously, distributing traffic over them. Connections with higher weights gets more traffic assigned.
- Different policies can be defined for different traffic types. For example, OpenVPN traffic could be routed through the first connection (using the other connections only if it fails), while routing all other traffic through the remaining connections (using load-balancing among them).

Load-balancing requires no remote station on the ground, it is handled entirely by the CyBox GW. As such, it is no link aggregation. It distributes traffic by streams, not by packets, i.e. a single stream cannot benefit from multiple LTE connections. For example, a single download stream can only use one LTE connection. However, multiple streams (e.g. generated by many WLAN users onboard a train) can be distributed over multiple WAN connections, increasing the overall bandwidth.

The figure Example traffic flow in MWAN shows an example configuration and visualizes the traffic flows in various situations:

- When all interfaces are up, all traffic is routed through the interface with the lowest metric, which is LTE 1 (metric=0).
- If LTE 1 fails, all traffic is still routed through the operable interfaces with the lowest metric (=1). But now, this is LTE 2 and LTE 3, which share the same metric. The traffic is distributed (load-balanced) over these interfaces.
- If LTE 1 and 2 fail, the traffic is routed over LTE 3, because this is now the operable interface with the lowest metric. There is no load-balancing any more, because only one interface is used.
- If LTE 1-3 fail, LTE 4 is used. Technically it is the operable interface with the lowest metric.

Note that the load balancing between LTE 2 and LTE 3 routes more traffic through LTE 3 than through LTE 2. This is because of the different weights. The interface with the higher weight gets more traffic. When there is now load balancing, the weight values have no effect.

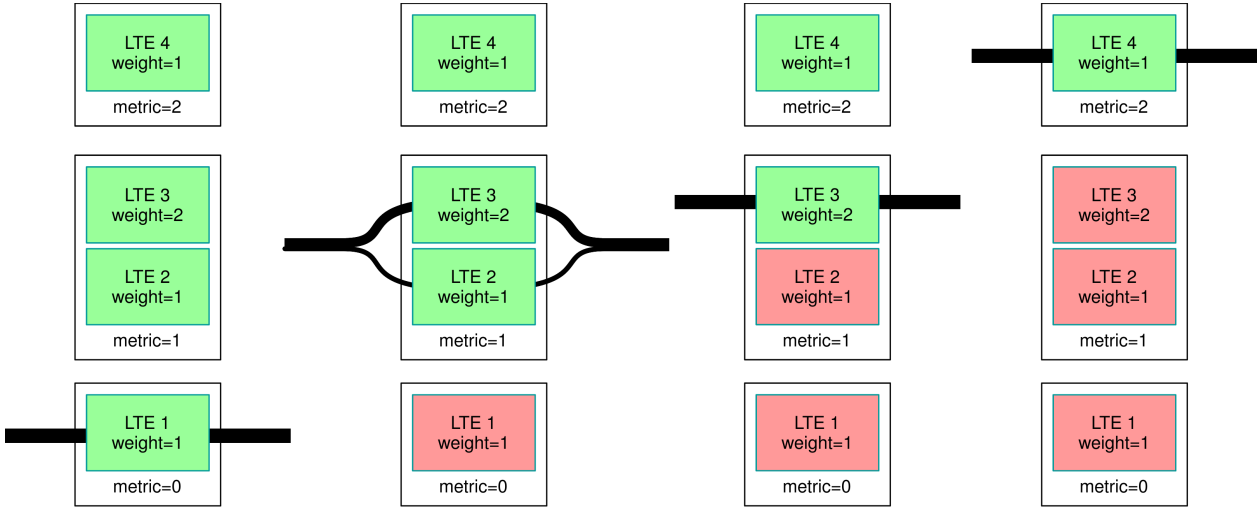

All interfaces up

LTE 1 failed

LTE 1 and 2 failed

LTE 1-3 failed

Example traffic flow in MWAN

6.1.3.1 Capabilities

The MWAN3 package provides the following capabilities:

- provides outbound WAN traffic load balancing over multiple WAN interfaces based on a numeric weight assignment
- monitors WAN connections using repeated ping tests (ping | arping | httping) and automatically routes outbound traffic to another WAN interface if the first WAN interface loses connectivity
- provides specific outbound traffic rules to customize which outbound connections should use which WAN interface

6.1.3.2 MWAN Test

6.1.3.2.1 Gateway

After complete Modem setup the modem interfaces are up and tracking via ping is active. To check the hotplug MWAN mechanism open a second web interface to CyBox GW and go to **Network** → **Interfaces**.

In this example MODEM_S1 has the lowest metric and will be first standard gateway. The test is started with **Stop** action on interface MODEM_S1.

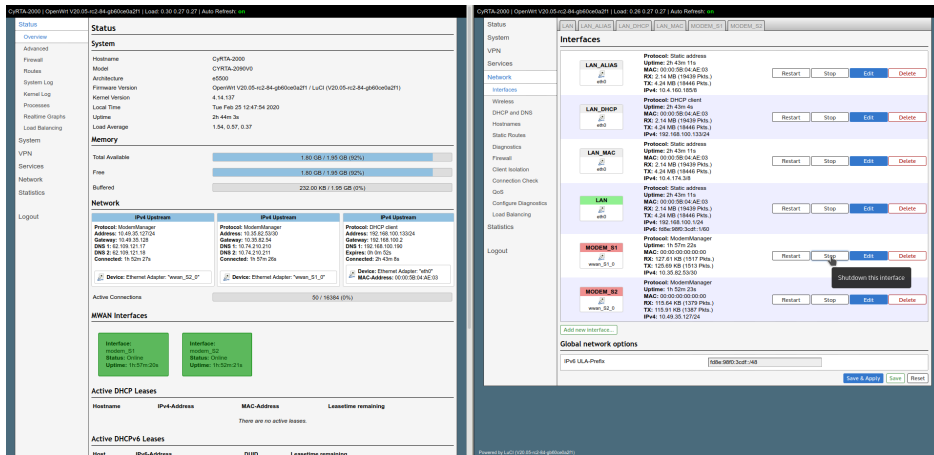

MWAN test stopping a modem

As the interface is down, all traffic has stopped and standard gateway switches to modem1.

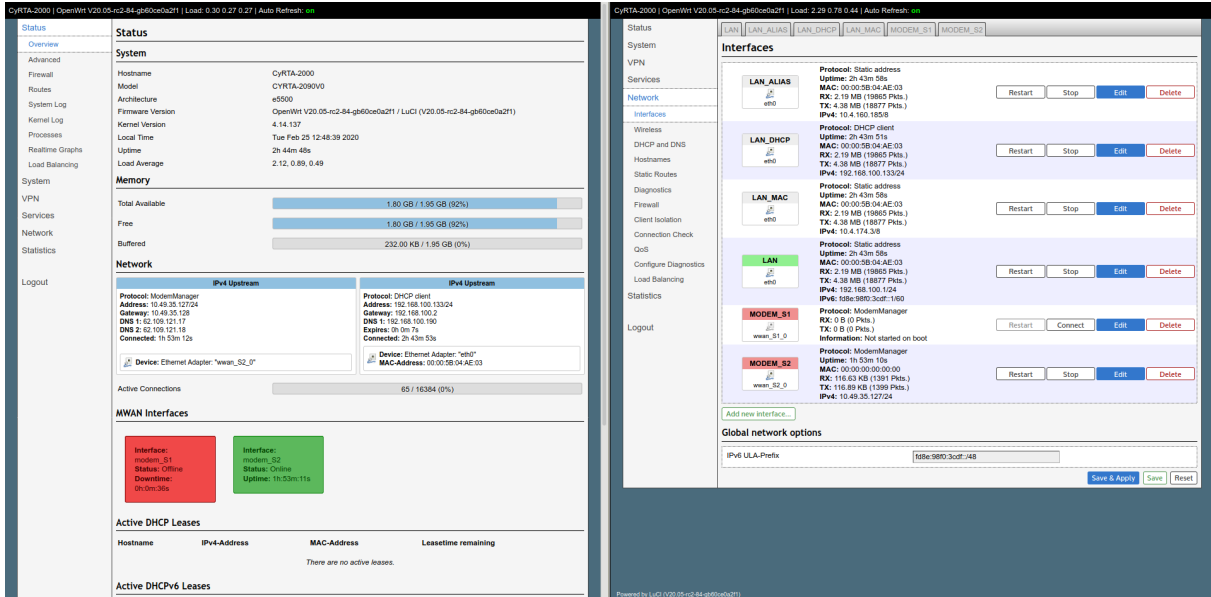

MWAN test

6.1.3.3 MWAN Status

The detailed MultiWan status information is found in Status → Load Balancing → Detail.

Status	Interface Detail Diagnostics Troubleshooting
<ul style="list-style-type: none"> Overview Advanced Firewall Routes System Log Kernel Log Processes Realtime Graphs <li style="background-color: #e0e0e0;">Load Balancing System VPN Services Network Statistics Logout 	<div style="border-bottom: 1px solid black; padding-bottom: 5px;"> <h2 style="margin: 0;">MWAN Status - Detail</h2> </div> <p>Interface status: interface modem_S1 is offline and tracking is active interface modem_S2 is online and tracking is active</p> <p>Current ipv4 policies: balanced: modem_S2 (100%) modem_S1 modem_S2: modem_S2 (100%) modem_S1 only: unreachable modem_S2 modem_S1: modem_S2 (100%) modem_S2 only: modem_S2 (100%)</p> <p>Current ipv6 policies: balanced: unreachable modem_S1 modem_S2: unreachable modem_S1 only: unreachable modem_S2 modem_S1: unreachable modem_S2 only: unreachable</p> <p>Directly connected ipv4 networks: 192.168.100.255 10.35.82.53 127.0.0.0 192.168.100.133 10.49.35.0/24 192.168.100.1 10.49.35.255 10.0.0.0/8 10.49.35.0 10.0.0.0 192.168.100.0 192.168.100.0/24 10.35.82.55 10.255.255.255 10.4.174.3 10.35.82.52/30 10.35.82.52 127.0.0.1 224.0.0.0/3 127.255.255.255 10.4.160.185 10.49.35.127 127.0.0.0/8</p> <p>Directly connected ipv6 networks: fd8e:98f0:3cdf::/64 f-00::/64</p>

MWAN detailed status page

6.1.3.4 MWAN Modem Interface Configuration

The MWAN interface configuration has a default setup for every modem card.

Status
Globals
Interfaces
Members
Policies
Rules
Notification

System

VPN

Services

Network

Interfaces

Wireless

DHCP and DNS

Hostnames

Static Routes

Diagnostics

Firewall

Client Isolation

Connection Check

QoS

Configure Diagnostics

Load Balancing

Statistics

Logout

MWAN - Interfaces

There are currently 2 of 60 supported interfaces configured
WARNING: Interface modem_S1 has no default route in the main routing table

MWAN supports up to 252 physical and/or logical interfaces
 MWAN requires that all interfaces have a unique metric configured in /etc/config/network
 Names must match the interface name found in /etc/config/network
 Names may contain characters A-Z, a-z, 0-9, _ and no spaces
 Interfaces may not share the same name as configured members, policies or rules

Name	Enabled	Tracking method	Tracking method	Tracking reliability	Ping interval	Interface down	Interface up	Metric		
modem_S1	Yes	ping	—	1	5s	3	8	10	Edit	Delete
modem_S2	Yes	ping	—	1	5s	3	8	20	Edit	Delete

Add

Save & Apply
Save
Reset

MWAN Interface configuration

The tracking parameters can handle target host IPs, ping interval and timeout.

<ul style="list-style-type: none"> Status System VPN Services Network Interfaces Wireless DHCP and DNS Hostnames Static Routes Diagnostics Firewall Client Isolation Connection Check QoS Configure Diagnostics Load Balancing Statistics Logout 	Globals Interfaces Members Policies Rules Notification	
	<h3 style="text-align: center;">MWAN Interface Configuration - modem_S1</h3>	
	Enabled	<input checked="" type="checkbox"/>
	Initial state	Online
		<input checked="" type="checkbox"/> Expect interface state on up event
	Internet Protocol	IPv4
	Tracking hostname or IP address	8.8.8.8 <input type="text"/>
		208.67.220.220 <input type="text"/>
		<input type="text"/> <input type="button" value="+"/>
		<input checked="" type="checkbox"/> This hostname or IP address will be pinged to determine if the link is up or down. Leave blank to assume interface is always online
	Tracking method	ping
	Tracking reliability	1
		<input checked="" type="checkbox"/> Acceptable values: 1-100. This many Tracking IP addresses must respond for the link to be deemed up
	Ping count	1
	Ping size	56
	Max TTL	60
	Check link quality	<input type="checkbox"/>
	Ping size	56
	Ping timeout	2 seconds
	Ping interval	5 seconds
Failure interval	5 seconds	
	<input checked="" type="checkbox"/> Ping interval during failure detection	
Keep failure interval	<input type="checkbox"/>	
	<input checked="" type="checkbox"/> Keep ping failure interval during failure state	
Recovery interval	5 seconds	
	<input checked="" type="checkbox"/> Ping interval during failure recovering	
Interface down	3	
	<input checked="" type="checkbox"/> Interface will be deemed down after this many failed ping tests	
Interface up	5	

Tracking parameters

6.1.3.5 MWAN Members Configuration

Members are profiles attaching a metric and weight to an MWAN interface. Names may contain characters A-Z, a-z, 0-9, _ and no spaces. Members may not share the same name as configured interfaces, policies or rules.

Status

System

VPN

Services

Network

Interfaces

Wireless

DHCP and DNS

Hostnames

Static Routes

Diagnostics

Firewall

Client Isolation

Connection Check

QoS

Configure Diagnostics

[Load Balancing](#)

Statistics

Logout

Globals
Interfaces
Members
Policies
Rules
Notification

MWAN - Members

Members are profiles attaching a metric and weight to an MWAN interface
Names may contain characters A-Z, a-z, 0-9, _ and no spaces
Members may not share the same name as configured interfaces, policies or rules

Name	Interface	Metric	Weight				
modem_S1_m1_w3	modem_S1	1	3	Up	Down	Edit	Delete
modem_S1_m2_w3	modem_S1	2	3	Up	Down	Edit	Delete
modem_S2_m1_w2	modem_S2	1	2	Up	Down	Edit	Delete
modem_S2_m2_w2	modem_S2	2	2	Up	Down	Edit	Delete

Add

Save & Apply
Save
Reset

MWAN members

6.1.3.6 MWAN Policies Configuration

Policies are profiles grouping one or more members controlling how MWAN distributes traffic. Member interfaces with lower metrics are used first. Interfaces with the same metric use load-balancing. Load-balanced member interfaces distribute more traffic out through those interfaces with higher weights.

Status

System

VPN

Services

Network

Interfaces

Wireless

DHCP and DNS

Hostnames

Static Routes

Diagnostics

Firewall

Client Isolation

Connection Check

QoS

Configure Diagnostics

[Load Balancing](#)

Statistics

Logout

Globals
Interfaces
Members
Policies
Rules
Notification

MWAN - Policies

Policies are profiles grouping one or more members controlling how MWAN distributes traffic
Member interfaces with lower metrics are used first
Member interfaces with the same metric will be load-balanced
Load-balanced member interfaces distribute more traffic out those with higher weights
Names may contain characters A-Z, a-z, 0-9, _ and no spaces
Names must be 17 characters or less
Policies may not share the same name as configured interfaces, members or rules

Name	Members assigned	Last resort				
modem_S1_only	modem_S1_m1_w3	unreachable (reject)	Up	Down	Edit	Delete
modem_S2_only	modem_S2_m1_w2	unreachable (reject)	Up	Down	Edit	Delete
balanced	modem_S1_m1_w3 modem_S2_m1_w2	unreachable (reject)	Up	Down	Edit	Delete
modem_S1_modem_S2	modem_S1_m1_w3 modem_S2_m2_w2	unreachable (reject)	Up	Down	Edit	Delete
modem_S2_modem_S1	modem_S1_m2_w3 modem_S2_m1_w2	unreachable (reject)	Up	Down	Edit	Delete

Add

Save & Apply
Save
Reset

41

MWAN policies page

6.1.3.7 MWAN Rules Configuration

Rules specify which traffic will use a particular MWAN policy based on IP address, port, or protocol. Rules are matched from top to bottom. Rules below a matching rule are ignored. Traffic not matching any rule is routed using the main routing table. Traffic destined for known (other than default) networks is handled by the main routing table. Traffic matching a rule, but with all WAN interfaces for that policy down, will be blackholed.

MWAN rules page

6.1.3.8 MWAN Notification Configuration

In the advanced configuration you may add a custom specific action on MWAN3 hotplug events, on interfaces for which MWAN3 is enabled.

This section allows to modify the content of “/etc/mwan3.user”. The file is also preserved during sysupgrade.

Notes:

- This file is interpreted as a shell script.
- The first line of the script must be “#!/bin/sh” without quotes.
- Lines beginning with # are comments and are not executed.
- There are three main environment variables that are passed to this script:
- \$ACTION Either “ifup” or “ifdown”
- \$INTERFACE Name of the interface which went up or down (e.g. “wan” or “wwan”)
- \$DEVICE Physical device name which interface went up or down (e.g. “eth0” or “wwan0”)

Status	Globals Interfaces Members Policies Rules Notification
System	MWAN - Notification
VPN	This section allows you to modify the content of "/etc/mwan3.user". The file is also preserved during sysupgrade.
Services	
Network	Notes: This file is interpreted as a shell script. The first line of the script must be "#!/bin/sh" without quotes. Lines beginning with # are comments and are not executed. Put your custom mwan3 action here, they will be executed with each netifd hotplug interface event on interfaces for which mwan3 is enabled.
Interfaces	
Wireless	
DHCP and DNS	
Hostnames	There are three main environment variables that are passed to this script.
Static Routes	
Diagnostics	\$ACTION * "ifup" Is called by netifd and mwan3track * "ifdown" Is called by netifd and mwan3track * "connected" Is only called by mwan3track if tracking was successful * "disconnected" Is only called by mwan3track if tracking has failed
Firewall	
Client Isolation	
Connection Check	\$INTERFACE Name of the interface which went up or down (e.g. "wan" or "wwan") \$DEVICE Physical device name which interface went up or down (e.g. "eth0" or "wwan0")
QoS	
Configure Diagnostics	
Load Balancing	
Statistics	
Logout	
	<pre>#!/bin/sh # # This file is interpreted as shell script. # Put your custom mwan3 action here, they will # be executed with each netifd hotplug interface event # on interfaces for which mwan3 is enabled. # # There are three main environment variables that are passed to this script. # # \$ACTION # <ifup> Is called by netifd and mwan3track # <ifdown> Is called by netifd and mwan3track # <connected> Is only called by mwan3track if tracking was successful # <disconnected> Is only called by mwan3track if tracking has failed # \$INTERFACE Name of the interface which went up or down (e.g. "wan" or "wwan") # \$DEVICE Physical device name which interface went up or down (e.g. "eth0" or "wwan0")</pre>
	<input type="button" value="Submit"/> <input type="button" value="Reset"/>

MWAN notification configuration

6.1.4 LACP / Bonding

Getting better overall bandwidth and failsave connections by using of Link Aggregation Control Protocol (LACP).

Combining multiple Gigabit Ethernet interfaces into a single logical bonding interface results in increased overall bandwidth between connected devices.

For detailed information about bonding interface configuration parameter please refer to [Linux Kernel documentation](#).

6.1.4.1 LACP configuration example

Following example gives a step-by-step instructions of configuration and testing of LACP with two Gigabit Ethernet devices.

Important

Please use a different interface for communication with the user interface than the one you want to use for LACP.

6.1.4.1.1 Create LACP interface

First of all a logical bonding interface should be created. This can be done by using of UI page (Network → Interfaces → Add new interface).

Add new interface...

Name	<input type="text" value="b1"/>
Protocol	<input type="text" value="Link Aggregation (Channel Bonding)"/>

6.1.4.1.2 Setup IP / Netmask

Next step is setting an ip address and a netmask for new created bonding interface (see tab → General Settings).

Interfaces » B1

General Settings | Advanced Settings | Firewall Settings

Status	<div style="border: 1px solid gray; padding: 5px; display: inline-block;"> Device: bonding-b1 RX: 0 B (0 Pkts.) TX: 0 B (0 Pkts.) </div>
Protocol	<input type="text" value="Link Aggregation (Channel Bonding)"/>
Bring up on boot	<input checked="" type="checkbox"/>
IPv4 address	<input type="text" value="192.168.100.182"/> <input checked="" type="checkbox"/> The local IPv4 address
IPv4 netmask	<input type="text" value="255.255.255.0"/> <input checked="" type="checkbox"/> The local IPv4 netmask

6.1.4.1.3 Setup bonding Policy / add slave Interfaces

Slave interfaces and bonding policy (IEEE 802.3ad = LACP) can be configured with tab Advanced Settings.

Interfaces » B1

General Settings | **Advanced Settings** | Firewall Settings

Use builtin IPv6-management	<input checked="" type="checkbox"/>	
Force link	<input type="checkbox"/>	<input type="checkbox"/> Set interface properties regardless of the link carrier (If set, carrier sense events do not invoke hotplug handlers).
Slave Interfaces	eth0	eth1 ▾
	<input type="checkbox"/> Specifies which slave interfaces should be attached to this bonding interface	
Bonding Policy	IEEE 802.3ad Dynamic link aggregation (▾)	
	<input type="checkbox"/> Specifies the mode to be used for this bonding interface	
Minimum Number of Links	0	
	<input type="checkbox"/> Specifies the minimum number of links that must be active before asserting carrier	
System Priority	65535	
	<input type="checkbox"/> Specifies the system priority	
MAC Address For The Actor		
	<input type="checkbox"/> Specifies the mac-address for the actor in protocol packet exchanges (LACPDU). If empty, masters' mac address defaults to system default	
Aggregation Selection Logic	Aggregator: All slaves down or has no sla ▾	
	<input type="checkbox"/> Specifies the aggregation selection logic to use	
LACPDU Packets	Every 30 seconds (slow, 0) ▾	
	<input type="checkbox"/> Specifies the rate in which the link partner will be asked to transmit LACPDU packets	
Drop Duplicate Frames	Yes ▾	
	<input type="checkbox"/> Specifies that duplicate frames (received on inactive ports) should be dropped or delivered	
Link Monitoring	Off ▾	
	<input type="checkbox"/> Method of link monitoring	

Dismiss
Save

6.1.4.1.4 Setup Firewall

If needed, firewall configuration can be done with tab `Firewall Settings`.

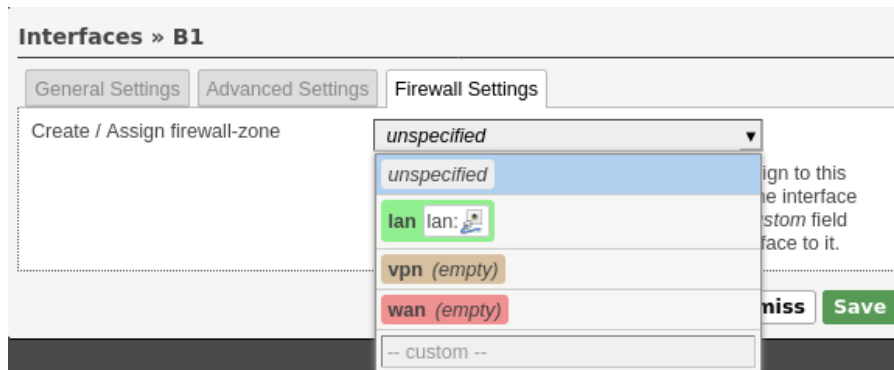

6.1.4.1.5 Check interface Status

After applying new configuration settings, bonding interface bonding-b1 should be up and running.

B1 bonding-b1	Protocol: Link Aggregation (Channel Bonding) Uptime: 0h 0m 31s MAC: 00:00:5B:03:B4:F8 RX: 29.20 KB (259 Pkts.) TX: 145.13 KB (288 Pkts.) IPv4: 192.168.100.182/24
-----------------------------	--

Interface status can also be verified by using of debug console.

```

root@LACP_TEST:~# cat /proc/net/bonding/bonding-b1
Ethernet Channel Bonding Driver: v3.7.1 (April 27, 2011)

Bonding Mode: IEEE 802.3ad Dynamic link aggregation
Transmit Hash Policy: layer2 (0)
MII Status: up
MII Polling Interval (ms): 100
Up Delay (ms): 0
Down Delay (ms): 0

802.3ad info
LACP rate: slow
Min links: 0
Aggregator selection policy (ad_select): stable
System priority: 65535
System MAC address: 00:00:5b:03:b4:f8
Active Aggregator Info:
  Aggregator ID: 2
  Number of ports: 2
  Actor Key: 9
  Partner Key: 1
  Partner Mac Address: 44:a5:6e:43:5d:70

Slave Interface: eth0
MII Status: up
Speed: 1000 Mbps
Duplex: full
Link Failure Count: 1
Permanent HW addr: 00:00:5b:03:b4:f8
Slave queue ID: 0
Aggregator ID: 2
Actor Churn State: monitoring
Partner Churn State: monitoring
Actor Churned Count: 1
Partner Churned Count: 1
details actor lacp pdu:
  system priority: 65535

```

```
system mac address: 00:00:5b:03:b4:f8
port key: 9
port priority: 255
port number: 1
port state: 61
details partner lacp pdu:
system priority: 32768
system mac address: 44:a5:6e:43:5d:70
oper key: 1
port priority: 128
port number: 2
port state: 63

Slave Interface: eth1
MII Status: up
Speed: 1000 Mbps
Duplex: full
Link Failure Count: 1
Permanent HW addr: 00:00:5b:03:b4:f9
Slave queue ID: 0
Aggregator ID: 2
Actor Churn State: monitoring
Partner Churn State: monitoring
Actor Churned Count: 0
Partner Churned Count: 1
details actor lacp pdu:
system priority: 65535
system mac address: 00:00:5b:03:b4:f8
port key: 9
port priority: 255
port number: 2
port state: 61
details partner lacp pdu:
system priority: 32768
system mac address: 44:a5:6e:43:5d:70
oper key: 1
port priority: 128
port number: 1
port state: 63
root@LACP_TEST:~#
```

6.1.4.2 LACP testing example

After bonding interface is configured and running, additional hardware is needed for verification of its functionality.

One of the most common bonding usage scenarios is a improvement of bandwidth and reliability between Server and Client's.

6.1.4.2.1 Test Setup

To have a practical setup a managed Switch with LACP support, our previously configured LACP_TEST device and also two client PCs with 1 Gigabit Ethernet interface are needed.

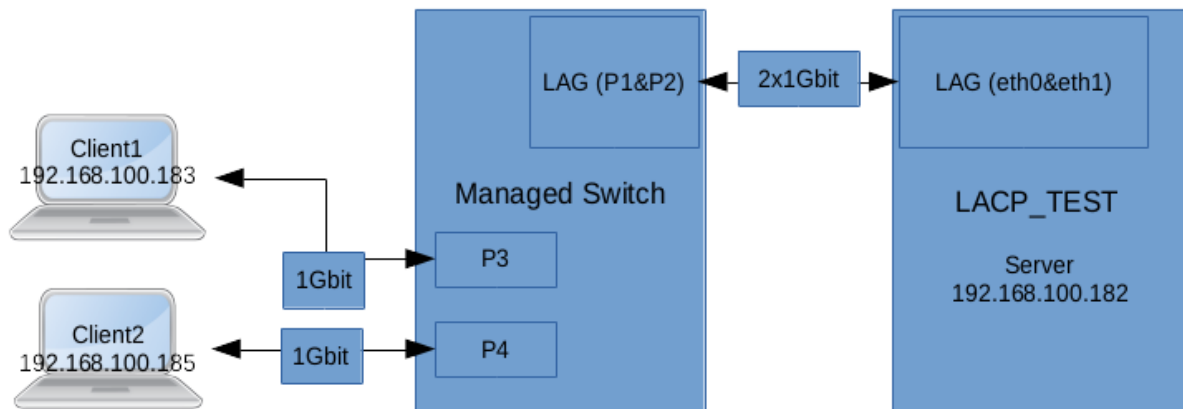

6.1.4.2.2 Test bonding bandwidth improvement

Without using of logical bonding interface maximal available bandwidth between switch and `LACP_TEST` device would be 1 Gbit, from a purely theoretical point of view. So the client PC's which are connected to switch would share this bandwidth and get not more than 500Mbits each. As we configured two 1 Gigabit Ethernet devices to one logical bonding interface the maximal bandwidth should be 2 Gbit. Each Client should be able to communicate with Server with maximal bandwidth of 1000Mbits.

In practical terms, the theoretical possible bandwidth cannot be reached! The maximal bandwidth would be round about 50-60% more than without bonding, so not 100%!

As a Measurement tool `iperf` is used. `LACP_TEST` device have `iperf` server instance running. Both client PC's communicating with the `iperf` server instance on `LACP_TEST` device at the same time. During the test we see both slaves of `LACP_TEST` bonding interface running. Each client communicates with the servers `iperf` instance over one of the both slave interfaces with about 800Mbits bandwidth.

6.1.4.2.3 Test bonding reliability improvement

In case Switch<->Server connection run without LACP, any communication errors will result in broken client connection. Due to reliability improvements of bonding implementation, communication between clients and server works also if one of the both LACP slaves goes down. This scenario can be easily verified by disconnecting one of the two bonding slaves e.g. `eth0`.

6.1.5 Global DHCP and DNS Settings

Be sure you understand DHCP and DNS services before changing any configurations. Under normal circumstances, keeping the factory default setting should be sufficient.

The CyBox GW uses a DNS, TFTP and DHCP server. It is intended to provide coupled DNS and DHCP service to a LAN. This service accepts DNS queries and either answers them from a small, local, cache or forwards them to a real, recursive DNS server. See Chapter DHCP server [6.1.1.1 DHCP Server per Interface](#).

The DHCP server supports static address assignments and multiple networks. It automatically sends a sensible default set of DHCP options, and can be configured to send any desired set of DHCP options, including vendor-encapsulated options. It includes a secure, read-only, TFTP server to allow net/PXE boot of DHCP hosts and also supports BOOTP.

Status	DHCP and DNS
System	Dnsmasq is a combined <u>DHCP-Server</u> and <u>DNS-Forwarder</u> for <u>NAT</u> firewalls
VPN	
Services	Server Settings
Network	<div style="border: 1px solid #ccc; padding: 2px; margin-bottom: 5px;"> General Settings Resolve and Hosts Files TFTP Settings Advanced Settings Static Leases </div>
Interfaces	Domain required <input checked="" type="checkbox"/> Don't forward <u>DNS-Requests</u> without <u>DNS-Name</u>
Wireless	
DHCP and DNS	Authoritative <input checked="" type="checkbox"/> This is the only <u>DHCP</u> in the local network
Hostnames	Local server <input type="text" value="/lan/"/> Local domain specification. Names matching this domain are never forwarded and are resolved from DHCP or hosts files only
Static Routes	Local domain <input type="text" value="lan"/> Local domain suffix appended to DHCP names and hosts file entries
Diagnostics	Log queries <input type="checkbox"/> Write received DNS requests to syslog
Firewall	DNS forwardings <input type="text" value="/example.org/10.1.2.3"/> + List of <u>DNS</u> servers to forward requests to
Client Isolation	Rebind protection <input checked="" type="checkbox"/> Discard upstream RFC1918 responses
Connection Check	Allow localhost <input checked="" type="checkbox"/> Allow upstream responses in the 127.0.0.0/8 range, e.g. for RBL services
QoS	Domain whitelist <input type="text" value="ihost.netflix.com"/> + List of domains to allow RFC1918 responses for
Configure Diagnostics	Local Service Only <input checked="" type="checkbox"/> Limit DNS service to subnets interfaces on which we are serving DNS.
Load Balancing	Non-wildcard <input checked="" type="checkbox"/> Bind dynamically to interfaces rather than wildcard address (recommended as linux default)
Statistics	Listen Interfaces <input type="text"/> + Limit listening to these interfaces, and loopback.
Logout	Exclude interfaces <input type="text"/> + Prevent listening on these interfaces.
	<input type="button" value="Save & Apply"/> <input type="button" value="Save"/> <input type="button" value="Reset"/>

DHCP And DNS Configuration Screen

6.1.6 Firewall

Be sure you understand zone-based firewalls before changing the firewall configurations.

The CyBox GW has a built-in stateful firewall mapping interfaces into Zones that are used to describe default rules for a given interface, forwarding rules between interfaces, and extra rules that are not covered by the first two.

The first rule that matches is executed, often leading to another rule-chain until a packet hits either ACCEPT or DROP/REJECT. Such an outcome is final, therefore the default rules take effect last, and the most specific rule takes effect first. Zones are also used to configure masquerading also known as NAT (network-address-translation) as well as port forwarding rules, which are more generally known as redirects.

Zones must always be mapped onto one or more Interfaces, which ultimately map onto physical devices; therefore zones cannot be used to specify networks (subnets), and the generated iptables rules operate on interfaces exclusively. The difference is that interfaces can be used to reach destinations not part of their own subnet, when their subnet contains another gateway. Usually however, forwarding is done between LAN and WAN interfaces, with the router serving as ‘edge’ gateway to the Internet. The default configuration of the Firewall provides for such a common setup.

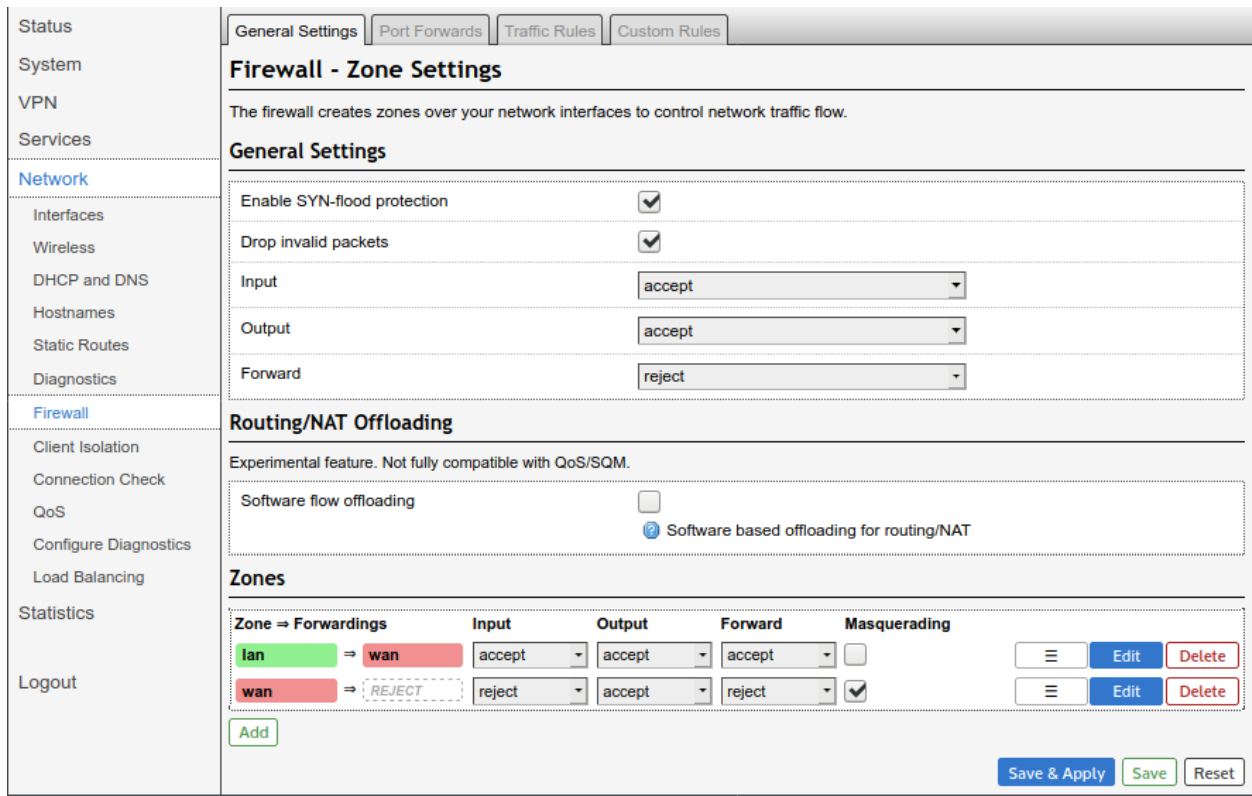

Firewall Zone Setting Screen

6.1.7 OpenVPN

Starting with firmware version 3.2 the Open Source VPN solution is included. The firmware before version 4.0 does not support a web frontend for OpenVPN configuration.

The OpenVPN program has many parameters to setup a connection. This chapter describes a basic Client OpenVPN tunnel configuration. In the next example the VPN tunnel connection is made through an already running LTE interface providing the Internet gateway.

6.1.7.1 Configuration file generation on Windows

OpenVPN for Windows can use an OpenVPN-GUI, which allows managing OpenVPN connections from a system tray applet. It can be used to generate a complete client configuration (zip file) including the .ovpn configuration file.

6.1.7.2 VPN interface setup – 3 methods

The VPN connection setup can be achieved by the three following methods.

6.1.7.2.1 Copy Ready-to-use configuration with SCP

This is the easiest way to configure a VPN connection. It is assumed that the server side has a configured network environment. The server administrator should create a valid client configuration package, including certificates, client keys and preferably a myclient.ovpn config file. The VPN connection is built on this configuration file (myclient.ovpn). This example uses four files that have to be static stored on the CyBox GW to allow the openvpn program to build up a connection without user interaction. If the 'auth-user-pass' option is given to openvpn without a parameter, the connection setup is interrupted and will ask for a username and password. To make this run automatically a two-line file with username (in first line) and password (in second line) has to be provided. All four files, the 'auth_user_pass', the 'pfelt1-udp-vpnuser_fg.p12', the user key file 'pfelt1-udp-vpnuser_fg-tls.key' and the 'myclient.ovpn' config file have to be copied from host system via 'scp' command to permanent storage located in '/etc/openvpn/' directory. Ensure that all files in '/etc/openvpn/' have file permission 600 (cd /etc/openvpn; chmod 600 *).

The 'myclient.ovpn' configuration is:

```
dev tun
persist-tun
persist-key
cipher AES-256-CBC
auth SHA1
tls-client
client
resolv-retry infinite
remote 166.93.10.174 1194 udp
lport 0
verify-x509-name "VPN Server Cert" name
auth-user-pass auth\_user\_pass
pkcs12 pfelt1-udp-vpnuser\_fg.p12
tls-auth pfelt1-udp-vpnuser\_fg-tls.key 1
ns-cert-type server
comp-lzo
```

6.1.7.2.2 Upload configuration, certs, key-files with web interface

The second method is quite the same as the first. A modified 'myclient.ovpn' file is used. The difference is, that the certificate, the key files and the password files are uploaded from web interface. The default web interface upload directory is /etc/luci-uploads/ and the uploaded file is appended with service type and interface name e.g.:

/etc/luci-uploads/cbid.openvpn.my_vpn.myclient.ovpn

As a first step add your new VPN configuration using a predefinition.

- 1 . New VPN configuration using a predefinition:

Edit your config.ovpn file and make sure that all certificates, key-files, user-name-pass files have the correct path including your config name, here 'my_vpn'.

The prepared 'myclient.ovpn' configuration looks like and is ready for upload:

(uploaded to /etc/luci-uploads/cbid.openvpn.my_vpn.myclient.ovpn)

```
dev tun
persist-tun
persist-key
cipher AES-256-CBC
auth SHA1
tls-client
client
resolv-retry infinite
remote 166.93.10.174 1194 udp
lport 0
verify-x509-name "VPN Server Cert" name
auth-user-pass
/etc/luci-uploads/cbid.openvpn.my\_vpn.auth\_user\_pass
pkcs12
/etc/luci-uploads/cbid.openvpn.my\_vpn.pfelt1-udp-vpnuser\_fg.p12
tls-auth
/etc/luci-uploads/cbid.openvpn.my\_vpn.pfelt1-udp-vpnuser\_fg-tls.key
1
ns-cert-type server
comp-lzo
```

6.1.7.2.3 Manual configuration with web interface

The third method does not use a preconfigured .ovpn file. You will have to enter each single parameter in the web interface. As the service is started, all given parameter are passed to the 'openvpn' program. This method may be useful for fast switching of parameters for server and client.

6.1.7.3 VPN host configuration (on console)

After the VPN client part configuration has been done, it's time to configure the rest of the system and start a first connection. This configuration can be done at console (via SSH) with 'uci' commands.

The openvpn program execution on the CyBox GW is managed with the '/etc/init.d/openvpn' script.

The following configuration is done at the command prompt:

Create the VPN interface: (if not running server-bridge)

```
uci set network.vpn0=interface
uci set network.vpn0.ifname=tun0
uci set network.vpn0.proto=none
uci set network.vpn0.auto=1
```

Allow inbound VPN traffic:

```
uci add firewall rule
uci set firewall.@rule[-1].name=Allow-OpenVPN-Inbound
uci set firewall.@rule[-1].target=ACCEPT
uci set firewall.@rule[-1].src=*
uci set firewall.@rule[-1].proto=udp
uci set
`firewall.@rule[-1].dest\_port=1194 <mailto:firewall.@rule[-1].dest\_port=1194>`__
```

Allow OpenVPN tunnel utilization: (not needed when bridging using tap)

```
uci set firewall.@zone[-1].input=REJECT
uci set firewall.@zone[-1].forward=REJECT
uci set firewall.@zone[-1].output=ACCEPT
uci set
`firewall.@zone[-1].network=vpn0 <mailto:firewall.@zone[-1].network=vpn0>`__
uci set firewall.@zone[-1].masq=1
uci set firewall.@zone[-1].mtu\_fix=1
uci add firewall forwarding
uci set firewall.@forwarding[-1].src='lan'
uci set firewall.@forwarding[-1].dest='vpn'
```

Commit the changes:

```
uci commit network
/etc/init.d/network reload
uci commit firewall
/etc/init.d/firewall reload
```

Enable the start flag and setup configuration file:

```
echo > /etc/config/openvpn
uci set openvpn.vpn=openvpn
uci set openvpn.vpn.enabled=1
uci set openvpn.vpn.config='/etc/openvpn/myclient.ovpn'
uci commit openvpn
```

Finally do a first test and start manually the openvpn connection:

```
/etc/init.d/openvpn start
```

Use the 'logread' command to watch the connection progress.

```
Nov 26 15:59:05 CyBoxAP daemon.notice openvpn(vpn)[8040]: OpenVPN 2.3.4
powerpc-openwrt-linux-gnu [SSL (OpenSSL)] [LZO] [EPOLL] [MH] [IPv6]
built on Nov 12 2015

Nov 26 15:59:05 CyBoxAP daemon.notice openvpn(vpn)[8040]: library
versions: OpenSSL 1.0.1i 6 Aug 2014, LZO 2.08

Nov 26 15:59:06 CyBoxAP daemon.notice openvpn(vpn)[8040]: Control
Channel Authentication: using 'pfeltl-udp-vpnuser\_fg-tls.key' as a
OpenVPN static key file

Nov 26 15:59:06 CyBoxAP daemon.notice openvpn(vpn)[8040]: UDPv4 link
local (bound): [undef]

Nov 26 15:59:06 CyBoxAP daemon.notice openvpn(vpn)[8040]: UDPv4 link
remote: [AF\_INET] 166.93.10.174:1194

Nov 26 15:59:06 CyBoxAP daemon.warn openvpn(vpn)[8040]: WARNING: this
configuration may cache passwords in memory -- use the auth-nocache
option to prevent this

Nov 26 15:59:08 CyBoxAP daemon.notice openvpn(vpn)[8040]: [VPN Server
Cert] Peer Connection Initiated with [AF\_INET] 166.93.10.174:1194

Nov 26 15:59:11 CyBoxAP daemon.notice openvpn(vpn)[8040]: TUN/TAP device
tun0 opened

Nov 26 15:59:11 CyBoxAP daemon.notice openvpn(vpn)[8040]: do\_ifconfig,
tt->ipv6=0, tt->did\_ifconfig\_ipv6\_setup=0
```

```

Nov 26 15:59:11 CyBoxAP daemon.notice openvpn(vpn)[8040]: /usr/sbin/ip
link set dev tun0 up mtu 1500

Nov 26 15:59:11 CyBoxAP daemon.notice openvpn(vpn)[8040]: /usr/sbin/ip
addr add dev tun0 local 192.168.20.6 peer 192.168.20.5

Nov 26 15:59:11 CyBoxAP daemon.notice netifd: Interface 'vpn0' is
enabled

Nov 26 15:59:11 CyBoxAP daemon.notice netifd: Network device 'tun0' link
is up

Nov 26 15:59:11 CyBoxAP daemon.notice netifd: Interface 'vpn0' has link
connectivity

Nov 26 15:59:11 CyBoxAP daemon.notice netifd: Interface 'vpn0' is
setting up now

Nov 26 15:59:11 CyBoxAP daemon.notice netifd: Interface 'vpn0' is now up

Nov 26 15:59:11 CyBoxAP daemon.notice openvpn(vpn)[8040]: Initialization
Sequence Completed

Nov 26 15:59:11 CyBoxAP user.notice firewall: Reloading firewall due to
ifup of vpn0 (tun0)

```

6.1.8 QoS

In the following example, a networking interface LAN or WLAN is prepared to use the Quality of Service function (QoS). The CyBox GW implements a QoS function with scripts to configure traffic control ('tc' command), which reduces throughput at a selected interface. To see the effect, a performance test can be started with the built-in 'iperf' program to measure the throughput.

- Select **Network** → **QoS**
- The default 'Interface' WAN is not activated and can be deleted.
 - In box Interfaces enter an existing interface name e.g. 'lan' an click button Add
 - Enter 1024 in the Download speed (kbit/s) field
 - Enter 1024 in the Upload speed (kbit/s) field
 - Activate checkbox Enable
 - Click **Save && Apply**

Do an 'iperf' performance test. The throughput should be about 10 Mbits/s. If a WLAN interface is bridged with the LAN port, the traffic control can even work on a single part of the bridge. To reduce the wireless traffic only, a new interface label must be added to **Network** → **Interfaces** menu e.g. WLAN. Then the new interface label has to be used in the QoS menu.

6.2 Modem

The **Modem Connection 3G/4G/5G** web page provides status information about a selected modem interface. The information is updated cyclically (about every 10 seconds). This page is divided into four sections, where the first section shows the connection status to the provider and the SIM card data. In the second section static modem parameters are displayed, such as type and firmware version.

The third section shows the current signal strengths as bar graphs. At the end of the page the output of a QMI command function is provided as text. Several QMI command functions can be configured, but only one is displayed at a time.

Modem Monitor

The screenshot displays the 'Modem Monitor' page for 'Modem in Slot 4'. It is divided into several sections:

- Connection Information:** Shows a 100% signal strength bar graph, operator 'vodafone.de (26202)', SIM status 'connected', connection status '0d, 00:02:12 | 2.6 KiB | 3.1 KiB', technology 'LTE + 5G-NonStandalone: EUTRAN-BAND20 + NR5G_BAND78', initial bearer 'web.vodafone.de, lpx4', registration 'home', and services 'WCDMA:none LTE:available 5G SA:none 5G NSA available:yes'.
- Modem Information:** Lists type 'SIMCom SIM8202G-M2', firmware revision 'MPSS.HI.2.5-01106-SDX35_CPEALL_PACK-1.486794.2.497576.2.1 [May 17 2022 07:00:00]', current modes 'allowed: 2g, 3g, 4g, 5g; preferred: 5g', IMEI '864284040291853', communication port 'mhi_0306_01.04.00_pipe_32 (at)', plugin 'simtech', and module temperature '36°C'.
- Signal Information:** Displays various signal strength metrics with bar graphs:
 - RSSI (Received Signal Strength Indicator): -32 dBm | Very good
 - SINR 4G (Signal to Interference plus Noise Ratio): 9.0 dB | Mid cell
 - RSRQ 4G (Reference Signal Received Quality): -8 dB | Excellent
 - RSRP 4G (Reference Signal Receive Power): -77 dBm | Very good
 - RSRQ 5G (Reference Signal Received Quality): -12 dB | Good
 - RSRP 5G (Reference Signal Receive Power): -109 dBm | Very weak
 - SNR 5G (Signal to Noise Ratio): 13.5 dB | Good
- System Info:** Shows the output of a QMI command:



```
[/dev/cdc_wdm_54 0] Successfully got system info:
WCDMA service:
  Status: 'none'
  True Status: 'none'
  Preferred data path: 'no'
LTE service:
  Status: 'available'
  True Status: 'available'
  Preferred data path: 'no'
  Domain: 'cs-ps'
  Service capability: 'cs-ps'
  Roaming status: 'off'
  Forbidden: 'no'
  Cell ID: '15537666'
  MCC: '262'
  MNC: '02'
  Tracking Area Code: '46150'
```

6.2.1 Modem Configuration

Use the **Modem** → **Modem Connection 3G/4G/5G** → **Configuration** tab to enter the configuration section.

Only one modem interface can be displayed on the monitor page. After a configuration `factory reset` the first modem found in the system is used. Only network modem interfaces can be selected.

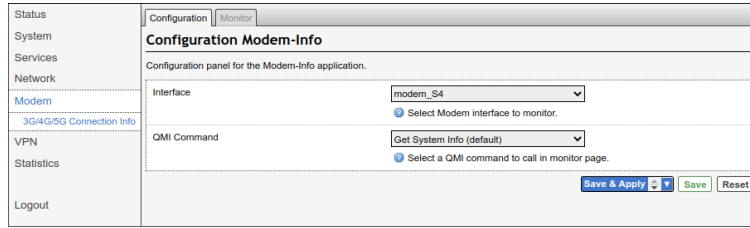
Modem Interface Configuration



Modem Interface Select

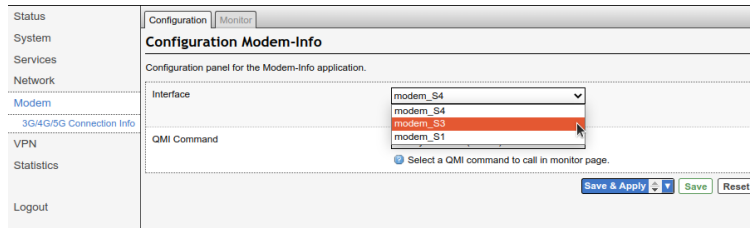

The call of the QMI function, which can be seen on the Monitor page, is also selected on the configuration page. With these QMI commands special connection parameters like TAC, LAC, Cell ID, rx/tx data-rates etc. can be read out. For detailed information about these QMI Command functions please refer to <https://www.freedesktop.org/software/libqmi/man/latest/qmicli.1.html>.

QMI Command Select

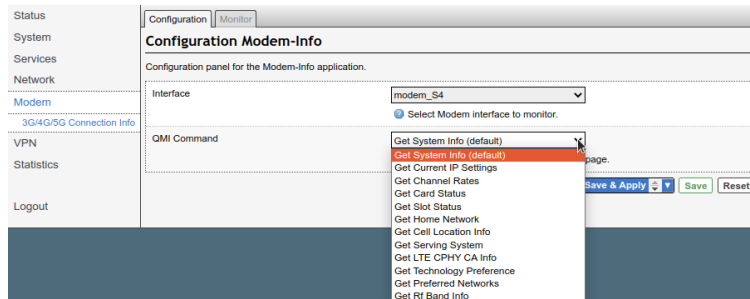

6.2.2 Modem Monitor

Use the Modem → Modem Connection 3G/4G/5G → Monitor tab to enter the monitoring section.

6.2.2.1 Connection Information

Modem Connection Section

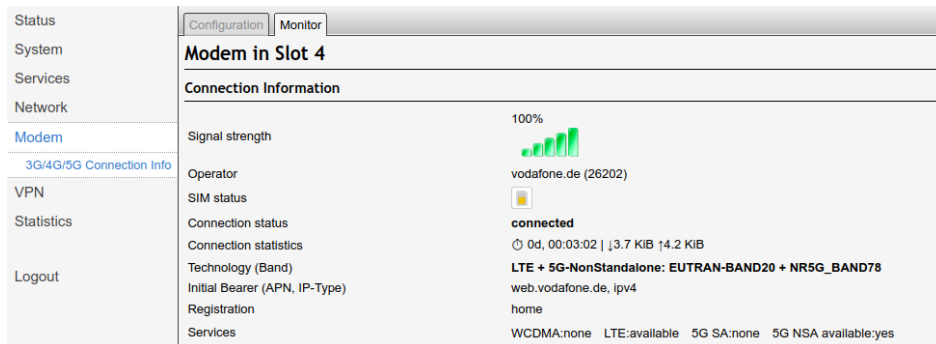

The signal strength is shown here in percent as an increasing bar graph. The basis for the display is the measured **RSSI** value. The display is always shown, even if no provider is connected.

If the connection was successful, the provider and the *mobile country codes (MCC)* as well as *mobile network codes (MNC)* are displayed in brackets in the operator line.

In the connection status line shows the individual phases of the connection establishment such as **searching**, **registered**, **connected**, ... but also a possible error message such as for example: **SIM missing**.

The connection statistics shows the duration of the connection and the amount of data for download and upload.

In the technology line the the 3G/4G/5G network registration mode and the occupied frequency bands are displayed. The type of network registration can also change within the **connected** phase without the connection being interrupted. e.g. **LTE+5GNSA => LTE => LTE+5GNSA**.

The next two lines show the APN used, the IP type and the registration mode (here: home).

The last line provides information about the registered cell and the services available in it, such as **WCDMA, UMTS, LTE, 5G-SA and 5G-NSA**. The availability of a certain service does not mean, however, that this service mode is also registered. For example, a 5G connection will not be established without a corresponding SIM card contract.

To display the SIM card information, move the mouse cursor over the SIM card icon. The used SIM **card slot**, the corresponding **PIN** and **APN** are read from the current configuration for the selected modem interface. The **Status** of the SIM card is listed in last line, is normally **SIM Ready**, but may also indicate a card problem e.g. Card busy, PIN error, ...

Modem SIM Card Information

Connection Information	
Signal strength	51%
Operator	vodafone.de (26202)
SIM status	Slot: 1 PIN: 0000
Connection status	connected
Connection statistics	
Technology (Band)	LTE + 5G-NonStandalone: EU1
Initial Bearer (APN, IP-Type)	web.vodafone.de, ipv4
Registration mode	home

The **IMSI** number stands for International Mobile Subscriber Identity. That uniquely identifies every user of a cellular network. It is stored as a 64-bit field and is sent by the mobile device to the network.

The **ICCID** stands for Integrated Circuit Card Identification Number. It's a unique 18-22 digit code that includes a SIM card's country, home network, and identification number. Usually the ICCID is printed on the back of a SIM card, but sometimes it's included in the packaging materials instead.

If no SIM card is installed for a modem interface or if there is no configuration, the modem still returns the signal strength values.

Modem SIM Card Missing

Modem in Slot 3	
Connection Information	
Signal strength	38%
Operator	-
SIM status	
Connection status	sim-missing
Connection statistics	-
Technology (Band)	-
Initial Bearer (APN, IP-Type)	-
Registration	-
Services	WCDMA:none LTE:limited 5G SA:none 5G NSA available:no

6.2.2.2 Modem Information

The modem information section displays the type of modem and the active modem firmware version. The **Current Modes** line shows the connection technologies currently allowed and preferred in the modem.

The communication port, which is used to send AT-Commands to the modem, and the software plugin are defined by the ModemManager. The module temperature is e.g. read out by an AT-Command.

The **IMEI** (International Mobile Station Equipment Identity) is a 15-digit serial number that is used to uniquely identify each GSM or UMTS terminal worldwide.

Modem Static Information

Modem Information	
Type	SIMCom SIM8202G-M2
Firmware Revision	MPSS.HI.2.5-01106-SDX55_CPEALL_PACK-1.486794.2.497576.2 1 [May 17 2022 07:00:00]
Current Modes	allowed: 2g, 3g, 4g, 5g; preferred: 5g
IMEI	864284040291853
Communication port	mhi_0306_01.04.00_pipe_32 (at)
Plugin	simtech
Module temperature	37°C

6.2.2.3 Signal Information

Modem Signal Information

Signal Information	
RSSI (Received Signal Strength Indicator)	-52 dBm Very good
SINR 4G (Signal to Interference plus Noise Ratio)	9.0 dB Mid cell
RSRQ 4G (Reference Signal Received Quality)	-13 dB Good
RSRP 4G (Reference Signal Receive Power)	-77 dBm Very good
RSRQ 5G (Reference Signal Received Quality)	-12 dB Good
RSRP 5G (Reference Signal Receive Power)	-109 dBm Very weak
SNR 5G (Signal to Noise Ratio)	12.5 dB Mid cell

RSSI (Signal strength) The signal strength value indicates the level of the signal received by the modem. These values correspond to the RSSI (Received Signal Strength Indication) readings of the connection. The value is measured in [dBm]. RSSI is typically displayed in a range from -94 dBm (very weak) up to >74 dBm (very good).

SINR 4G (Signal Interference + Noise Ratio), is the ratio of the signal level to the noise level (or simply the signal-to-noise ratio). The SINR value is measured in [dB] and ranges from 0 very low (cell edge) to 21 and higher (excellent). It is quite simple: the higher the value, the better the signal quality. With SINR values below 0, the connection speed is very low (cell edge), as this means that the received signal contains more noise than the useful part, and there is also a probability of losing an LTE connection.

RSRQ 4G/5G (Reference Signal Received Quality) The RSRQ is a calculated ratio value that results from the value for RSRP and the RSSI. It is enormously important for assessing the reception quality of a 5G or LTE connection. The value is measured in *[dBm]*. RSRQ is typically displayed in a range from -19 dB (cell edge) up to -9 dB (excellent).

RSRP 4G/5G (Reference Signal Received Power) The average power of the received pilot signals (Reference Signal) or the level of the received signal from the Base Station. The RSRP value is measured in *[dBm]*. RSRP is typically displayed in a range from -100 dB (very weak) up to >79 dB and higher (very good).

SNR 5G (Signal to Noise Ratio) It is the ratio of signal power to that of all other electrical signals in the area, known as the noise level. Noise is measured by the Root-Mean-Square (RMS) value of the fluctuations over time. This ratio is expressed in decibels *[dB]*. With SNR value is only shown for 5G environments and ranges from <=15 dB (cell edge) up to >=40 dB (excellent).

6.2.2.4 QMI Command Information

QMI Command Output

```

System Info
-----
[/dev/cdc_wdm_54_0] Successfully got system info:
WCDMA service:
  Status: 'none'
  True Status: 'none'
  Preferred data path: 'no'
LTE service:
  Status: 'available'
  True Status: 'available'
  Preferred data path: 'no'
  Domain: 'cs-ps'
  Service capability: 'cs-ps'
  Roaming status: 'off'
  Forbidden: 'no'
  Cell ID: '15537684'
  MCC: '262'
  MNC: '02'
  Tracking Area Code: '46150'
  Voice support: 'yes'
  IMS voice support: 'yes'
  eMBMS coverage info support: 'no'
  eMBMS coverage info trace ID: '65535'
  Cell access: 'all-calls'
  Registration restriction: 'unrestricted'
  Registration domain: 'not-applicable'
  5G NSA Available: 'yes'
  DCNR Restriction: 'no'
5G SA service:
  Status: 'none'
  True Status: 'none'
  Preferred data path: 'no'
SIM reject info: 'available'
  
```

This text area shows the QMI function call returned output. For detailed information about qmilib functions please refer to <https://www.freedesktop.org/software/libqmi/man/latest/qmicli.1.html>.

6.3 System

6.3.1 System Properties

The **System Properties** are managed in the tab `System` → `System`. These menus handle logging options, NTP time synchronisation and the appearance, language of the web interface. In the `General Settings` tab the operating system time, that is always stored as UTC time can be synchronized with current browser time. Note that the shell console time, of a serial or a remote SSH connection, is always reported as UTC time stamp.

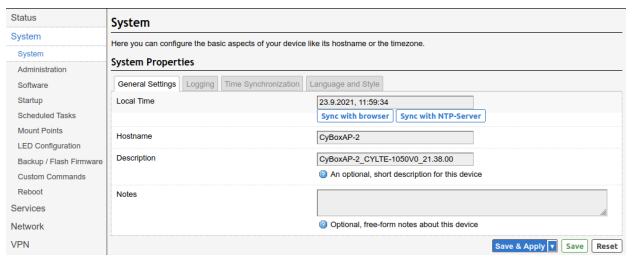

6.3.2 Configuration Backups

Configuration is managed in the tab `System` → `Backup/Flash Firmware`.

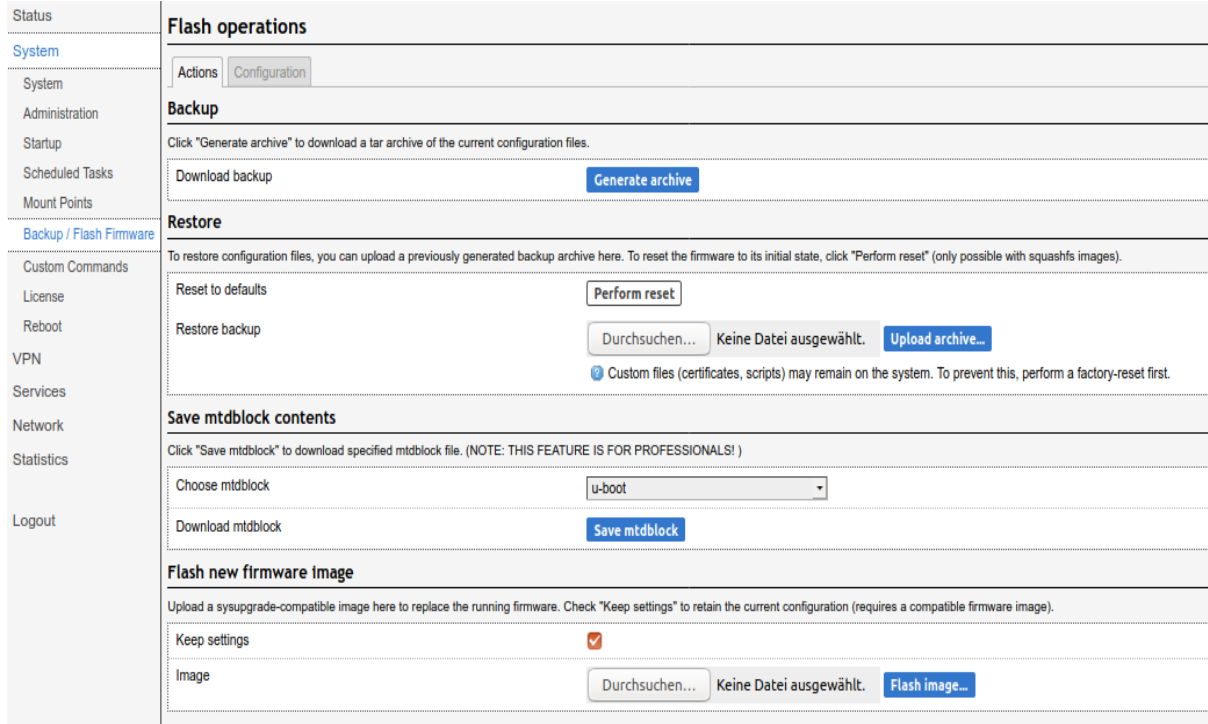

Configuration Backup Settings

a. Restore factory settings

Perform reset restores factory settings and performs a reboot.

b. Export configuration

Use the Generate archive button to export a configuration backup.

The generated configuration tar archive is not hardware-specific and may be distributed to other access points, as long as they share the same model and the same firmware version.

Note: Configuration archives are not compatible between firmware revisions 4.x and 17.xx.yy.

With the Upload archive... button you can restore a previously saved configuration. After restoring a configuration, the access point will reboot.

c. Import configuration

Before restoring a configuration archive, make sure that the factory settings have been restored in order to avoid any conflict between your old and new configuration. The configuration file must be named according to the pattern backup-*.tar.gz and can then be uploaded in the Restore backup field.

6.3.3 Firmware Upgrade

The procedure to update the device firmware with a new image is shown below.



Firmware Update Settings

Firmware Updates are provided as binary images with the extension .itb and will be uploaded from the host computer. Keep settings should always be **cleared** to ensure not to mixup old and new config switches. The uploaded image has a MD5 checksum that must be confirmed in the following dialog.

WARNING: Do NOT POWER OFF the access point while upgrading/restoring firmware to flash. Remember that if ``Keep settings`` checkbox is cleared, the device will revert to its network default address after restart.

6.3.4 Reboot

The device can be rebooted on the `System` → `Reboot` tab.

6.3.5 Reset Button

The operations which can be done with the reset button are: reboot, triggering the emergency mode, restoring factory settings.

a. Restore factory settings

After booting, a factory reset can be triggered by pressing the reset button with a pin for more than 5 seconds. The Fail LED will blink in green and after a few seconds the device will reboot with the default configuration.

A reboot can be triggered by pressing the reset button with a pin for less than 2 seconds.

6.3.6 Emergency Mode

Emergency mode should only be needed in case of system firmware upgrade or crash restore.

The CyBox AP family uses at least five partitions in flash memory. The first flash device contains the low level firmware U-Boot. The second flash device holds an emergency image of OpenWrt/Linux and the third device contains the standard image of OpenWrt/Linux. The fourth flash device contains a journaling flash file system partition with user configuration settings and a customer partition. Normally the standard OpenWrt/Linux image is loaded with U-Boot and checked with MD5 sum against errors. If checksums are valid the linux boots and access point service starts. User configuration parameters are loaded and applied from the JFFS partition.

In case of a damaged standard image (OpenWrt/Linux in third flash) U-Boot detects a MD5 checksum error and tries to start the emergency system image from second flash. While booting no user configuration settings are applied. The CyBox GW comes up with network default address 192.168.100.1 (user=root, password=root) and Wifi disabled. The Fail LED blinks orange (red and green on) and the web interface background is orange, as Figure indicates. All configuration settings are volatile. This system should only be used to Upgrade/Restore a working firmware image to second flash via `Backup / Flash Firmware` menu.

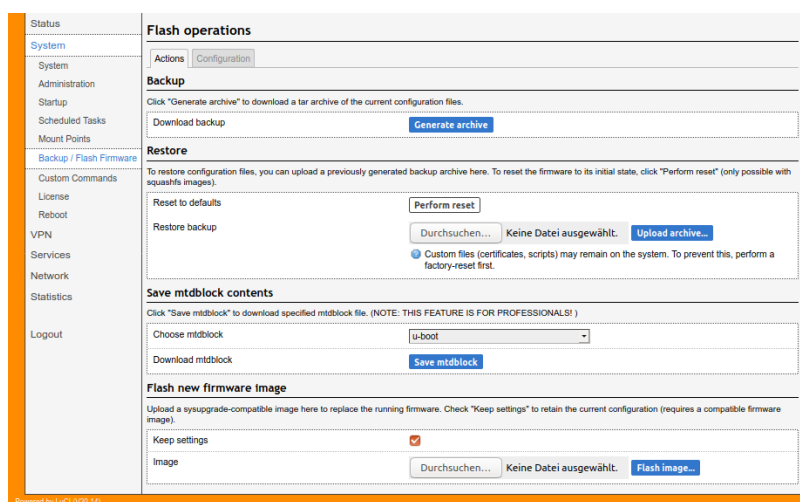

Emergency System Indication

Emergency mode can also be entered by holding the reset button pressed for 5 seconds at the beginning of the boot phase.

Note: Normally, the blue background indicates the standard mode and the orange background indicates emergency mode. But many web browsers keep the colours in cache, which means that the wrong colour can be displayed. To ensure that the correct one is shown, open a new window in private or incognito mode before consulting the web interface.

7 SNMP

7.1 SNMP Protocol Support

Firmware implementations before 2020 only have protocol support for version **v1** and **v2c**. Since 2020 the SNMP protocol **v3** is also included in every CyBox firmware. The **v1**, **v2c** protocol variants are present with factory default setup. In factory default setup only read access is permitted.

Status	SNMPD						
System	SNMPD is a master daemon/agent for SNMP, from the net-snmp project . This LuCI applet covers basic configuration options. See documentation for manual configuration.						
VPN							
Services	Protocol activation						
Customize	<table border="1"> <tr> <td>Enable v1 protocol</td> <td><input checked="" type="checkbox"/></td> </tr> <tr> <td>Enable v2c protocol</td> <td><input checked="" type="checkbox"/></td> </tr> <tr> <td>Enable v3 protocol</td> <td><input type="checkbox"/></td> </tr> </table>	Enable v1 protocol	<input checked="" type="checkbox"/>	Enable v2c protocol	<input checked="" type="checkbox"/>	Enable v3 protocol	<input type="checkbox"/>
Enable v1 protocol	<input checked="" type="checkbox"/>						
Enable v2c protocol	<input checked="" type="checkbox"/>						
Enable v3 protocol	<input type="checkbox"/>						
SNMPD							
SNMPD Edit							
SNMP-Trap							
GPS Info							
GPSD							
ICCP							
Softflowd							
Network	Agent settings						
Statistics	<p>The address the agent should listen on <input type="text" value="UDP:161"/></p> <p><small>Eg: UDP:161, or UDP:10.5.4.3:161 to only listen on a given interface</small></p>						
Logout	AgentX settings						
	<p>The address the agent should allow agentX connections to <input type="text" value="/var/run/agentx.sock"/></p> <p><small>This is only necessary if you have subagents using the agentX socket protocol. Note that agentX requires TCP transport</small></p>						
	Protocol V3 settings						
	<p>Create Protocol V3 User</p> <p><i>This section contains no values yet</i></p> <p><input type="text"/> <input type="button" value="Add"/></p>						
	com2sec security						
	PUBLIC						
	<table border="1"> <tr> <td>secname</td> <td><input type="text" value="ro"/></td> </tr> <tr> <td>source</td> <td><input type="text" value="default"/></td> </tr> <tr> <td>community</td> <td><input type="text" value="public"/></td> </tr> </table>	secname	<input type="text" value="ro"/>	source	<input type="text" value="default"/>	community	<input type="text" value="public"/>
secname	<input type="text" value="ro"/>						
source	<input type="text" value="default"/>						
community	<input type="text" value="public"/>						
	PRIVATE						

SNMPD factory default settings with protocol v1 and v2c enabled

7.2 SNMP V3 Protocol Support

Before any **v3** protocol access can be executed one or more V3 User Accounts have to be created. To add a new **v3** User Account, the name must be entered case sensitive. Later the WUI is showing the User Account name in upper case.

	Protocol V3 settings
	<p>Create Protocol V3 User</p> <p><i>This section contains no values yet</i></p> <p><input type="text" value="SHAAESUser"/> <input type="button" value="Add"/></p>

Add new v3 User Account

The new User Account can be created as read-only, or with read-write permission. The authentication protocol is either **MD5** or **SHA** (preferred). If a authentication protocol is selected the authentication passphrase must also be given. For data paket encryption select **DES** or **AES** (preferred) and also apply a passphrase. For demonstration use the same settings as in figure below to copy and paste them in examples.

Protocol V3 settings

Create Protocol V3 User Delete

SHAAESUSER

User Name	<input type="text" value="SHAAESUser"/>
User Access	<input type="text" value="Read-Write User"/>
Authentication Protocol	<input type="text" value="SHA"/>
Authentication Passphrase	<input type="text" value="sha_password"/>
Privacy Protocol	<input type="text" value="AES"/>
Privacy Passphrase	<input type="text" value="aes_passphrase"/>

Demo user account settings

The default protocols **v1** and **v2c** should be disabled, when using SNMP-V3 protocol.

Services	Protocol activation
Customize	Enable v1 protocol <input type="checkbox"/>
SNMPD	Enable v2c protocol <input type="checkbox"/>
SNMPD Edit	Enable v3 protocol <input checked="" type="checkbox"/>
SNMP-Trap	

Activate only SNMP-V3 protocol

After all new settings are entered press the **Save & Apply**. Then the SNMPD service will restarted automatically.

7.2.1 SNMP V3 Protocol Examples

Read access with **snmpget**: Get order identifier

The command:

```
snmpget -v 3 -n "" -u SHAAESUser -a SHA -A "sha_password" -x AES -X "aes_passphrase" -l authPriv 192.168.100.1 1.3.6.1.4.1.2021.8.1.2.100.101.1
```

Returns:

```
iso.3.6.1.4.1.2021.8.1.2.100.101.1 = STRING: "CYAPW-1057P0"
```

Read access with **snmpwalk**: Get firmware version

The command:

```
snmpwalk -v 3 -n "" -u SHAAESUser -a SHA -A "sha_password" -x AES -X "aes_passphrase" -l authPriv 192.168.100.1 1.3.6.1.4.1.2021.8.1.2.103
```

Returns:

```
iso.3.6.1.4.1.2021.8.1.2.103.1.1 = INTEGER: 1
iso.3.6.1.4.1.2021.8.1.2.103.2.1 = STRING: "firmware_version"
iso.3.6.1.4.1.2021.8.1.2.103.3.1 = STRING: "/usr/bin/eltec_version"
```

```
iso.3.6.1.4.1.2021.8.1.2.103.100.1 = INTEGER: 0
iso.3.6.1.4.1.2021.8.1.2.103.101.1 = STRING: "20.14"
iso.3.6.1.4.1.2021.8.1.2.103.102.1 = INTEGER: 0
iso.3.6.1.4.1.2021.8.1.2.103.103.1 = ""
```

Write access with **snmpset**: Set a new system hostname and reload system settings

Use the following sequence to set the new hostname:

```
snmpset -v 3 -n "" -u SHAAESUser -a SHA -A "sha_password" -x AES -X "aes_passphrase" -l authPriv
192.168.100.1 1.3.6.1.4.1.2021.8.1 s "uci set system.@system[0].hostname=Brutus"

iso.3.6.1.4.1.2021.8.1 = STRING: "uci set system.@system[0].hostname=Brutus"

snmpset -v 3 -n "" -u SHAAESUser -a SHA -A "sha_password" -x AES -X "aes_passphrase" -l authPriv
192.168.100.1 1.3.6.1.4.1.2021.8.1 s "uci commit system"

iso.3.6.1.4.1.2021.8.1 = STRING: "uci commit system"

snmpset -v 3 -n "" -u SHAAESUser -a SHA -A "sha_password" -x AES -X "aes_passphrase" -l authPriv
192.168.100.1 1.3.6.1.4.1.2021.8.1 s "service system reload"

iso.3.6.1.4.1.2021.8.1 = STRING: "service system reload"
```

The new system hostname can be checked on web Status page.

7.3 SNMP Basic Functions

The SNMP service is included in CyBox GW Starting with firmware Version 2.6. The service is enabled, if a valid configuration file `/etc/config/snmpd` is present and service startup is not disabled. On system start this configuration file is parsed and translated into a `snmpd.conf` file which is required by the SNMP daemon. The `snmpd.conf` is stored in `/var/run` and a symbolic link is available under `/etc/snmp`.

There is a basic web interface provided for SNMP private / public configuration under Services → SNMPD. The whole configuration file is quite large (~120KB) and can be modified on command line with UCI commands or by editing the configuration file with Services → SNMPD-Edit edit window. The current implementation is automatically generated from a build script.

The OpenWrt default configuration provides a set of standard MIB files with OID `.1.3.6.1.2.1` (`iso.org.dod.internet.mgmt.mib-2`). Westermo Eltec also provides an extension for the default configuration, using the UC DAVIS (University of California, Davis) MIB object (UCD-SNMP-MIB MIB document as `.1.3.6.1.4.1.2021`) to map many configuration settings with a wrapper shell for reading `/usr/sbin/get_snmp` and one for writing `/usr/sbin/set_snmp` single entries in the configuration files located under `/etc/config`. The `get_snmp` script provides also information about WLAN to SSID assignment, WLAN bitrates, signal quality, etc. Most of this information is gained via UCI commands for reading and writing system configuration settings.

`/etc/snmp/snmpd.conf` # Symlink to SNMPD config file (automatically created)

`/etc/config/snmpd` # OpenWrt configuration file

See Appendix 10 for a SNMP command OID overview.

7.4 SNMP Read and Write Authorizations

The CyBox GW runs a local SNMP daemon, which currently is configured for two access groups:

- By default, group “public” allows unrestricted read-only access
- Group “private” allows a single specified host to read and write. By default, “localhost” is specified i.e. only the local administrative user on CyBox GW is allowed for SNMP write operations.

This address can be changed by means of an UCI command. Assuming to be logged-in on a CyBox GW via SSH as administrative user, the following command would allow re-specifying the IP address of the “private” group:

```
root@CyBoxAP:~# uci set snmpd.private.source=<ccu>
root@CyBoxAP:~# uci commit snmpd
root@CyBoxAP:~# /etc/init.d/snmpd restart
```

Where <ccu> refers to the IP address (or hostname) of the remote host which is allowed to perform SNMP write operations. The keyword “default” instead of a specific address allows any hosts to access the SNMP demon.

Similarly, the address of the “public” group can be changed:

```
root@CyBoxAP:~# uci set snmpd.public.source=<ccu>
root@CyBoxAP:~# uci commit snmpd
root@CyBoxAP:~# /etc/init.d/snmpd restart
```

Note: Generally local UCI commands on the CyBox GW should be used for handling the configuration of the SNMP demon. Run `'uci show snmpd'` to view the current settings.

Alternatively, the public and private sources can be modified with the web interface in the field ‘com2sec security’ of the tab ‘Services’ → ‘SNMPD’.

com2sec security	
PUBLIC	
secname	ro
source	default
community	public
PRIVATE	
secname	rw
source	localhost
community	private

SNMPD change ‘com2sec security’ for write access

7.5 SNMP Commands

The CyBox GW SNMP demon supports the following commands:

- snmpget
- snmpset
- snmpstatus
- snmpstest
- snmptrap
- snmpwalk

A special case arises when snmpset writes to non-MIB extensions. In this case, there is an asymmetry between snmpget and snmpset with respect to OIDs. Reading (snmpget) requires the complete numeric identifier including the server-specific extension. Writing (snmpset) accepts only the “extEntry” trunk “iso.3.6.1.4.1.2021.8.1”, while the server-specific name of the object must be passed as first argument.

The assignment of names and OID numbers can be found by executing snmpwalk.

7.6 SNMP Read (snmpwalk and snmpget)

The following chapters describe the read and write access via console commands.

7.6.1 Reading System Information

```
boardname 1.3.6.1.4.1.2021.8.1.2.100
serial_number 1.3.6.1.4.1.2021.8.1.2.101
uboot_version 1.3.6.1.4.1.2021.8.1.2.102
firmware_version 1.3.6.1.4.1.2021.8.1.2.103
config_version 1.3.6.1.4.1.2021.8.1.2.104
uptime 1.3.6.1.4.1.2021.8.1.2.105
loadavg 1.3.6.1.4.1.2021.8.1.2.106
temperature 1.3.6.1.4.1.2021.8.1.2.107
uci_get 1.3.6.1.4.1.2021.8.1.2.108
custom1 1.3.6.1.4.1.2021.8.1.2.109
custom2 1.3.6.1.4.1.2021.8.1.2.110
custom3 1.3.6.1.4.1.2021.8.1.2.111
mpstat 1.3.6.1.4.1.2021.8.1.2.112
```

The command

```
snmpwalk -c public -v 2c 192.168.100.1 1.3.6.1.4.1.2021.8.1.2.100
```

will deliver

```
iso.3.6.1.4.1.2021.8.1.2.100.1.1 = INTEGER: 1
iso.3.6.1.4.1.2021.8.1.2.100.2.1 = STRING: "boardname"
iso.3.6.1.4.1.2021.8.1.2.100.3.1 = STRING: "/bin/cat /tmp/sysinfo/eeprom/BOARDNAME"
iso.3.6.1.4.1.2021.8.1.2.100.100.1 = INTEGER: 0
iso.3.6.1.4.1.2021.8.1.2.100.101.1 = STRING: "CYAP.-V-W8IRQWWEUPX"
iso.3.6.1.4.1.2021.8.1.2.100.102.1 = INTEGER: 0
iso.3.6.1.4.1.2021.8.1.2.100.103.1 = ""
```

MIB name:

```
iso.3.6.1.4.1.2021.8.1.2.100.2.1 = STRING: "boardname"
```

Function executed on CyBox GW:

```
iso.3.6.1.4.1.2021.8.1.2.100.3.1 = STRING: "/bin/cat /var/BOARDNAME"
```

Error code from function call:

```
iso.3.6.1.4.1.2021.8.1.2.100.100.1 = INTEGER: 0
```

Return value from function call:

```
iso.3.6.1.4.1.2021.8.1.2.100.101.1 = STRING: "CYAP.-V-W8IRQWWEUPX"
```

7.6.2 Reading SNMP Object Information

The main problem to access a network device (WLAN or LAN) is that the listing order depends on the creation order made by user when the config file is being edited. The fact that network/interface naming is free to choose and that UCD MIB object names are static, makes it necessary to use predefined names like:

- network0, network1 ... network9
- wireless0, wireless1 ... wireless19

Note: A normal CyBox GW configuration consists of six wireless interfaces, but there are up to twenty interfaces possible, so snmpwalk will result in up to 80 percent of undefined (Empty UCI entry) values.

The following objects are available to determine the actual network/wireless ordering.

7.6.2.1 Readout current Network Device Order

The command

```
snmpwalk -c public -v 2c 192.168.100.1 1.3.6.1.4.1.2021.8.1.2.150
```

delivers

```
iso.3.6.1.4.1.2021.8.1.2.150.1.1 = INTEGER: 1
iso.3.6.1.4.1.2021.8.1.2.150.2.1 = STRING: "network_order"
iso.3.6.1.4.1.2021.8.1.2.150.3.1 = STRING: "/etc/snmp/get_cyboxap network_order"
iso.3.6.1.4.1.2021.8.1.2.150.100.1 = INTEGER: 0
iso.3.6.1.4.1.2021.8.1.2.150.101.1 = STRING: "loopback=lo" **<--- network0**
iso.3.6.1.4.1.2021.8.1.2.150.101.2 = STRING: "lan=eth0" **<--- network1**
iso.3.6.1.4.1.2021.8.1.2.150.101.3 = STRING: "vlan007=eth0.7" **<--- network2**
iso.3.6.1.4.1.2021.8.1.2.150.101.4 = STRING: "vlan123=eth0.123" **<--- network3**
iso.3.6.1.4.1.2021.8.1.2.150.101.5 = STRING: "vlan500=eth0.500" **<--- network4**
iso.3.6.1.4.1.2021.8.1.2.150.101.6 = STRING: "cfg_net=eth0.999" **<--- network5**
iso.3.6.1.4.1.2021.8.1.2.150.102.1 = INTEGER: 0
iso.3.6.1.4.1.2021.8.1.2.150.103.1 = ""
```

Example:

IP address of LAN interface 'cfg_net' will be (network5 starts at 550):

```
network5.ipaddr 1.3.6.1.4.1.2021.8.1.2.552
```

The command

```
snmpget -c public -v 2c 192.168.100.1 1.3.6.1.4.1.2021.8.1.2.552.101.1
```

delivers

```
iso.3.6.1.4.1.2021.8.1.2.552.101.1 = STRING: "192.168.99.98"
```

7.6.2.2 Readout SSID / WIFI Interface Order

The following command shows the order of the Wifi interfaces.

```
snmpwalk -c public -v 2c 192.168.100.1 1.3.6.1.4.1.2021.8.1.2.151
iso.3.6.1.4.1.2021.8.1.2.151.1.1 = INTEGER: 1
iso.3.6.1.4.1.2021.8.1.2.151.2.1 = STRING: "ssid_order"
iso.3.6.1.4.1.2021.8.1.2.151.3.1 = STRING: "/etc/snmp/get_cyboxap ssid_order"
iso.3.6.1.4.1.2021.8.1.2.151.100.1 = INTEGER: 0
iso.3.6.1.4.1.2021.8.1.2.151.101.1 = STRING: "CyAP0_00486889_00486886_EST0" **<--- wireless0**
iso.3.6.1.4.1.2021.8.1.2.151.101.2 = STRING: "Guest_007" **<--- wireless1**
iso.3.6.1.4.1.2021.8.1.2.151.101.3 = STRING: "CyAP0_00486889_00486886_vlan007" **<--- wireless2**
iso.3.6.1.4.1.2021.8.1.2.151.101.4 = STRING: "CyAP0_00486889_00486886_vlan123**" <--- wireless3**
iso.3.6.1.4.1.2021.8.1.2.151.101.5 = STRING: "CyAP0_00486889_00486886_vlan500" **<--- wireless4**
iso.3.6.1.4.1.2021.8.1.2.151.101.6 = STRING: "CyAP0_00486889_00486886_cfg_net" **<--- wireless5**
```

```
iso.3.6.1.4.1.2021.8.1.2.151.101.7 = STRING: "Guest_123" **<--- wireless6**
iso.3.6.1.4.1.2021.8.1.2.151.101.8 = STRING: "VIP_500" **<--- wireless7**
iso.3.6.1.4.1.2021.8.1.2.151.102.1 = INTEGER: 0
iso.3.6.1.4.1.2021.8.1.2.151.103.1 = ""
```

7.6.2.3 Readout Network Device to SSID Assignment

The following command shows the order of the Wifi interfaces.

```
snmpwalk -c public -v 2c 192.168.100.1 1.3.6.1.4.1.2021.8.1.2.152
iso.3.6.1.4.1.2021.8.1.2.152.1.1 = INTEGER: 1
iso.3.6.1.4.1.2021.8.1.2.152.2.1 = STRING: "wlan_ssid"
iso.3.6.1.4.1.2021.8.1.2.152.3.1 = STRING: "/etc/snmp/get_cyboxap wlan_ssid"
iso.3.6.1.4.1.2021.8.1.2.152.100.1 = INTEGER: 0
iso.3.6.1.4.1.2021.8.1.2.152.101.1 = STRING: "wlan0 : \\\"CyAP0_00486889_00486886_EST0\\\""
iso.3.6.1.4.1.2021.8.1.2.152.101.2 = STRING: "wlan0-1 : \\\"CyAP0_00486889_00486886_vlan007\\\""
iso.3.6.1.4.1.2021.8.1.2.152.101.3 = STRING: "wlan0-2 : \\\"CyAP0_00486889_00486886_vlan123\\\""
iso.3.6.1.4.1.2021.8.1.2.152.101.4 = STRING: "wlan0-3 : \\\"CyAP0_00486889_00486886_vlan500\\\""
iso.3.6.1.4.1.2021.8.1.2.152.101.5 = STRING: "wlan0-4 : \\\"CyAP0_00486889_00486886_cfg_net\\\""
iso.3.6.1.4.1.2021.8.1.2.152.101.6 = STRING: "wlan1 : \\\"Guest_007\\\""
iso.3.6.1.4.1.2021.8.1.2.152.101.7 = STRING: "wlan1-1 : \\\"Guest_123\\\""
iso.3.6.1.4.1.2021.8.1.2.152.101.8 = STRING: "wlan1-2 : \\\"VIP_500\\\""
iso.3.6.1.4.1.2021.8.1.2.152.102.1 = INTEGER: 0
iso.3.6.1.4.1.2021.8.1.2.152.103.1 = ""
```

Note 1: This assignment may change every time a specific SSID is disabled or enabled and the wireless interface is restarted. The corresponding Linux WLAN device for a SSID is needed to readout current assoclist, bitrates and signal quality values.

Note 2: The order/assignment functions 150, 151 and 152 should not be polled in an application, since they require some CPU resources. The network status should only be readout once after system start and every time operator causes a change in the network layout.

Example:

Readout assoclist, bitrate and signal quality from wlan0-2 (CyAP0_00486889_00486886_vlan123)

```
assoclist_wlan0-2 1.3.6.1.4.1.2021.8.1.2.202
bitrate_wlan0-2 1.3.6.1.4.1.2021.8.1.2.242
signal_wlan0-2 1.3.6.1.4.1.2021.8.1.2.282
```

The command

```
snmpget -c public -v 2c 192.168.100.1 1.3.6.1.4.1.2021.8.1.2.202.101.1
```

returns the assoclist

```
iso.3.6.1.4.1.2021.8.1.2.202.101.1 = STRING: "06:0E:8E:67:08:64"
```

The command

```
snmpget -c public -v 2c 192.168.100.1 1.3.6.1.4.1.2021.8.1.2.242.101.1
```

returns the bitrate information

```
iso.3.6.1.4.1.2021.8.1.2.242.101.1 = STRING: "65.0 Mbit/s"
```

The command

```
snmpget -c public -v 2c 192.168.100.1 1.3.6.1.4.1.2021.8.1.2.282.101.1
```

returns the signal quality information

```
iso.3.6.1.4.1.2021.8.1.2.282.101.1 = STRING: "Link Quality: 70/70 Signal: -33 dBm Noise: -95 dBm "
```

7.7 SNMP Write (snmpset)

By default all SNMP write control is restricted to localhost. Refer to chapter 8.1 to enable write access.

A write command to the CyBox GW is always done on the same UCD MIB OID '1.3.6.1.4.1.2021.8.1'. The write operation requires a string parameter, which is parsed with '/etc/snmp/set_cyboxap' and translated into a system internal call on the CyBox GW. Consider that all writes to a configuration item are permanently stored in the overlay file system and will be present after next power cycle.

Usage of the SNMPSET system call:

```
snmpset -c private -v 2c <IPv4> 1.3.6.1.4.1.2021.8.1 s <command string or set entry string>
```

The given parameter string can be for example:

Command Type	Parameter String
Direct command	"radio0_up" "radio0_down" "modem0_up" "modem0_down" ... see Appendix for all commands "reboot"
System service action	"service <name> <action>"
UCI configuration call	"uci <command> <config>.<section> [<option>]=<value>"
Configuration set to new value	"network<index>.<entry> <value>" "radio<index>.<entry> <value>" "wireless<index>.<entry> <value>"

7.7.1 Direct command

7.7.1.1 Reboot

```
snmpset -c private -v 2c 192.168.100.1 1.3.6.1.4.1.2021.8.1 s "reboot"
```

7.7.2 Edit configuration using Object Identifier (OID)

7.7.2.1 Set a new IP address

```
snmpset -c private -v 2c 192.168.100.1 1.3.6.1.4.1.2021.8.1 s "network5.ipaddr 192.168.20.20"
snmpset -c private -v 2c 192.168.100.1 1.3.6.1.4.1.2021.8.1 s "uci commit network"
snmpset -c private -v 2c 192.168.100.1 1.3.6.1.4.1.2021.8.1 s "service network reload"
```

7.7.2.2 Set a new SSID

```
snmpwalk -c public -v 2c 192.168.100.1 1.3.6.1.4.1.2021.8.1.2.151
iso.3.6.1.4.1.2021.8.1.2.151.1.1 = INTEGER: 1
iso.3.6.1.4.1.2021.8.1.2.151.2.1 = STRING: "ssid_order"
iso.3.6.1.4.1.2021.8.1.2.151.3.1 = STRING: "/etc/snmp/get_cyboxap ssid_order"
iso.3.6.1.4.1.2021.8.1.2.151.100.1 = INTEGER: 0
iso.3.6.1.4.1.2021.8.1.2.151.101.1 = STRING: "CyAP0_00486889_00486886_EST0"
iso.3.6.1.4.1.2021.8.1.2.151.101.2 = STRING: "Guest_007"
iso.3.6.1.4.1.2021.8.1.2.151.101.3 = STRING: "CyAP0_00486889_00486886_vlan007"
iso.3.6.1.4.1.2021.8.1.2.151.101.4 = STRING: "CyAP0_00486889_00486886_vlan123"
iso.3.6.1.4.1.2021.8.1.2.151.101.5 = STRING: "CyAP0_00486889_00486886_vlan500"
iso.3.6.1.4.1.2021.8.1.2.151.101.6 = STRING: "CyAP0_00486889_00486886_cfg_net"
iso.3.6.1.4.1.2021.8.1.2.151.101.7 = STRING: "Guest_123" <== change index 6
iso.3.6.1.4.1.2021.8.1.2.151.101.8 = STRING: "VIP_500"
iso.3.6.1.4.1.2021.8.1.2.151.102.1 = INTEGER: 0
iso.3.6.1.4.1.2021.8.1.2.151.103.1 = ""
```

Get radio module from wireless6.device=1.3.6.1.4.1.2021.8.1.2.1440 (may be omitted if SSID-radio is known):

```
snmpget -c public -v 2c 192.168.100.1 1.3.6.1.4.1.2021.8.1.2.1440.101.1
```

delivers

```
iso.3.6.1.4.1.2021.8.1.2.1440.101.1 = STRING: "radio1"
snmpset -c private -v 2c 192.168.100.1 1.3.6.1.4.1.2021.8.1 s "wireless6.ssid New_345"
snmpset -c private -v 2c 192.168.100.1 1.3.6.1.4.1.2021.8.1 s "uci commit wireless"
snmpset -c private -v 2c 192.168.100.1 1.3.6.1.4.1.2021.8.1 s "service network reload"
```

7.7.2.3 Set a new Macfilter

Apply a new 'macfilter' on the access point "VIP_500". Specific user mac is excluded.

```
snmpset -c private -v 2c 192.168.100.1 1.3.6.1.4.1.2021.8.1 s
"wireless7.macfilter deny"
```

Single user:

```
snmpset -c private -v 2c 192.168.100.1 1.3.6.1.4.1.2021.8.1 s
"wireless7.maclist 11:22:33:44:55:66"
```

Multiple user:

```
snmpset -c private -v 2c 192.168.100.1 1.3.6.1.4.1.2021.8.1 s "uci
add_list wireless.@wifi-\ face[7].maclist=11:22:33:44:55:66"

snmpset -c private -v 2c 192.168.100.1 1.3.6.1.4.1.2021.8.1 s "uci
add_list wireless.@wifi-face[7].maclist=22:33:44:55:66:77"

snmpset -c private -v 2c 192.168.100.1 1.3.6.1.4.1.2021.8.1 s "uci
commit wireless"

snmpset -c private -v 2c 192.168.100.1 1.3.6.1.4.1.2021.8.1 s "service
network reload"
```

7.7.3 Edit configuration parameters, create new fields and delete items

If a 'config.section.option' is known, the 'uci set' command call can be used to read and modify any existing configuration item. If a snmpset command with a string "uci <command> config-item=new-value" is executed, it marks the config-item. The next snmpget call with '1.3.6.1.4.1.2021.8.1.2.108' (uci_get) remembers the last config-item and returns the current value (read-back function). If the snmpset was executed without the string part "=new-value" only the config-item marker is set. This can be used to readout an item (no OID) without modifying it.

Note: Remember to commit changes in order to save then with the command 'uci commit'.

7.7.3.1 Set new Hostname

Hostname is configured in '/etc/config/system' (no OID).

The commands

```
snmpset -c private -v 2c 192.168.100.1 1.3.6.1.4.1.2021.8.1 s "uci set
system.@system[0].hostname"

snmpwalk -c public -v 2c 192.168.100.1 1.3.6.1.4.1.2021.8.1.2.108
```

will deliver

```
iso.3.6.1.4.1.2021.8.1.2.108.1.1 = INTEGER: 1

iso.3.6.1.4.1.2021.8.1.2.108.2.1 = STRING: "uci_get"

iso.3.6.1.4.1.2021.8.1.2.108.3.1 = STRING: "/usr/sbin/get_snmp
uci_get"

iso.3.6.1.4.1.2021.8.1.2.108.100.1 = INTEGER: 0

iso.3.6.1.4.1.2021.8.1.2.108.101.1 = STRING:
"system.@system[0].hostname=CyBoxAP"

iso.3.6.1.4.1.2021.8.1.2.108.102.1 = INTEGER: 0

iso.3.6.1.4.1.2021.8.1.2.108.103.1 = ""
```

Use the following sequence to set the new hostname

```
snmpset -c private -v 2c 192.168.100.1 1.3.6.1.4.1.2021.8.1 s "uci set
system.@system[0].hostname=CYAP-14"

snmpset -c private -v 2c 192.168.100.1 1.3.6.1.4.1.2021.8.1 s "uci
commit system"

snmpset -c private -v 2c 192.168.100.1 1.3.6.1.4.1.2021.8.1 s "service
system reload"
```

7.7.3.2 Creating a system configuration description text

The regular firmware configuration does not provide such information. The following command sequence

```
snmpset -c private -v 2c 192.168.100.1 1.3.6.1.4.1.2021.8.1 s "uci set
system.@system[0].config_description=Version 1.1 Beta ABC"

snmpwalk -c public -v 2c 192.168.100.1 1.3.6.1.4.1.2021.8.1.2.108
```

delivers

```
iso.3.6.1.4.1.2021.8.1.2.108.1.1 = INTEGER: 1
iso.3.6.1.4.1.2021.8.1.2.108.2.1 = STRING: "uci_get"
iso.3.6.1.4.1.2021.8.1.2.108.3.1 = STRING: "/usr/sbin/get_snmp
uci_get"
iso.3.6.1.4.1.2021.8.1.2.108.100.1 = INTEGER: 0
iso.3.6.1.4.1.2021.8.1.2.108.101.1 = STRING:
"system.@system[0].config_description=Version 1.1 Beta ABC"
iso.3.6.1.4.1.2021.8.1.2.108.102.1 = INTEGER: 0
iso.3.6.1.4.1.2021.8.1.2.108.103.1 = ""
```

Commit this change from UCI temporary storage to permanent overlay file system.

```
snmpset -c private -v 2c 192.168.100.1 1.3.6.1.4.1.2021.8.1 s "uci
commit system"
```

No service reload is required.

7.7.3.3 Delete system configuration description text

The following command sequence

```
snmpset -c private -v 2c 192.168.100.1 1.3.6.1.4.1.2021.8.1 s "uci
delete system.@system[0].config_description"
snmpwalk -c public -v 2c 192.168.100.1 1.3.6.1.4.1.2021.8.1.2.108
```

delivers

```
iso.3.6.1.4.1.2021.8.1.2.108.1.1 = INTEGER: 1
iso.3.6.1.4.1.2021.8.1.2.108.2.1 = STRING: "uci_get"
iso.3.6.1.4.1.2021.8.1.2.108.3.1 = STRING: "/usr/sbin/get_snmp
uci_get"
iso.3.6.1.4.1.2021.8.1.2.108.100.1 = INTEGER: 0
iso.3.6.1.4.1.2021.8.1.2.108.101.1 = STRING: "uci: Entry not found"
iso.3.6.1.4.1.2021.8.1.2.108.101.2 = STRING:
"system.@system[0].config_description="
iso.3.6.1.4.1.2021.8.1.2.108.102.1 = INTEGER: 0
iso.3.6.1.4.1.2021.8.1.2.108.103.1 = ""
```

Commit this change from UCI temporary storage to permanent overlay file system.

```
snmpset -c private -v 2c 192.168.100.1 1.3.6.1.4.1.2021.8.1 s "uci
commit system"
```

7.8 SNMP Applications

7.8.1 SNMP Support for GPS

The following information data structure can be obtained via SNMP command 'snmpwalk' from a host system.

The command

```
user@host:~$ snmpwalk -c public -v2c 192.168.100.1
1.3.6.1.4.1.2021.8.1.2.155
```

delivers

```
iso.3.6.1.4.1.2021.8.1.2.155.1.1 = INTEGER: 1
iso.3.6.1.4.1.2021.8.1.2.155.2.1 = STRING: "gps_info"
iso.3.6.1.4.1.2021.8.1.2.155.3.1 = STRING: "/bin/cat
/var/run/gps/gps.info"
iso.3.6.1.4.1.2021.8.1.2.155.100.1 = INTEGER: 0
iso.3.6.1.4.1.2021.8.1.2.155.101.1 = STRING: "Status: A"
iso.3.6.1.4.1.2021.8.1.2.155.101.2 = STRING: "Quality: 1"
iso.3.6.1.4.1.2021.8.1.2.155.101.3 = STRING: "Sat: 9"
iso.3.6.1.4.1.2021.8.1.2.155.101.4 = STRING: "Wed Jul 5 09:45:15
2017"
iso.3.6.1.4.1.2021.8.1.2.155.101.5 = STRING: "N: 49.960107"
iso.3.6.1.4.1.2021.8.1.2.155.101.6 = STRING: "E: 8.258518"
iso.3.6.1.4.1.2021.8.1.2.155.101.7 = Hex-STRING: 4E 3A 20 34 39 C2
B0 35 37 27 33 36 2E 33 38 34
22
iso.3.6.1.4.1.2021.8.1.2.155.101.8 = Hex-STRING: 45 3A 20 38 C2 B0
31 35 27 33 30 2E 36 36 36 22
iso.3.6.1.4.1.2021.8.1.2.155.101.9 = STRING: "Alt: 175.75m"
iso.3.6.1.4.1.2021.8.1.2.155.101.10 = STRING: "Speed: 1 km/h"
iso.3.6.1.4.1.2021.8.1.2.155.101.11 = ""
iso.3.6.1.4.1.2021.8.1.2.155.102.1 = INTEGER: 0
iso.3.6.1.4.1.2021.8.1.2.155.103.1 = ""
```

The values "Latitude DMS" and "Longitude DMS" are returned as Hex strings because they contain quote and double quotes.

This converted NMEA 0183 data struct is supplied with default configuration (after factory reset). The configuration can be adapted to supply the raw NMEA 0183 protocol. Following steps are necessary to switch over to raw protocol.

Open a remote root console with 'ssh' access and apply following commands.

```

root@CyBoxAP:/# uci set system.@gps[0].raw='1'

root@CyBoxAP:/# uci commit

root@CyBoxAP:/# reboot

```

After reboot the GPS subsystem is configured to supply raw NMEA 0183 data. Note that this data is not shown in web interface, but can be readout via SNMP (different OID than converted GPS info).

The command

```

user@host:~$ snmpwalk -c public -v2c 192.168.100.1
1.3.6.1.4.1.2021.8.1.2.156

```

will return

```

iso.3.6.1.4.1.2021.8.1.2.156.1.1 = INTEGER: 1

iso.3.6.1.4.1.2021.8.1.2.156.2.1 = STRING: "gps_raw"

iso.3.6.1.4.1.2021.8.1.2.156.3.1 = STRING: "/bin/cat
/var/run/gps/gps.raw"

iso.3.6.1.4.1.2021.8.1.2.156.100.1 = INTEGER: 0

iso.3.6.1.4.1.2021.8.1.2.156.101.1 = STRING:
"$GPRMC,094908.000,A,4957.5942,N,00815.4955,E,0.2,194.2,050717,,A*6E"

iso.3.6.1.4.1.2021.8.1.2.156.101.2 = STRING:
"$GPGGA,094908.000,4957.5942,N,00815.4955,E,1,07,1.3,149.90,M,47.9,M,,*6E"

iso.3.6.1.4.1.2021.8.1.2.156.101.3 = STRING:
"$GNGSA,A,3,24,25,32,29,31,02,,,,,,2.2,1.3,1.8*2C"

iso.3.6.1.4.1.2021.8.1.2.156.101.4 = STRING:
"$GNGSA,A,3,77,,,,,,2.2,1.3,1.8*27"

iso.3.6.1.4.1.2021.8.1.2.156.101.5 = STRING:
"$GPGSV,3,1,10,02,39,076,17,06,13,033,,12,40,086,13,14,30,267,*7F"

iso.3.6.1.4.1.2021.8.1.2.156.101.6 = STRING:
"$GPGSV,3,2,10,24,12,151,34,25,79,051,21,26,02,280,,29,61,213,25*77"

iso.3.6.1.4.1.2021.8.1.2.156.101.7 = STRING:
"$GPGSV,3,3,10,31,40,305,25,32,22,244,32,,,,,,*7D"

iso.3.6.1.4.1.2021.8.1.2.156.101.8 = STRING:
"$GLGSV,2,1,07,81,19,201,,70,11,350,,77,42,124,33,79,34,317,*6F"

iso.3.6.1.4.1.2021.8.1.2.156.101.9 = STRING:
"$GLGSV,2,2,07,69,08,297,,88,69,171,,87,52,044,,,,,*59"

iso.3.6.1.4.1.2021.8.1.2.156.102.1 = INTEGER: 0

iso.3.6.1.4.1.2021.8.1.2.156.103.1 = ""

```

7.8.2 SNMP Support for Second GPS Source

On some CyBox AP models the LTE modem can also provide additional GPS information. If the modem GPS is activated, and an additional GPS antenna is plugged in, these SNMP OIDs can be used to gather the additional GPS information.

gps_module0_info	1.3.6.1.4.1.2021.8.1.2.157
gps_module0_raw	1.3.6.1.4.1.2021.8.1.2.158
gps_module1_info	1.3.6.1.4.1.2021.8.1.2.159
gps_module1_raw	1.3.6.1.4.1.2021.8.1.2.160

7.9 GPS

Some CyBox family members are equipped with an additional GNSS hardware module. The GPS antenna is routed to the front panel. Once an appropriate antenna is attached, the GPS signal is received and can be processed, if a version V3.03 or newer is installed. The GPS hardware supplies NMEA 0183 protocol on the second serial port, which is converted into a human-readable form.

7.9.1 GPS activation

The GPS is disabled by default. It can be enabled via the web interface. Enter **System** → **GPS Info** and check **Enable**.

Status	GPS Information	
System	Read GPS information from internal GPS chip and Modem devices.	
VPN		
Services	Interfaces	
Customize	Enable	<input type="checkbox"/>
SNMPD	Raw output	<input type="checkbox"/>
SNMPD Edit		<input checked="" type="checkbox"/> Enable raw output from GPS source
SNMP-Trap	Interface name	<input type="text" value="gps"/>
GPS Info		<input checked="" type="checkbox"/> Specifies the GPS Interface name
GPSD	Device name	<input type="text" value="ttyS1"/>
ICCP		<input checked="" type="checkbox"/> Specifies the serial output device of GPS source
Softflowd	Speed unit	<input type="text" value="km/h"/>
Network		
Statistics		

GPS Activation

7.9.2 GPS status

The GPS information will show on the **Status** → **Advanced** of the web interface. The next figure shows an example available immediately after startup. And the figure below provides the same status after the receiver has calibrated itself. The table below provides an interpretation of the GPS status data.

Status
Module Information
Revision Information
Temperature Sensors
GPS Sensors
ICCP
Self Test
License

- Overview
- Advanced
- Firewall
- Routes
- System Log
- Kernel Log
- Processes
- Realtime Graphs
- Load Balancing
- System
- VPN
- Services
- Network
- Statistics
- Logout

GPS Information

Internal GPS
=====

```

Status: V
Quality: 0
Sat: 0
Sun Jan 4 00:17:03 2009
N: 0.000000
E: 0.000000
N: 0°0'0.000"
E: 0°0'0.000"
Alt: 82.00m
Speed: 0 km/h
                    
```

GPS Info immediately after startup

Status
Module Information
Revision Information
Temperature Sensors
GPS Sensors

- Overview
- Advanced
- Firewall
- Routes
- System Log
- Kernel Log
- Processes
- Realtime Graphs
- Load Balancing
- System

GPS Information

Internal GPS
=====

```

Status: A
Quality: 1
Sat: 13
Thu Sep 10 12:38:31 2020
N: 49.960240
E: 8.258405
N: 49°57'36.864"
E: 8°15'30.258"
Alt: 147.57m
Speed: 0 km/h
                    
```

Reliable GPS Info after Hardware Calibration

GPS Status Data:

Data Item	Value	Description
Status	A	Active
	V	Void
Quality	0	Invalid
	1	GPS fix (SPS)

	2	DGPS fix
	3	PPS fix
	4	Real Time Kinematic
	5	Float RTK
	6	Estimated
	7	Manual input mode
	8	Simulation mode

7.9.3 SNMP for GPS

See chapter [SNMP Support for GPS](#)

7.9.4 SNMP Support for LTE

A number of LTE connection and control parameters can be read and written using SNMP commands. It is also possible to start or stop the LTE modem card and to select a predefined SIM card slot.

The SNMP OIDs are listed twice. The first installed LTE modem card uses SNMP calls starting with **modem0_xxx**, and the second modem card uses calls starting with **modem1_xxx**. Since both lists are otherwise identical, the description refers only to **modem0_xxx**.

7.9.4.1 LTE SNMP Read Control

Get Current LTE Configuration: modem0_config 1.3.6.1.4.1.2021.8.1.2.3000

The command

```
user@host:~$ snmpwalk -c public -v2c 192.168.100.1
1.3.6.1.4.1.2021.8.1.2.3000
```

returns

```
iso.3.6.1.4.1.2021.8.1.2.3000.1.1 = INTEGER: 1
iso.3.6.1.4.1.2021.8.1.2.3000.2.1 = STRING: "modem0_config"
iso.3.6.1.4.1.2021.8.1.2.3000.3.1 = STRING: "/usr/sbin/get_snmp
modem0_config"
iso.3.6.1.4.1.2021.8.1.2.3000.100.1 = INTEGER: 0
iso.3.6.1.4.1.2021.8.1.2.3000.101.1 = STRING:
"network.LTE=interface"
iso.3.6.1.4.1.2021.8.1.2.3000.101.2 = STRING:
"network.LTE.proto='qmi'"
iso.3.6.1.4.1.2021.8.1.2.3000.101.3 = STRING:
"network.LTE.ifname='wwan1'"
iso.3.6.1.4.1.2021.8.1.2.3000.101.4 = STRING:
"network.LTE.simslot='1'"
iso.3.6.1.4.1.2021.8.1.2.3000.101.5 = STRING:
"network.LTE.pincodel='4173'"
iso.3.6.1.4.1.2021.8.1.2.3000.102.1 = INTEGER: 0
iso.3.6.1.4.1.2021.8.1.2.3000.103.1 = ""
```

Get Current Modem Signal Quality: modem0_signal 1.3.6.1.4.1.2021.8.1.2.3010

The command

```
user@host:~$ snmpwalk -c public -v2c 192.168.100.1
1.3.6.1.4.1.2021.8.1.2.3010
```

returns

```
iso.3.6.1.4.1.2021.8.1.2.3010.1.1 = INTEGER: 1
iso.3.6.1.4.1.2021.8.1.2.3010.2.1 = STRING: "modem0_signal"
iso.3.6.1.4.1.2021.8.1.2.3010.3.1 = STRING: "/usr/sbin/get_snmp
```

```

modem0_signal"

iso.3.6.1.4.1.2021.8.1.2.3010.100.1 = INTEGER: 0

iso.3.6.1.4.1.2021.8.1.2.3010.101.1 = STRING: "[/dev/cdc-wdm1]
Successfully got signal info"

iso.3.6.1.4.1.2021.8.1.2.3010.101.2 = STRING: "HDR:"

iso.3.6.1.4.1.2021.8.1.2.3010.101.3 = STRING: " RSSI: '-125 dBm'"

iso.3.6.1.4.1.2021.8.1.2.3010.101.4 = STRING: " ECIO: '-2.5 dBm'"

iso.3.6.1.4.1.2021.8.1.2.3010.101.5 = STRING: " IO: '-106 dBm'"

iso.3.6.1.4.1.2021.8.1.2.3010.101.6 = STRING: " SINR (8): '9.0 dB'"

iso.3.6.1.4.1.2021.8.1.2.3010.101.7 = STRING: "LTE:"

iso.3.6.1.4.1.2021.8.1.2.3010.101.8 = STRING: " RSSI: '-56 dBm'"

iso.3.6.1.4.1.2021.8.1.2.3010.101.9 = STRING: " RSRQ: '-13 dB'"

iso.3.6.1.4.1.2021.8.1.2.3010.101.10 = STRING: " RSRP: '-86 dBm'"

iso.3.6.1.4.1.2021.8.1.2.3010.101.11 = STRING: " SNR: '19.2 dB'"

iso.3.6.1.4.1.2021.8.1.2.3010.102.1 = INTEGER: 0

iso.3.6.1.4.1.2021.8.1.2.3010.103.1 = ""

```

Get Current Modem DHCP Settings: modem0_dhcp_status 1.3.6.1.4.1.2021.8.1.2.3015

Use command

```

user@host:~$ snmpwalk -c public -v2c 192.168.100.1
1.3.6.1.4.1.2021.8.1.2.3015

```

returns

```

iso.3.6.1.4.1.2021.8.1.2.3015.1.1 = INTEGER: 1

iso.3.6.1.4.1.2021.8.1.2.3015.2.1 = STRING: "modem0_dhcp_status"

iso.3.6.1.4.1.2021.8.1.2.3015.3.1 = STRING: "/usr/sbin/get_snmp
modem0_dhcp_status"

iso.3.6.1.4.1.2021.8.1.2.3015.100.1 = INTEGER: 0

iso.3.6.1.4.1.2021.8.1.2.3015.101.1 = STRING:
"{\"up\":true,\"pending\":false,\"available\":true,\"autostart\":true,\"dynamic\":true,
\"uptime\":437,\"l3_device\":\"wwan1\",\"proto\":\"dhcp\",\"device\":\"wwan1\",
\"updated\":[\"addresses\",\"routes\",\"data\"],\"metric\":0,\"dns_metric\":0,
\"delegation\":true,\"ipv4-address\":{\"address\":\"10.118.124.205\",\"mask\":\"30\"},
\"ipv6-address\":[],\"ipv6-prefix\":[],\"ipv6-prefix-assignment\":[],
\"route\":{\"target\":\"10.118.124.206\",\"mask\":\"32\",\"nexthop\":\"0.0.0.0\",
\"source\":\"10.118.124.205\\/32\"},{\"target\":\"0.0.0.0\",\"mask\":\"0,
\"nexthop\":\"10.118.124.206\",\"source\":\"10.118.124.205\\/32\"}},
\"dns-server\":{\"62.109.121.17\",\"62.109.121.18\"},\"dns-search\":[],
\"inactive\":{\"ipv4-address\":[],\"ipv6-address\":[],\"route\":[],\"dns-server\":[],
\"dns-search\":[],\"data\":{\"leasetime\":7200}}"

iso.3.6.1.4.1.2021.8.1.2.3015.102.1 = INTEGER: 0

```

```
iso.3.6.1.4.1.2021.8.1.2.3015.103.1 = ""
```

7.9.4.2 LTE SNMP Write Control

By default SNMP write control is restricted to the localhost. Refer to chapter 8.1 to enable write access.

Any changes on provider settings e.g. APN, PIN, etc. must be done in the web interface. For SNMP writing only switching between preconfigured SIM cards is supported.

Activate/Deactivate Network Interface my_lte

Use commands

```
snmpset -c private -v 2c 192.168.100.1 1.3.6.1.4.1.2021.8.1 s
"modem0_up"

snmpset -c private -v 2c 192.168.100.1 1.3.6.1.4.1.2021.8.1 s
"modem0_down"
```

Select another SIM card slot and restart network

Use commands

```
snmpset -c private -v 2c 192.168.100.1 1.3.6.1.4.1.2021.8.1 s
"modem0_simslot 1"

snmpset -c private -v 2c 192.168.100.1 1.3.6.1.4.1.2021.8.1 s "
modem0_simslot 2"

snmpset -c private -v 2c 192.168.100.1 1.3.6.1.4.1.2021.8.1 s
"modem0_simslot 3"

snmpset -c private -v 2c 192.168.100.1 1.3.6.1.4.1.2021.8.1 s
"modem0_simslot 4"
```

8 THE FLYING CONTROLLER MECHANISM

Some tasks require knowledge which is not available at a single network node. For example, to detect a “rogue access point”, all access points belonging to the WLAN network must be known, in order to identify those who don’t. Also, multiple access points scan the vicinity, and their results have to be collected and evaluated at one central point. Therefore a single “controller” is needed in the network which collects those information and then performs the rogue AP detection.

The “flying controller” is an algorithm which runs on multiple network devices simultaneously and which elects one of these devices as the “controller”. All other devices are called “workers”. If the controller fails, a new one is elected, hence the term “flying”. This way, a central controller is established without creating a single point of failure.

The CyBox GW automatically takes part on the mechanism and could be elected as controller, or otherwise will be a worker.

The election mechanism is the foundation for the [6.1.2.10 Rogue Access Point Detection Service](#) . This service runs on the controller and collects data from the workers to detect rogue APs.

The flying controller mechanism has no configuration options.

9 IPsecVPN / StrongSwan

strongSwan is a multiplatform IPsec implementation. The focus of the project is on strong authentication mechanisms using X.509 public key certificates and optional secure storage of private keys and certificates on smartcards through a standardized PKCS#11 interface and on TPM 2.0.

Detailed information about the **strongSwan IPsec** implementation can be found here:

<https://www.strongswan.org/about.html>

<https://wiki.strongswan.org/projects/strongswan>

9.1 IPsec Customized Configuration

The implementation of the IPsecVPN as a the OpenWrt service requires three service conform config files out of the OpenWrt configuration file `/etc/config/ipsec`.

These three standard configuration files are:

- `IPSEC_SECRETS_FILE=/etc/ipsec.secrets`
- `IPSEC_CONN_FILE=/etc/ipsec.conf`
- `STRONGSWAN_CONF_FILE=/etc/strongswan.conf`

When IPsec service is started, the configuration file `/etc/config/ipsec` is converted into three volatile config include files located in `/var/ipsec/`

- `IPSEC_VAR_SECRETS_FILE=/var/ipsec/ipsec.secrets`
- `IPSEC_VAR_CONN_FILE=/var/ipsec/ipsec.conf`
- `STRONGSWAN_VAR_CONF_FILE=/var/ipsec/strongswan.conf`

These three standard configuration files can be modified with internal **nano** editor or on an external host and transferred back via `scp` to the target system.

9.2 IPsec Firewall Custom Rules

The standard firewall setup (factory default) may require new custom rules to handle IPsec ESP package forwarding.

Status	General Settings Port Forwards Traffic Rules Custom Rules
System	Firewall - Custom Rules
VPN	Custom rules allow you to execute arbitrary iptables commands which are not otherwise covered by the firewall framework. The commands are executed after each firewall restart, right after the default ruleset has been loaded.
Services	
Network	
Interfaces	
DHCP and DNS	
Hostnames	
Static Routes	
Diagnostics	
Firewall	<pre># This file is interpreted as shell script. # Put your custom iptables rules here, they will # be executed with each firewall (re-)start. # Internal uci firewall chains are flushed and recreated on reload, so # put custom rules into the root chains e.g. INPUT or FORWARD or into the # special user chains, e.g. input_wan_rule or postrouting_lan_rule. iptables -I INPUT -m policy --dir in --pol ipsec --proto esp -j ACCEPT iptables -I FORWARD -m policy --dir in --pol ipsec --proto esp -j ACCEPT iptables -I FORWARD -m policy --dir out --pol ipsec --proto esp -j ACCEPT iptables -I OUTPUT -m policy --dir out --pol ipsec --proto esp -j ACCEPT</pre>
Client Isolation	
Connection Check	
QoS	
Configure Diagnostics	
Load Balancing	
Statistics	
Logout	

[Restart Firewall](#) [Reset](#)

The firewall obtained some additional custom rules

Cut and Paste buffer for IPsec Firewall - Custom Rules edit:

```
iptables -I INPUT -m policy --dir in --pol ipsec --proto esp -j ACCEPT
iptables -I FORWARD -m policy --dir in --pol ipsec --proto esp -j ACCEPT
iptables -I FORWARD -m policy --dir out --pol ipsec --proto esp -j ACCEPT
iptables -I OUTPUT -m policy --dir out --pol ipsec --proto esp -j ACCEPT
```

10 SSH / SERIAL CONSOLE

On a Windows PC, you can use the program PuTTY (<http://www.putty.org>).

a. Ethernet cable (SSH)

Ensure that an Ethernet cable is connected between your PC and the access point. The following instruction assumes that the default settings are used.

- If you are using a UNIX/Linux PC then run the command 'ssh root@192.168.100.1'.
- If you are using a Windows PC, PuTTY should be configured as follows:

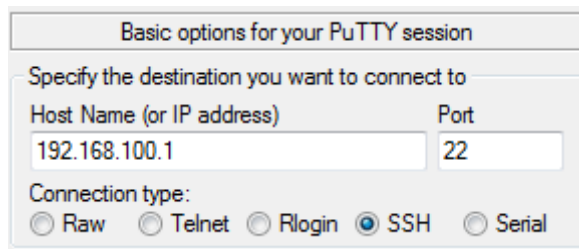

PuTTY - SSH connection

b. Serial cable

Ensure that a serial cable is connected between your PC and the access point (a specific CyBox adapter plugged in the USB port is required).

- On a UNIX PC, install the program picocom, and run command picocom -b 115200 /dev/ttyUSB0 ('ttyUSB0' must be modified depending on your PC).
- If you are using a Windows PC, PuTTY should be configured as follows:

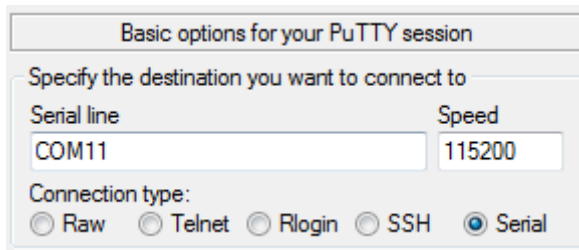

PuTTY - Serial connection

The value 'COM11' must be adapted for your PC. A list of the COM ports can be found in the device manager window as shown below.

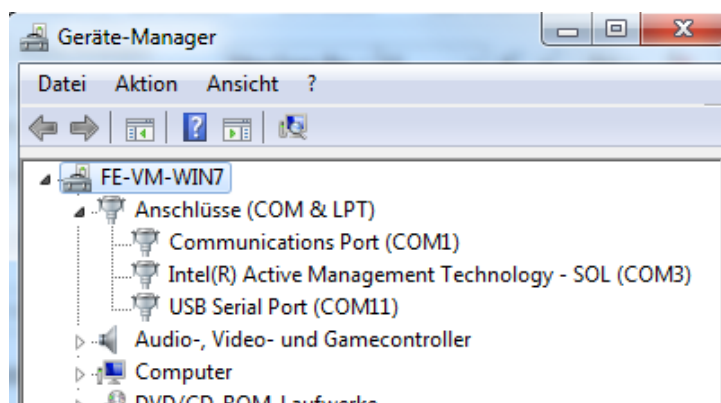

Windows device manager showing COM ports

Once the connection is established, a login should be requested on serial console window.

If this is not the case, press Enter on the keyboard and/or disconnect and reconnect the USB serial adapter on the CyBox side. To edit files on target system the build-in text editor **nano** can be used.

10.1 UCI Configuration

This section describes the UCI (**Unified Configuration Interface**). UCI can be scripted for remote configuration using shell commands and scripts. UCI can be seen as the OpenWRT main configuration interface. It is best used for main network interface configuration, wireless settings, logging functionality and remote access configuration.

With OpenWrt, the user should change only UCI configuration file(s), which are read by individual programs.

For a more complete description of UCI commands and files used see <https://wiki.openwrt.org/doc/uci>.

10.1.1 UCI configuration files

The OpenWRT central configuration is split into several files located in the `/etc/config/` directory. Each file is named according to the part of the system it configures. The configuration files can either be modified using a text editor or by using UCI. UCI configuration files are also modifiable through various programming APIs (like Shell, Lua and C), which is also how web interfaces like LuCI make changes to the UCI files.

After changing a UCI configuration file, the services affected must be restarted by an `init.d` call, so the updated UCI configuration is used. Many programs are made compatible with UCI by making their `init.d` script write their standard program-specific configuration files. The `init.d` script first writes the configuration file to the location expected by the software and it is read in again by restarting the executable. Note that just (re)starting the executable directly, without `init.d` calls, will not result in an UCI update. Changes in files in `/etc/config/` then take no effect.

10.1.2 UCI Example

As an example, suppose you want to change the device's IP address from the default 192.168.100.1 to 192.168.2.1. Change the line in the file `/etc/config/network`:

```
option ipaddr 192.168.100.1
```

to:

```
option ipaddr 192.168.2.1
```

Next, commit the settings by running:

```
/etc/init.d/network restart
```

Remember to login again to the new IP address.

10.2 Other commands

a. Restore factory settings

The factory settings can be restored with the command `factory_reset`

b. Export configuration

The current configuration can be saved in the CyBox folder *'/tmp/* with the command `sysupgrade -b /tmp/backup<mybackupname>.tar.gz`. It can then be exported to a PC with SCP (or the program WinSCP for Windows).

c . Import configuration

Restore the factory settings and then import your archived configuration to *'/tmp/* with SCP (or WinSCP), the configuration can be installed with the command `sysupgrade -r /tmp/backup-<mybackupname>.tar.gz ; reboot`

Typing `reboot` in the command line will reboot the device.

USB stick is auto-mounted to `/mnt/sda1`.

11 Serial Module SMX-200

The Vecow SMX-200 is a mPCIe module providing 4 serial interfaces. It is used in CYGWP-2040, for example. Each interface can be used as RS232, RS422 or RS485 or it can be set to loopback mode.

To operate the module, the OpenWRT firmware must provide the driver `xr16v35x` and a configuration tool `exar_pci_mode_config_utils`. Since version V22.50.01 these components are integrated into CyBox-GW-P 1/2 firmware.

11.1 Connectors on front panel

At the time of writing this, the SMX-200 is only used in the CYGWP-2040. Only three UARTs (0-2) are accessible on the CYGWP-2040 front panel. The port numbers 1, 2 and 3 are used as linux devices: `/dev/ttyXR0`, `/dev/ttyXR1` and `/dev/ttyXR2`.

The Pin-out of the port connectors is as follows:

Pin No.	RS-232	RS-422 (5-wire)	RS-485 (3-wire)
1	GND_EARTH	GDN_EARTH	GND_EARTH
2	GND	GND	GND
3	RI	-	RI
4	DTR	RXD-	-
5	CTS	-	-
6	TXD	RXD+	-
7	RTS	-	-
8	RXD	TXD+	DATA+
9	DSR	-	-
10	DCD	TXD-	DATA-

11.2 Serial Driver

The `r17v35x` driver is the kernel module to operate the UARTs. The `xr16v35x` module is auto-loaded at boot time and creates the device files `/dev/ttyXR0` to `/dev/ttyXR3`.

11.3 Port Configuration Tool

The `exar_pci_mode_config_utils` is a user space program to configure baudrate, mode and other aspects of the UARTs. Note that it works only for the SMX-200 UARTs.

11.4 Using the SMX-200 UARTs

Before using the UARTs, they must be configured. Example:

```
# Keep the UART port open (PORT #1 on front panel)
exec 3< /dev/ttyXR0 >/dev/null

# Init UART serial port to RS232 mode with hardware handshake
exar_pci_mode_config_utils port=0 mode=rs232 baud=115200 format=8N1 flowmode=rts/cts &>/dev/null
sleep 1
```

```
# Switching serial mode may produce a unintentional single char - read away
cat /dev/ttyXR0 >/dev/null &
xr_cat_pid=$!
sleep 1
kill $xr_cat_pid
```

12 SYSTEM MAINTENANCE

12.1 Remote Firmware Upgrade

The *standard_boot* flash partition, which contains the standard firmware binary image (.itb image), can be updated remotely. The new firmware image must be copied to the target system with **scp** command. Afterwards **ssh** calls will execute local target programs to install the new firmware.

While OpenWrt operating system is running, the *standard_boot* partition can be written at any time.

If firmware update does **not** require a configuration change, the current system configuration can be kept. Please contact support or sales department if a configuration reset is needed for your update purpose from an older version to a newer one.

The **Appendix: Script for Remote Firmware Update** provides a *Bash* script **rsysupgrade.sh** to demonstrate the remote update process from a Linux Host console.

12.1.1 Remote Firmware Upgrade without Config Change

Normally a firmware update should also include a configuration reset to the new version. Only in some few cases e.g. a small bug fix on a wireless driver, will not require to adapt and install a new configuration backup archive.

The following commands may be executed from a Linux console or with similar Windows **Putty** utils.

1. Copy the new firmware image to the target system

```
scp <new_firmware.itb> root@<target_ipv4>:/tmp/firmware.img
```
2. Flash new firmware to the **standard_boot** flash partition (mtd2) and reboot the target system

```
ssh root@<target_ipv4>: "/sbin/sysupgrade -t /tmp/firmware.img; reboot"
```

12.1.2 Remote Firmware Upgrade with New Config

In most cases an adapted or new configuration archive must also be installed, to match the new firmware version. The overlay partition is used to keep the configuration settings made by user to be present after power cycle. If the firmware detects an empty (cleared) overlay partition, the target directory **/mnt/custom/** is checked for a single **backup-<target>-<cfg>.tar.gz** archive to be installed as a new configuration. If a **/mnt/custom/backup-<target>-<cfg>.tar.gz** archive does **not** exist, the *factory* default settings are applied.

To create your custom configuration for a new firmware, the old system firmware should be updated to the new version with deleted configuration and *factory* settings applied. Make your complete system configuration setup with the new firmware version and save the **backup-<target>-<cfg>.tar.gz** archive to your Host System. The uploaded backup archive can then be exported to other (stationary) targets with the same hardware components equipped.

The following commands may be executed from a Linux console or with similar Windows **Putty** utils.

1. Copy the new firmware image to the target system

```
scp <new_firmware.itb> root@<target_ipv4>:/tmp/firmware.img
```
2. Flash new firmware to the **standard_boot** flash partition (mtd2)

```
ssh root@<target_ipv4>: "/sbin/sysupgrade -t /tmp/firmware.img"
```

3. Ensure that no backup configuration is stored in **/mnt/custom/**

```
ssh root@<target_ipv4>: "rm -rf /mnt/custom/backup*"
```

4. Optionally, export your new custom configuration to **/mnt/custom/**. *Note* that the target system will perform a extra reboot cycle, to activate your new configuration setup. If no configuration is exported, the default configuration of the new firmware will automatically be applied.

```
scp backup-<my_config>.tar.gz root@/<target_ipv4>:/mnt/custom/
```

5. Delete the current configuration and reboot:

```
ssh root@<target_ipv4>: "rm -rf /mnt/jffs2/*; reboot"
```

WARNING: Do NOT POWER OFF the access point while upgrading/restoring firmware to flash

12.2 USB Possibilities

Via USB stick it is possible to update configuration and firmware.

A USB stick can be connected to the device, it needs a dedicated USB adapter.

a. Export configuration

Archived configurations can be exported from the command line to an empty USB stick by copying the configuration to `/mnt/sda1`.

b. Import configuration

To import an archived configuration to the access point, wait until booting is completed, then connect a USB stick with a configuration file on it named like `'backup-<mycustomname>.tar.gz'` No other file or folder must be present on the stick. Once plugged in, the configuration will be automatically read in and two reboots will successively happen in order to apply your settings. The USB stick can safely be removed at the beginning of a boot phase (when all LEDs are turned off), or when the boot sequence is completed.

A USB hotplug script is triggered if the USB stick is plugged in after booting. It reads the root directory of the stick and checks for a list of known file types:

Files on upgrade USB stick:

File Type (wildcard=*)	Description	Board	Action	Who ?
"backup*tar.gz"	New configuration archive	ALL	Untar to Overlay FS (/dev/mtd3)	End user
"factory*reboot"	Marker to do a factory reset and reboot after upgrade operation.	ALL	Execute factory_reset	End user
"config*reboot"	Marker to do a perform a normal reboot.	ALL	Execute reboot	End user
"cyap*upgrade*tgz" "cyap*upgrade*zip"	Upgrade archive must contain an 'install.sh' script (executable) in archive root. The archive is unpacked to /tmp/usb_upgrade and 'install.sh' is executed.	ALL	Shell script execution	System Integrator

Every install is executed only once for each file on the USB stick; updates already installed are not tried again. Check `'System Log'` in web interface or logread on console for upgrade messages.

For a firmware upgrade with *.zip archive the USB stick should only provide one archive file in USB root directory:

Example:

cyap-upgrade-V20.36.3.zip

This upgrade archive file must contain the new `V20.36.3-cyap2-lzma.itb` firmware image and an executable install script named `install.sh`. The install script executes commands to flash the new firmware into the desired partition. The upgrade archive may also include a new configuration backup archive, suitable for the new firmware version. After firmware upgrade, the new configuration may also be applied with commands from the install script.

Example for an `install.sh` script:

```
#!/bin/sh
```

```
sysupgrade -t V20.36.3-cyap2-lzma.itb
sysupgrade -r backup-cyap2-20.36.3.tar.gz

exit 0
```

12.3 Status LED Blink Codes

While the upgrade process is running or has finished the 'Fail LED' (red/green) is used as status indicator.

Blink codes in upgrades:

Blink Code repeated	Description
RED 0.2sec on - GREEN 0.2sec on	Upgrade process running
GREEN continuous on	Upgrade successful
RED continuous on	USB stick mount failed
RED 3sec on - OFF 0.5sec	Mount of overlay FS failed
GREEN 3sec on - OFF 0.5sec	Some Upgrade is already one
RED 0.2sec - OFF 0.5sec - RED 0.2sec - OFF 2sec	Copy to flash failed
RED 0.2sec - OFF 0.5sec - RED 0.2sec - OFF 0.5sec - RED 0.2sec OFF 2sec	'install.sh' missing
GREEN 0.2sec - OFF 0.5sec - RED 0.2sec - OFF 0.5sec - RED 0.2sec - OFF 0.5sec	Password missing
GREEN 0.2sec - OFF 0.5sec - RED 0.2sec - OFF 0.5sec - RED 0.2sec - OFF 0.5sec - RED 0.2sec - OFF 0.5sec	Password invalid
OFF	USB stick is removed

13 APPENDIX: GPL LICENSE

GNU GENERAL PUBLIC LICENSE

Version 3, 29 June 2007

Copyright © 2007 Free Software Foundation, Inc. <<https://fsf.org/>>

Everyone is permitted to copy and distribute verbatim copies of this license document, but changing it is not allowed.

PREAMBLE

The GNU General Public License is a free, copyleft license for software and other kinds of works.

The licenses for most software and other practical works are designed to take away your freedom to share and change the works. By contrast, the GNU General Public License is intended to guarantee your freedom to share and change all versions of a program--to make sure it remains free software for all its users. We, the Free Software Foundation, use the GNU General Public License for most of our software; it applies also to any other work released this way by its authors. You can apply it to your programs, too.

When we speak of free software, we are referring to freedom, not price. Our General Public Licenses are designed to make sure that you have the freedom to distribute copies of free software (and charge for them if you wish), that you receive source code or can get it if you want it, that you can change the software or use pieces of it in new free programs, and that you know you can do these things.

To protect your rights, we need to prevent others from denying you these rights or asking you to surrender the rights. Therefore, you have certain responsibilities if you distribute copies of the software, or if you modify it: responsibilities to respect the freedom of others.

For example, if you distribute copies of such a program, whether gratis or for a fee, you must pass on to the recipients the same freedoms that you received. You must make sure that they, too, receive or can get the source code. And you must show them these terms so they know their rights.

Developers that use the GNU GPL protect your rights with two steps: (1) assert copyright on the software, and (2) offer you this License giving you legal permission to copy, distribute and/or modify it.

For the developers' and authors' protection, the GPL clearly explains that there is no warranty for this free software. For both users' and authors' sake, the GPL requires that modified versions be marked as changed, so that their problems will not be attributed erroneously to authors of previous versions.

Some devices are designed to deny users access to install or run modified versions of the software inside them, although the manufacturer can do so. This is fundamentally incompatible with the aim of protecting users' freedom to change the software. The systematic pattern of such abuse occurs in the area of products for individuals to use, which is precisely where it is most unacceptable. Therefore, we have designed this version of the GPL to prohibit the practice for those products. If such problems arise substantially in other domains, we stand ready to extend this provision to those domains in future versions of the GPL, as needed to protect the freedom of users.

Finally, every program is threatened constantly by software patents.

States should not allow patents to restrict development and use of software on general-purpose computers, but in those that do, we wish to avoid the special danger that patents applied to a free program could make it effectively proprietary. To prevent this, the GPL assures that patents cannot be used to render the program non-free.

The precise terms and conditions for copying, distribution and modification follow.

TERMS AND CONDITIONS

0. Definitions.

"This License" refers to version 3 of the GNU General Public License.

"Copyright" also means copyright-like laws that apply to other kinds of works, such as semiconductor masks.

"The Program" refers to any copyrightable work licensed under this License. Each licensee is addressed as "you". "Licensees" and "recipients" may be individuals or organizations.

To "modify" a work means to copy from or adapt all or part of the work in a fashion requiring copyright permission, other than the making of an exact copy. The resulting work is called a "modified version" of the earlier work or a work "based on" the earlier work.

A "covered work" means either the unmodified Program or a work based on the Program.

To "propagate" a work means to do anything with it that, without permission, would make you directly or secondarily liable for infringement under applicable copyright law, except executing it on a computer or modifying a private copy. Propagation includes copying, distribution (with or without modification), making available to the public, and in some countries other activities as well.

To "convey" a work means any kind of propagation that enables other parties to make or receive copies. Mere interaction with a user through a computer network, with no transfer of a copy, is not conveying.

An interactive user interface displays "Appropriate Legal Notices" to the extent that it includes a convenient and prominently visible feature that (1) displays an appropriate copyright notice, and (2) tells the user that there is no warranty for the work (except to the extent that warranties are provided), that licensees may convey the work under this License, and how to view a copy of this License. If the interface presents a list of user commands or options, such as a menu, a prominent item in the list meets this criterion.

1. Source Code.

The "source code" for a work means the preferred form of the work for making modifications to it. "Object code" means any non-source form of a work.

A "Standard Interface" means an interface that either is an official standard defined by a recognized standards body, or, in the case of interfaces specified for a particular programming language, one that is widely used among developers working in that language.

The "System Libraries" of an executable work include anything, other than the work as a whole, that (a) is included in the normal form of packaging a Major Component, but which is not part of that Major Component, and (b) serves only to enable use of the work with that Major Component, or to implement a Standard Interface for which an

implementation is available to the public in source code form. A "Major Component", in this context, means a major essential component (kernel, window system, and so on) of the specific operating system (if any) on which the executable work runs, or a compiler used to produce the work, or an object code interpreter used to run it.

The "Corresponding Source" for a work in object code form means all the source code needed to generate, install, and (for an executable work) run the object code and to modify the work, including scripts to control those activities. However, it does not include the work's System Libraries, or general-purpose tools or generally available free programs which are used unmodified in performing those activities but which are not part of the work. For example, Corresponding Source includes interface definition files associated with source files for the work, and the source code for shared libraries and dynamically linked subprograms that the work is specifically designed to require, such as by intimate data communication or control flow between those subprograms and other parts of the work.

The Corresponding Source need not include anything that users can regenerate automatically from other parts of the Corresponding Source.

The Corresponding Source for a work in source code form is that same work.

2. Basic Permissions.

All rights granted under this License are granted for the term of copyright on the Program, and are irrevocable provided the stated conditions are met. This License explicitly affirms your unlimited permission to run the unmodified Program. The output from running a covered work is covered by this License only if the output, given its content, constitutes a covered work. This License acknowledges your rights of fair use or other equivalent, as provided by copyright law.

You may make, run and propagate covered works that you do not convey, without conditions so long as your license otherwise remains in force. You may convey covered works to others for the sole purpose of having them make modifications exclusively for you, or provide you with facilities for running those works, provided that you comply with the terms of this License in conveying all material for which you do not control copyright. Those thus making or running the covered works for you must do so exclusively on your behalf, under your direction and control, on terms that prohibit them from making any copies of your copyrighted material outside their relationship with you.

Conveying under any other circumstances is permitted solely under the conditions stated below. Sublicensing is not allowed; section 10 makes it unnecessary.

3. Protecting Users' Legal Rights From Anti-Circumvention Law.

No covered work shall be deemed part of an effective technological measure under any applicable law fulfilling obligations under article 11 of the WIPO copyright treaty adopted on 20 December 1996, or similar laws prohibiting or restricting circumvention of such measures.

When you convey a covered work, you waive any legal power to forbid circumvention of technological measures to the extent such circumvention is effected by exercising rights under this License with respect to the covered work, and you disclaim any intention to limit operation or modification of the work as a means of enforcing, against the work's users, your or third parties' legal rights to forbid circumvention of technological measures.

4. Conveying Verbatim Copies.

You may convey verbatim copies of the Program's source code as you receive it, in any medium, provided that you conspicuously and appropriately publish on each copy an appropriate copyright notice; keep intact all notices stating that this License and any non-permissive terms added in accord with section 7 apply to the code; keep intact all notices of the absence of any warranty; and give all recipients a copy of this License along with the Program.

You may charge any price or no price for each copy that you convey, and you may offer support or warranty protection for a fee.

5. Conveying Modified Source Versions.

You may convey a work based on the Program, or the modifications to produce it from the Program, in the form of source code under the terms of section 4, provided that you also meet all of these conditions:

a) The work must carry prominent notices stating that you modified it, and giving a relevant date. b) The work must carry prominent notices stating that it is released under this License and any conditions added under section 7. This requirement modifies the requirement in section 4 to "keep intact all notices". c) You must license the entire work, as a whole, under this License to anyone who comes into possession of a copy. This License will therefore apply, along with any applicable section 7 additional terms, to the whole of the work, and all its parts, regardless of how they are packaged. This License gives no permission to license the work in any other way, but it does not invalidate such permission if you have separately received it. d) If the work has interactive user interfaces, each must display Appropriate Legal Notices; however, if the Program has interactive interfaces that do not display Appropriate Legal Notices, your work need not make them do so.

A compilation of a covered work with other separate and independent works, which are not by their nature extensions of the covered work, and which are not combined with it such as to form a larger program, in or on a volume of a storage or distribution medium, is called an "aggregate" if the compilation and its resulting copyright are not used to limit the access or legal rights of the compilation's users beyond what the individual works permit. Inclusion of a covered work in an aggregate does not cause this License to apply to the other parts of the aggregate.

6. Conveying Non-Source Forms.

You may convey a covered work in object code form under the terms of sections 4 and 5, provided that you also convey the machine-readable Corresponding Source under the terms of this License, in one of these ways:

a) Convey the object code in, or embodied in, a physical product (including a physical distribution medium), accompanied by the Corresponding Source fixed on a durable physical medium customarily used for software interchange. b) Convey the object code in, or embodied in, a physical product (including a physical distribution medium), accompanied by a written offer, valid for at least three years and valid for as long as you offer spare parts or customer support for that product model, to give anyone who possesses the object code either (1) a copy of the Corresponding Source for all the software in the product that is covered by this License, on a durable physical medium customarily used for software interchange, for a price no more than your reasonable cost of physically performing this conveying of source, or (2) access to copy the Corresponding Source from a network server at no charge. c) Convey individual copies of the object code with a copy of the written offer to provide the Corresponding Source. This alternative is allowed only occasionally and noncommercially, and only if you

received the object code with such an offer, in accord with subsection 6b. d) Convey the object code by offering access from a designated place (gratis or for a charge), and offer equivalent access to the Corresponding Source in the same way through the same place at no further charge. You need not require recipients to copy the Corresponding Source along with the object code. If the place to copy the object code is a network server, the Corresponding Source may be on a different server (operated by you or a third party) that supports equivalent copying facilities, provided you maintain clear directions next to the object code saying where to find the Corresponding Source. Regardless of what server hosts the Corresponding Source, you remain obligated to ensure that it is available for as long as needed to satisfy these requirements. e) Convey the object code using peer-to-peer transmission, provided you inform other peers where the object code and Corresponding Source of the work are being offered to the general public at no charge under subsection 6d.

A separable portion of the object code, whose source code is excluded from the Corresponding Source as a System Library, need not be included in conveying the object code work.

A "User Product" is either (1) a "consumer product", which means any tangible personal property which is normally used for personal, family, or household purposes, or (2) anything designed or sold for incorporation into a dwelling. In determining whether a product is a consumer product, doubtful cases shall be resolved in favor of coverage. For a particular product received by a particular user, "normally used" refers to a typical or common use of that class of product, regardless of the status of the particular user or of the way in which the particular user actually uses, or expects or is expected to use, the product. A product is a consumer product regardless of whether the product has substantial commercial, industrial or non-consumer uses, unless such uses represent the only significant mode of use of the product.

"Installation Information" for a User Product means any methods, procedures, authorization keys, or other information required to install and execute modified versions of a covered work in that User Product from a modified version of its Corresponding Source. The information must suffice to ensure that the continued functioning of the modified object code is in no case prevented or interfered with solely because modification has been made.

If you convey an object code work under this section in, or with, or specifically for use in, a User Product, and the conveying occurs as part of a transaction in which the right of possession and use of the User Product is transferred to the recipient in perpetuity or for a fixed term (regardless of how the transaction is characterized), the Corresponding Source conveyed under this section must be accompanied by the Installation Information. But this requirement does not apply if neither you nor any third party retains the ability to install modified object code on the User Product (for example, the work has been installed in ROM).

The requirement to provide Installation Information does not include a requirement to continue to provide support service, warranty, or updates for a work that has been modified or installed by the recipient, or for the User Product in which it has been modified or installed. Access to a network may be denied when the modification itself materially and adversely affects the operation of the network or violates the rules and protocols for communication across the network.

Corresponding Source conveyed, and Installation Information provided, in accord with this section must be in a format that is publicly documented (and with an implementation available to the public in source code form), and must require no special password or key for unpacking,

reading or copying.

7. Additional Terms.

"Additional permissions" are terms that supplement the terms of this License by making exceptions from one or more of its conditions. Additional permissions that are applicable to the entire Program shall be treated as though they were included in this License, to the extent that they are valid under applicable law. If additional permissions apply only to part of the Program, that part may be used separately under those permissions, but the entire Program remains governed by this License without regard to the additional permissions.

When you convey a copy of a covered work, you may at your option remove any additional permissions from that copy, or from any part of it. (Additional permissions may be written to require their own removal in certain cases when you modify the work.) You may place additional permissions on material, added by you to a covered work, for which you have or can give appropriate copyright permission.

Notwithstanding any other provision of this License, for material you add to a covered work, you may (if authorized by the copyright holders of that material) supplement the terms of this License with terms:

a) Disclaiming warranty or limiting liability differently from the terms of sections 15 and 16 of this License; or b) Requiring preservation of specified reasonable legal notices or author attributions in that material or in the Appropriate Legal Notices displayed by works containing it; or c) Prohibiting misrepresentation of the origin of that material, or requiring that modified versions of such material be marked in reasonable ways as different from the original version; or d) Limiting the use for publicity purposes of names of licensors or authors of the material; or e) Declining to grant rights under trademark law for use of some trade names, trademarks, or service marks; or f) Requiring indemnification of licensors and authors of that material by anyone who conveys the material (or modified versions of it) with contractual assumptions of liability to the recipient, for any liability that these contractual assumptions directly impose on those licensors and authors.

All other non-permissive additional terms are considered "further restrictions" within the meaning of section 10. If the Program as you received it, or any part of it, contains a notice stating that it is governed by this License along with a term that is a further restriction, you may remove that term. If a license document contains a further restriction but permits relicensing or conveying under this License, you may add to a covered work material governed by the terms of that license document, provided that the further restriction does not survive such relicensing or conveying.

If you add terms to a covered work in accord with this section, you must place, in the relevant source files, a statement of the additional terms that apply to those files, or a notice indicating where to find the applicable terms.

Additional terms, permissive or non-permissive, may be stated in the form of a separately written license, or stated as exceptions; the above requirements apply either way.

8. Termination.

You may not propagate or modify a covered work except as expressly provided under this License. Any attempt otherwise to propagate or modify it is void, and will automatically terminate your rights under this License (including any patent licenses granted under the third paragraph of section 11).

However, if you cease all violation of this License, then your license from a particular copyright holder is reinstated (a) provisionally, unless and until the copyright holder explicitly and finally terminates your license, and (b) permanently, if the copyright holder fails to notify you of the violation by some reasonable means prior to 60 days after the cessation.

Moreover, your license from a particular copyright holder is reinstated permanently if the copyright holder notifies you of the violation by some reasonable means, this is the first time you have received notice of violation of this License (for any work) from that copyright holder, and you cure the violation prior to 30 days after your receipt of the notice.

Termination of your rights under this section does not terminate the licenses of parties who have received copies or rights from you under this License. If your rights have been terminated and not permanently reinstated, you do not qualify to receive new licenses for the same material under section 10.

9. Acceptance Not Required for Having Copies.

You are not required to accept this License in order to receive or run a copy of the Program. Ancillary propagation of a covered work occurring solely as a consequence of using peer-to-peer transmission to receive a copy likewise does not require acceptance. However, nothing other than this License grants you permission to propagate or modify any covered work. These actions infringe copyright if you do not accept this License. Therefore, by modifying or propagating a covered work, you indicate your acceptance of this License to do so.

10. Automatic Licensing of Downstream Recipients.

Each time you convey a covered work, the recipient automatically receives a license from the original licensors, to run, modify and propagate that work, subject to this License. You are not responsible for enforcing compliance by third parties with this License.

An "entity transaction" is a transaction transferring control of an organization, or substantially all assets of one, or subdividing an organization, or merging organizations. If propagation of a covered work results from an entity transaction, each party to that transaction who receives a copy of the work also receives whatever licenses to the work the party's predecessor in interest had or could give under the previous paragraph, plus a right to possession of the Corresponding Source of the work from the predecessor in interest, if the predecessor has it or can get it with reasonable efforts.

You may not impose any further restrictions on the exercise of the rights granted or affirmed under this License. For example, you may not impose a license fee, royalty, or other charge for exercise of rights granted under this License, and you may not initiate litigation (including a cross-claim or counterclaim in a lawsuit) alleging that any patent claim is infringed by making, using, selling, offering for sale, or importing the Program or any portion of it.

11. Patents.

A "contributor" is a copyright holder who authorizes use under this License of the Program or a work on which the Program is based. The work thus licensed is called the contributor's "contributor version".

A contributor's "essential patent claims" are all patent claims owned or controlled by the contributor, whether already acquired or hereafter acquired, that would be infringed by some manner, permitted by this License, of making, using, or selling its contributor version, but do

not include claims that would be infringed only as a consequence of further modification of the contributor version. For purposes of this definition, "control" includes the right to grant patent sublicenses in a manner consistent with the requirements of this License.

Each contributor grants you a non-exclusive, worldwide, royalty-free patent license under the contributor's essential patent claims, to make, use, sell, offer for sale, import and otherwise run, modify and propagate the contents of its contributor version.

In the following three paragraphs, a "patent license" is any express agreement or commitment, however denominated, not to enforce a patent (such as an express permission to practice a patent or covenant not to sue for patent infringement). To "grant" such a patent license to a party means to make such an agreement or commitment not to enforce a patent against the party.

If you convey a covered work, knowingly relying on a patent license, and the Corresponding Source of the work is not available for anyone to copy, free of charge and under the terms of this License, through a publicly available network server or other readily accessible means, then you must either (1) cause the Corresponding Source to be so available, or (2) arrange to deprive yourself of the benefit of the patent license for this particular work, or (3) arrange, in a manner consistent with the requirements of this License, to extend the patent license to downstream recipients. "Knowingly relying" means you have actual knowledge that, but for the patent license, your conveying the covered work in a country, or your recipient's use of the covered work in a country, would infringe one or more identifiable patents in that country that you have reason to believe are valid.

If, pursuant to or in connection with a single transaction or arrangement, you convey, or propagate by procuring conveyance of, a covered work, and grant a patent license to some of the parties receiving the covered work authorizing them to use, propagate, modify or convey a specific copy of the covered work, then the patent license you grant is automatically extended to all recipients of the covered work and works based on it.

A patent license is "discriminatory" if it does not include within the scope of its coverage, prohibits the exercise of, or is conditioned on the non-exercise of one or more of the rights that are specifically granted under this License. You may not convey a covered work if you are a party to an arrangement with a third party that is in the business of distributing software, under which you make payment to the third party based on the extent of your activity of conveying the work, and under which the third party grants, to any of the parties who would receive the covered work from you, a discriminatory patent license (a) in connection with copies of the covered work conveyed by you (or copies made from those copies), or (b) primarily for and in connection with specific products or compilations that contain the covered work, unless you entered into that arrangement, or that patent license was granted, prior to 28 March 2007.

Nothing in this License shall be construed as excluding or limiting any implied license or other defenses to infringement that may otherwise be available to you under applicable patent law.

12. No Surrender of Others' Freedom.

If conditions are imposed on you (whether by court order, agreement or otherwise) that contradict the conditions of this License, they do not excuse you from the conditions of this License. If you cannot convey a covered work so as to satisfy simultaneously your obligations under this License and any other pertinent obligations, then as a consequence you may not convey it at

all. For example, if you agree to terms that obligate you to collect a royalty for further conveying from those to whom you convey the Program, the only way you could satisfy both those terms and this License would be to refrain entirely from conveying the Program.

13. Use with the GNU Affero General Public License.

Notwithstanding any other provision of this License, you have permission to link or combine any covered work with a work licensed under version 3 of the GNU Affero General Public License into a single combined work, and to convey the resulting work. The terms of this License will continue to apply to the part which is the covered work, but the special requirements of the GNU Affero General Public License, section 13, concerning interaction through a network will apply to the combination as such.

14. Revised Versions of this License.

The Free Software Foundation may publish revised and/or new versions of the GNU General Public License from time to time. Such new versions will be similar in spirit to the present version, but may differ in detail to address new problems or concerns.

Each version is given a distinguishing version number. If the Program specifies that a certain numbered version of the GNU General Public License "or any later version" applies to it, you have the option of following the terms and conditions either of that numbered version or of any later version published by the Free Software Foundation. If the Program does not specify a version number of the GNU General Public License, you may choose any version ever published by the Free Software Foundation.

If the Program specifies that a proxy can decide which future versions of the GNU General Public License can be used, that proxy's public statement of acceptance of a version permanently authorizes you to choose that version for the Program.

Later license versions may give you additional or different permissions. However, no additional obligations are imposed on any author or copyright holder as a result of your choosing to follow a later version.

15. Disclaimer of Warranty.

THERE IS NO WARRANTY FOR THE PROGRAM, TO THE EXTENT PERMITTED BY APPLICABLE LAW. EXCEPT WHEN OTHERWISE STATED IN WRITING THE COPYRIGHT HOLDERS AND/OR OTHER PARTIES PROVIDE THE PROGRAM "AS IS" WITHOUT WARRANTY OF ANY KIND, EITHER EXPRESSED OR IMPLIED, INCLUDING, BUT NOT LIMITED TO, THE IMPLIED WARRANTIES OF MERCHANTABILITY AND FITNESS FOR A PARTICULAR PURPOSE. THE ENTIRE RISK AS TO THE QUALITY AND PERFORMANCE OF THE PROGRAM IS WITH YOU. SHOULD THE PROGRAM PROVE DEFECTIVE, YOU ASSUME THE COST OF ALL NECESSARY SERVICING, REPAIR OR CORRECTION.

16. Limitation of Liability.

IN NO EVENT UNLESS REQUIRED BY APPLICABLE LAW OR AGREED TO IN WRITING WILL ANY COPYRIGHT HOLDER, OR ANY OTHER PARTY WHO MODIFIES AND/OR CONVEYS THE PROGRAM AS PERMITTED ABOVE, BE LIABLE TO YOU FOR DAMAGES, INCLUDING ANY GENERAL, SPECIAL, INCIDENTAL OR CONSEQUENTIAL DAMAGES ARISING OUT OF THE USE OR INABILITY TO USE THE PROGRAM (INCLUDING BUT NOT LIMITED TO LOSS OF DATA OR DATA BEING RENDERED INACCURATE OR LOSSES SUSTAINED BY YOU OR THIRD PARTIES OR A FAILURE OF THE PROGRAM TO OPERATE WITH ANY OTHER PROGRAMS), EVEN IF SUCH HOLDER OR OTHER PARTY HAS BEEN ADVISED OF THE POSSIBILITY OF SUCH DAMAGES.

17. Interpretation of Sections 15 and 16.

If the disclaimer of warranty and limitation of liability provided above cannot be given local legal effect according to their terms, reviewing courts shall apply local law that most closely approximates an absolute waiver of all civil liability in connection with the Program, unless a warranty or assumption of liability accompanies a copy of the Program in return for a fee.

END OF TERMS AND CONDITIONS

How to Apply These Terms to Your New Programs

If you develop a new program, and you want it to be of the greatest possible use to the public, the best way to achieve this is to make it free software which everyone can redistribute and change under these terms.

To do so, attach the following notices to the program. It is safest to attach them to the start of each source file to most effectively state the exclusion of warranty; and each file should have at least the "copyright" line and a pointer to where the full notice is found.

```
<one line to give the program's name and a brief idea of what it does.>
Copyright (C) <year> <name of author>
```

This program is free software: you can redistribute it and/or modify it under the terms of the GNU General Public License as published by the Free Software Foundation, either version 3 of the License, or (at your option) any later version.

This program is distributed in the hope that it will be useful, but WITHOUT ANY WARRANTY; without even the implied warranty of MERCHANTABILITY or FITNESS FOR A PARTICULAR PURPOSE. See the GNU General Public License for more details.

You should have received a copy of the GNU General Public License along with this program. If not, see <https://www.gnu.org/licenses/>.

Also add information on how to contact you by electronic and paper mail.

If the program does terminal interaction, make it output a short notice like this when it starts in an interactive mode:

```
<program> Copyright (C) <year> <name of author> This program comes with
ABSOLUTELY NO WARRANTY; for details type `show w'. This is free
software, and you are welcome to redistribute it under certain
conditions; type `show c' for details.
```

The hypothetical commands `show w' and `show c' should show the appropriate parts of the General Public License. Of course, your program's commands might be different; for a GUI interface, you would use an "about box".

You should also get your employer (if you work as a programmer) or school, if any, to sign a "copyright disclaimer" for the program, if necessary. For more information on this, and how to apply and follow the GNU GPL, see <https://www.gnu.org/licenses/>.

The GNU General Public License does not permit incorporating your program into proprietary programs. If your program is a subroutine library, you may consider it more useful to permit linking proprietary applications with the library. If this is what you want to do, use the GNU Lesser General Public License instead of this License. But first, please read <https://www.gnu.org/licenses/why-not-lgpl.html>.

Copyright notice see above.

This license document may be reproduced and distributed unchanged, but no modifications are permitted.
Translation: <www-en>, 2011-2014, 2016.

14 APPENDIX: SNMP OID OVERVIEW

This overview is also available with factory settings via the web interface using the URL: <http://192.168.100.1/snmpd.txt>.

```
#
# SNMP command overview for the CyBox AP family (automatically generated)
#
#
# SNMPSET commands:
#
# radio0_up
# radio0_down
# radio1_up
# radio1_down
# modem0_up
# modem1_up
# modem2_up
# modem3_up
# modem4_up
# modem0_down
# modem1_down
# modem2_down
# modem3_down
# modem4_down
# modem0_simslot <value>
# modem1_simslot <value>
# modem2_simslot <value>
# modem3_simslot <value>
# modem4_simslot <value>
# network<index>.<entry> <value>
# radio<index>.<entry> <value>
```

```
# wireless<index>.<entry> <value>

# uci <command> <config>.<section>[.<option>]=<value>

# service <name> <action>

# reboot

#

# SNMPSET system call:

#

# snmpset -c private -v 2c <IPv4> 1.3.6.1.4.1.2021.8.1 s <command string
or set entry string>

#

#

#

# SNMPGET/SNMPWALK objects:

#

# see list below

#

# SNMPGET system call:

#

# snmpget -c public -v 2c <IPv4> 1.3.6.1.4.1.2021.8.1.2.<ID>.101.1

#

# SNMPWALK system call:

#

# snmpwalk -c public -v 2c <IPv4> 1.3.6.1.4.1.2021.8.1.2.<ID>

#

##### system Table0 objects #####

boardname 1.3.6.1.4.1.2021.8.1.2.100

serial_number 1.3.6.1.4.1.2021.8.1.2.101

uboot_version 1.3.6.1.4.1.2021.8.1.2.102

firmware_version 1.3.6.1.4.1.2021.8.1.2.103

config_version 1.3.6.1.4.1.2021.8.1.2.104

uptime 1.3.6.1.4.1.2021.8.1.2.105

loadavg 1.3.6.1.4.1.2021.8.1.2.106

temperature 1.3.6.1.4.1.2021.8.1.2.107

uci_get 1.3.6.1.4.1.2021.8.1.2.108
```

```

custom1 1.3.6.1.4.1.2021.8.1.2.109
custom2 1.3.6.1.4.1.2021.8.1.2.110
custom3 1.3.6.1.4.1.2021.8.1.2.111
mpstat 1.3.6.1.4.1.2021.8.1.2.112

##### system Table0 objects #####

network_order 1.3.6.1.4.1.2021.8.1.2.150

----listing not printed here, see console command on top of this page
for live listing. The editor.----

```

15 APPENDIX: DEFAULT FACTORY SETTINGS

When shipped, the device has the following default settings:

Defaults for Ethernet 1 (all models):

Interface	IPv4 address type	Address	Remark
lan	static IPv4 address	192.168.100.1/24	
lan_alias	static IPv4 address	Calculated based on serial number	See chapter 4.1 IP Addresses of the CyBox GW
lan_dhcp	IPv4 DHCP client		
lan_mac	static IPv4 address	Calculated based on eth0 MAC address	See chapter 4.1 IP Addresses of the CyBox GW

Defaults for Ethernet 2:

Interface	IPv4 address	Address	Remark
wan	IPv4 DHCP client		
wan6	IPv6 DHCP client		

Other Defaults (all models):

Interface	Parameter	Remark
Password for user 'root'	root	Be sure to change it before deployment
WLAN, LTE, GPS	disabled	
Bridge	disabled	
DHCP/DNS server	disabled	
Firewall	'Input' and 'Output' are set to <i>ACCEPT</i> , 'Forward' is set to <i>REJECT</i>	
VLAN	Not configured	

Default Network Configuration

16 APPENDIX: ANTENNA MODULE ASSIGNMENT

This paragraph is for CyBox models with variable radio/modem antenna distribution.

