



Viper 3512-PoE Series

12 port Ethernet M12 switches with Power over Ethernet



Table of Contents

| | |
|--|----|
| 1. General Information | 3 |
| 1.1. Legal Information | 3 |
| 1.2. About This Guide | 3 |
| 1.3. Software Tools | 3 |
| 1.4. License and Copyright for Included FLOSS | 3 |
| 1.5. WeOS | 3 |
| 2. Safety and Regulations | 4 |
| 2.1. Warning Levels | 4 |
| 2.2. Safety Information | 5 |
| 2.3. Care Recommendations | 7 |
| 2.4. Product Disposal | 7 |
| 2.5. Compliance Information | 8 |
| 2.5.1. Agency Approvals and Standards Compliance | 8 |
| 2.5.2. EN/IEC 61010-2-201 Notice | 8 |
| 2.5.3. FCC Part 15.105 Class A Notice | 8 |
| 2.5.4. Simplified Declaration of Conformity | 9 |
| 3. Product Description | 10 |
| 3.1. Product Description | 10 |
| 3.2. Available Models | 10 |
| 3.3. Hardware Overview | 12 |
| 3.4. Connector Pinout | 13 |
| 3.5. LED Indicators | 15 |
| 3.6. Dimensions | 16 |
| 4. Installation | 17 |
| 4.1. Wall Mounting | 17 |
| 4.2. Protective Earth Connection | 17 |
| 4.3. Connection of Cables | 18 |
| 4.4. Cooling | 19 |
| 4.5. Replacement of Product | 19 |
| 4.6. EN 45545-2 Mounting Notes | 19 |
| 5. Specifications | 20 |
| 5.1. Interface Specifications | 20 |
| 5.2. Type Tests and Environmental Conditions | 25 |
| 6. Revision Notes | 27 |

1. General Information

1.1. Legal Information

The contents of this document are provided “as is”. Except as required by applicable law, no warranties of any kind are made in relation to the accuracy and reliability or contents of this document, either expressed or implied, including but not limited to the implied warranties of merchantability and fitness for a particular purpose. Westermo reserves the right to revise this document or withdraw it at any time without prior notice.

Under no circumstances shall Westermo be responsible for any loss of data or income or any special, incidental, and consequential or indirect damages howsoever caused.

More information about Westermo can be found at www.westermo.com.

1.2. About This Guide

This guide is intended for installation engineers and users of the Westermo products.

It includes information on safety and regulations, a product description, installation instructions and technical specifications.

1.3. Software Tools

Related software tools are available at <https://www.westermo.com/support/product-support>.

1.4. License and Copyright for Included FLOSS

This product includes software developed by third parties, including Free/Libre Open Source Software (FLOSS). The specific license terms and copyright associated with the software are included in each software package respectively. Please visit the product web page for more information.

Upon request, the applicable source code will be provided. A nominal fee may be charged to cover shipping and media. Please direct any source code request to your normal sales or support channel.

1.5. WeOS

This product runs WeOS (Westermo Operating System). Instructions for quick start, configuration and factory reset are found in the WeOS user documentation at www.westermo.com.

2. Safety and Regulations

2.1. Warning Levels

Warning signs are provided to prevent personal injuries and/or damages to the product. The following levels are used:





| Level of warning | Description | Consequence personal injury | Consequence material damage |
|---|---|--------------------------------|--------------------------------|
|  WARNING | Indicates a potentially hazardous situation | Possible death or major injury | Major damage to the product |
|  CAUTION | Indicates a potentially hazardous situation | Minor or moderate injury | Moderate damage to the product |
|  NOTICE | Provides information in order to avoid misuse of the product, confusion or misunderstanding | No personal injury | Minor damage to the product |
|  NOTE | Used for highlighting general, but important information | No personal injury | Minor damage to the product |

Table 1. Warning levels

2.2. Safety Information

Before installation:

Read this manual completely and gather all information available on the product. Make sure it is fully understood. Check that your application does not exceed the safe operating specifications for the product.



SAFETY DURING INSTALLATION

The product must be installed and operated by qualified service personnel and installed into an apparatus cabinet or similar, where access is restricted to service personnel only.

Refer to chapter Compliance Information to see the required level of qualified service personnel according to safety standards.

Before energising and connecting communication cables to the product, ensure a protective earthing conductor is first connected to the protective earthing terminal (only valid for metallic housings). Westermo recommends a cross-sectional area of at least 4 mm².

Note that this product can be connected to two different power sources.

Upon removal of the product, disconnect the product from the power supply and all other communication ports before disconnecting the protective earthing conductor.



HAZARDOUS VOLTAGE

Do not open an energised product. Hazardous voltage may occur when connected to a power supply.



PROTECTIVE FUSE

The power supply wiring must be sufficiently fused. The fuse must be IEC 60127 certified and rated for T6A (HV models) or T10A (LV models) and 250 V.

It must be possible to disconnect manually from the power supply. Ensure compliance to national installation regulations.

This product has no internal fuse and should be connected via an external fuse for protection.



REDUCE THE RISK OF FIRE

To reduce the risk of fire, use only telecommunication line cords with a cable diameter of AWG 26 or larger. Regarding power cable dimensions, see chapter Interface Specifications.



CABLE TEMPERATURE RATING FOR FIELD TERMINAL WIRES

There may be a requirement on the minimum temperature rating of the cable to be connected to the field wiring terminals, see chapter Interface Specifications.



ELECTROSTATIC DISCHARGE (ESD)

Prevent electrostatic discharge damage to internal electronic parts by discharging your body to a grounding point (e.g. use a wrist strap).



HOT SURFACE

Be aware that the surface of this product may become hot. When it is operated at high temperatures, the external surface may exceed Touch Temperature Limit according to the product's relevant electrical safety standard.



NOTE - MECHANICAL FORCE ON VENTILATION MEMBRANE

Do not cover or bring mechanical force to the ventilation membrane on the back of the product.



NOTICE - ADDITIONAL EMC TYPETESTS

For additional EMC typetests with powering via a CDN or similar high inductive filters, please contact Westermo for correct test setup.

2.3. Care Recommendations

Follow the care recommendations below to maintain full operation of the product and to fulfill the warranty obligations:

- Do not drop, knock or shake the product. Rough handling above the specification may cause damage to internal circuit boards.
- Use a dry or slightly water-damp cloth to clean the product. Do not use harsh chemicals, cleaning solvents or strong detergents.
- Do not paint the product. Paint can clog the product and prevent proper operation.

If the product is used in a manner not according to specification, the protection provided by the equipment may be impaired.

If the product is not working properly, contact the place of purchase, the nearest Westermo distributor office or Westermo technical support.

2.4. Product Disposal

This symbol means that the product shall not be treated as unsorted municipal waste when disposing of it. It needs to be handed over to an applicable collection point for recycling electrical and electronic equipment.

Proper disposal of the product helps minimize hazardous substances and prevents potential negative impacts on both the environment and human health.



Figure 1. WEEE symbol for treatment of product disposal

2.5. Compliance Information

2.5.1. Agency Approvals and Standards Compliance

| Type | Approval/Compliance |
|------------------------------------|--|
| Climate | <ul style="list-style-type: none"> EN 50155 class OT4 / IEC 60571 class TX, Railway applications - Electronic equipment used on rolling stock IEEE 1478 class 1, condition E4 (incl Salt Mist), Environmental conditions for transit rail car electronic equipment |
| EMC | <ul style="list-style-type: none"> EN/IEC 61000-6-2, Immunity industrial environments EN/IEC 61000-6-4, Emission industrial environments EN 50121-3-2/IEC 62236-3-2 Railway applications - Rolling stock - apparatus Tested and verified for Class S1, DB EMC Regulation 06, Commodity team Radio compatibility in VDB Rev 1.0 (Shunting Radio) Tested and verified for FCC part 15b class A (CFR 47) E-Mark, Road Vehicles, E1 10R-058547^a. |
| Mechanical (Shock and vibration) | <ul style="list-style-type: none"> EN 61373 category 1, class A and B EN 60068-2-27 20 g, 11 ms and 100 g, 6 ms |
| Insulation (Coordination and test) | <ul style="list-style-type: none"> EN 50124-1, Railway applications - Insulation coordination EN 50155/IEC 60571, Railway applications - Electronic equipment used on rolling stock |
| Fire protection | <ul style="list-style-type: none"> EN 45545-2, Fire protection on railway vehicles NFPA 130, Fire protection for fixed guideway transit and passenger rail system |
| Cybersecurity ^b | <ul style="list-style-type: none"> IEC 62443-4-2 SL2, Security for industrial automation and control systems |
| Software | <ul style="list-style-type: none"> EN 50657:2017 Software Onboard Rolling Stock (Basic Integrity) |
| Safety ^c | <ul style="list-style-type: none"> EN/IEC 61010-1, -2-201, Safety requirements for electrical equipment for measurement, control, and laboratory use |

^aApplicable only for Viper-LV models

^bCertification ongoing

^cApplicable only for Viper-HV models

Table 2. Agency approvals and standards compliance

2.5.2. EN/IEC 61010-2-201 Notice

This product has been tested and found compliant to EN/IEC 61010-2-201, Safety requirements for electrical equipment for measurement, control, and laboratory use. In accordance with the definitions of the standard, this product shall be handled by skilled service personnel.

2.5.3. FCC Part 15.105 Class A Notice

This product has been tested and found to comply with the limits for a Class A digital device, pursuant to Part 15 of the FCC Rules.

These limits are designed to provide reasonable protection against harmful interference when the product is operated in a commercial environment.

This product generates, uses, and can radiate radio frequency energy and, if not installed and used in accordance with the user manual, may cause harmful interference to radio communications. Operation of this product in a residential area is likely to cause harmful interference in which case the user will be required to correct the interference at the users own expense.

2.5.4. Simplified Declaration of Conformity

Hereby, Westermo declares that this product is in compliance with applicable EU directives and UK legislations. The full declaration of conformity and other detailed information is available at www.westermo.com/support/product-support.



Figure 2. The European Conformity and the UK Conformity Assessment markings

3. Product Description

3.1. Product Description

The Viper 3512-PoE series consists of managed 12 port routing switches optimised for the needs of the railway rolling stock market. PoE ports offer effective powering of end-devices. Gbps ports cope with high bandwidth devices such as access points and NVRs (Network Video Recorders).

The Viper 3512-PoE series is designed to withstand the tough environment on-board trains, exposing the switch to constant vibration, extreme temperatures, humidity and a demanding electrical environment.

A GORE-TEX® membrane prevents internal condensation. Threading integrated in chassis provides for additional vibration resistance. High-level isolation between all interfaces enables direct connectivity to vehicle auxiliary power and protects against overvoltage and flashover. IP67 protection prevents ingress of water and dust. An overall optimised design results in an extremely compact package in combination with very high MTBF for easy integration and low lifecycle cost.

Thorough type testing at independent ISO/IEC 17025 and ILAC MRA certified labs, accredited to a wide range of standards, show that the Viper series fulfills EN 50155 and other requirements. The state-of-the-art Westermo production facility ensures the quality of each individual unit, e.g. through temperature cycling burn-in testing.

The WeOS operating system offers an extensive suite of IP networking features for resilient and flexible networks, e.g. the FRNT ring protocol with very fast failover. The powerful layer 3 routing capability is very useful for separating networks in complex applications. The backup device accessory matches the Viper in robustness and offers easy configuration update and backup.

Meeting the requirements of the railcar market, the Viper 3512-PoE series is very well suited for deployment in any other application with severe operating conditions and tough environments, for instance in the mining industry.

3.2. Available Models

All switches are managed and have eight PoE ports. Viper 3512-PoE is used when referring to both layer 2 and layer 3 models.

| Art. no. | Model | SW | Gbps ports | HV | LV |
|-----------|-------------------------------|---------|------------|------------|-----------|
| 3635-0115 | Viper-3512-T4-P8-HV | Layer 2 | - | 48 - 110 V | |
| 3635-0415 | Viper-3512-T3G-T1-P8-HV | Layer 2 | 3 | 48 - 110 V | |
| 3635-0715 | Viper-3512-T3G-P2G-T1-P6-HV | Layer 2 | 5 | 48 - 110 V | |
| 3635-0215 | Viper-3512-T4-P8-LV | Layer 2 | - | | 24 - 38 V |
| 3635-0515 | Viper-3512-T3G-T1-P8-LV | Layer 2 | 3 | | 24 - 38 V |
| 3635-0815 | Viper-3512-T3G-P2G-T1-P6-LV | Layer 2 | 5 | | 24 - 38 V |
| 3635-0125 | Viper-3512-E-T4-P8-HV | Layer 3 | - | 48 - 110 V | |
| 3635-0425 | Viper-3512-E-T3G-T1-P8-HV | Layer 3 | 3 | 48 - 110 V | |
| 3635-0725 | Viper-3512-E-T3G-P2G-T1-P6-HV | Layer 3 | 5 | 48 - 110 V | |
| 3635-0225 | Viper-3512-E-T4-P8-LV | Layer 3 | - | | 24 - 38 V |
| 3635-0525 | Viper-3512-E-T3G-T1-P8-LV | Layer 3 | 3 | | 24 - 38 V |
| 3635-0825 | Viper-3512-E-T3G-P2G-T1-P6-LV | Layer 3 | 5 | | 24 - 38 V |

Table 3. Available models

3.3. Hardware Overview

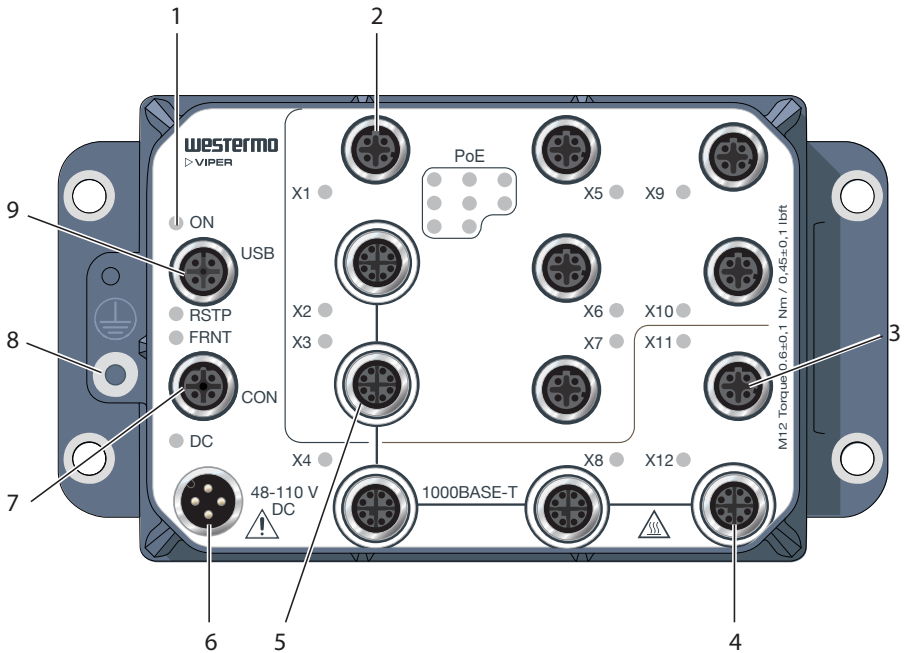

| No. | Description | No. | Description |
|-----|---------------|-----|-----------------------------|
| 1 | LED indicator | 2 | 100 Mbps PoE port |
| 3 | 100 Mbps port | 4 | Gbps port |
| 5 | Gbps PoE port | 6 | Power connection |
| 7 | Console port | 8 | Protective earth connection |
| 9 | USB port | | |

Figure 3. Location of interface ports and LED indicators

3.4. Connector Pinout

| Pin no. | Signal | Illustration |
|---------|--------|--------------|
| 1 | +DC1 | |
| 2 | +DC1 | |
| 3 | -COM | |
| 4 | -COM | |

Table 4. Power connector HV, male, A-coded

| Pin no. | Signal | Illustration |
|---------|--------|--------------|
| 1 | +DC1 | |
| 2 | +DC1 | |
| 3 | -COM | |
| 4 | -COM | |

Table 5. Power connector LV, male, T-coded

The Viper series has single power connection. Dual pins shall be connected to the power supply (+DC1 for positive terminal, -COM for negative terminal) in order to distribute the current over two pins

| Pin no. | Signal | Illustration |
|---------|--------|--------------|
| 1 | NC | |
| 2 | TX | |
| 3 | RX | |
| 4 | NC | |
| 5 | GND | |

Table 6. Console connector, female, B-coded

| Pin no. | Signal | Illustration |
|---------|--------|--------------|
| 1 | DN | |
| 2 | VBUS | |
| 3 | NC | |
| 4 | DC | |
| 5 | GND | |

Table 7. USB connector, female, A-coded

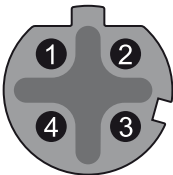
| Pin no. | Signal | Illustration |
|---------|--------|---|
| 1 | TD+ |  |
| 2 | RD+ | |
| 3 | TD- | |
| 4 | RD- | |

MDI, MDI-X and auto MDI/MDI-X modes are supported. The table shows signals in MDI mode.

Table 8. 100 Mbps Ethernet connector, female, D-coded

| Pin no. | Signal | Illustration |
|---------|--------|---|
| 1 | DA+ |  |
| 2 | DA- | |
| 3 | DB+ | |
| 4 | DB- | |
| 5 | DD+ | |
| 6 | DD- | |
| 7 | DC- | |
| 8 | DC+ | |

Table 9. Gbps connector, female, X-coded

3.5. LED Indicators

| LED | Status | Description |
|------------------|-------------|---|
| ON | OFF | Product has no power |
| | GREEN | All OK, no alarm condition |
| | RED | Alarm condition, or until product has started up. (Alarm conditions are configurable, see <i>WeOS4 Management Guide</i>) |
| | BLINK | Location indicator ("Here I am!"). Activated when connected to WeConfig tool, or upon request from web or/and CLI. RED BLINK during boot indicates pending cable factory reset. |
| RSTP | OFF | RSTP disabled |
| | GREEN | RSTP enabled |
| | BLINK | Product selected as RSTP/STP root switch |
| FRNT | OFF | FRNT disabled |
| | GREEN | FRNT OK |
| | RED | FRNT error |
| | FLASH | Product configured as FRNT focal point |
| DC | OFF | Product has no power |
| | GREEN | Power OK. Input voltage > 70% of minimum nominal voltage |
| | RED | Power failure. Input voltage < 70 % of minimum nominal voltage |
| X1 to X12 | OFF | No link |
| | GREEN | Link established |
| | GREEN FLASH | Data traffic indication |
| | YELLOW | Port alarm, or port is set in blocking state by link redundancy protocol |
| PoE | OFF | Port does not consume PoE power |
| | GREEN | Port consumes PoE power |

Table 10. LED indicators

3.6. Dimensions

Dimensions are stated in mm and are regardless of model.

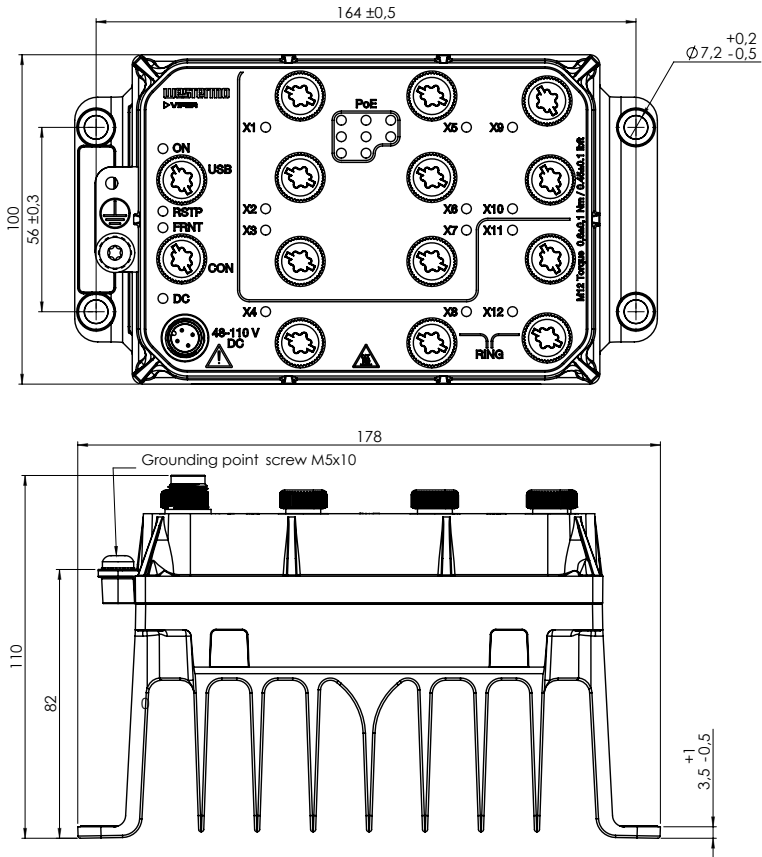

Figure 4. Dimensional drawing

4. Installation

4.1. Wall Mounting

The product can be wall mounted vertically or horizontally. There are four pieces of 7 mm bores for this. Use four M5, M6 or 1/4" screws with 12 mm washers on a flat and stable surface.

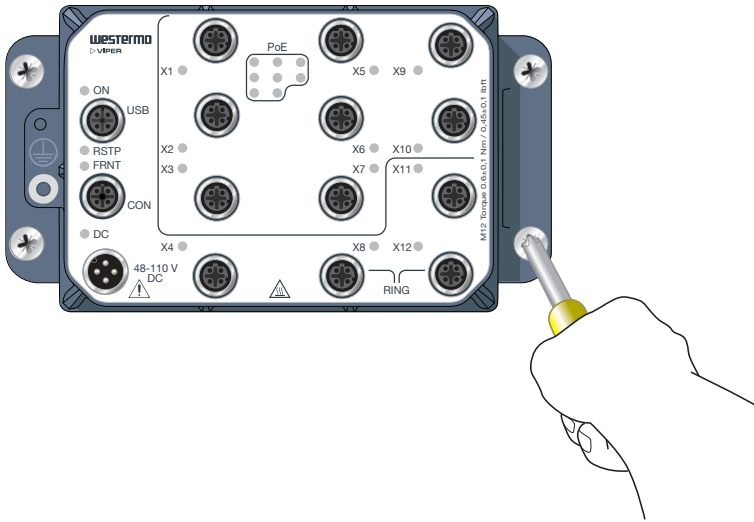

Figure 5. Wall mounting

4.2. Protective Earth Connection

For correct function, the earth connection needs to be properly connected to a designated PE rail. Torx: T25 and torque: 3.2 Nm.

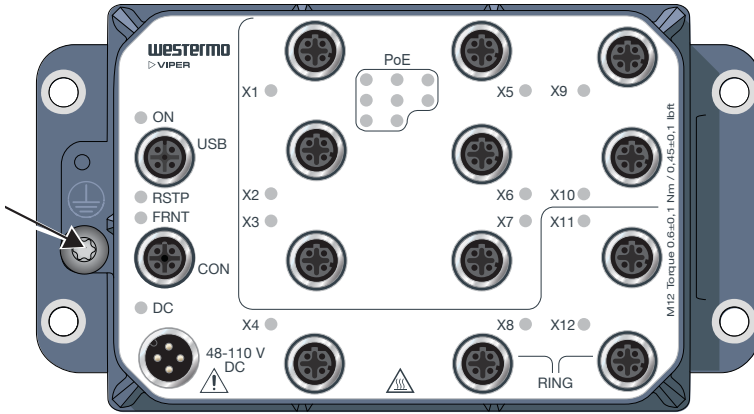

Figure 6. Earth connection

4.3. Connection of Cables

Recommended tightening torque for the M12 connectors is 0.6 Nm. All M12 connections are screw connections.

When connecting the power cable, ensure that the pins are connected correctly before tightening the power cable to the unit.



PROTECTIVE FUSE

The power supply wiring must be sufficiently fused. The fuse must be IEC 60127 certified and rated for T6A (HV models) or T10A (LV models) and 250 V.

It must be possible to disconnect manually from the power supply. Ensure compliance to national installation regulations.

This product has no internal fuse and should be connected via an external fuse for protection.



NOTE - UNUSED CONNECTORS

Unused connectors must be covered by a protective cap (delivered with the product), tightened to the specified torque in order to fulfill the specified ingress protection code.

4.4. Cooling

This product relies on convection cooling. Make sure that it is installed so that the ambient temperature is within the specified temperature range. Avoid obstruction of the airflow around the product.

4.5. Replacement of Product

Disconnect all cables and unscrew the product from the wall. Mount the replacement product and reconnect all cables, observing the instructions in [Connection of Cables \[18\]](#). For easy replication of the configuration of the original product, it is recommended to have the Westermo USB plug permanently connected to the USB port and move it over to the replacement product before it is powered up.

MTTR (Mean Time To Repair), i.e. time for replacement of product is: < 10 minutes.



HOT SURFACE

Be aware that the surface of this product may become hot. When it is operated at high temperatures, the external surface may exceed Touch Temperature Limit according to the product's relevant electrical safety standard.

4.6. EN 45545-2 Mounting Notes

Two product can be mounted together and as a single interior non-listed group in the sense of EN 45545-2 definitions. For multiple product, the spacing requirements for interior non-listed groups must be met.

5. Specifications

5.1. Interface Specifications

| DC, Power port | |
|---------------------------------------|--|
| Rated voltage^a. | Viper-LV units: 24 to 38 VDC Viper-HV units: 48 to 110 VDC |
| Operating voltage^b. | Viper-LV units: 16.8 to 49.9 VDC (14.4 VDC for 100 ms and 53.2 VDC for 1 s) Viper-HV units: 33.6 to 143 VDC (28.8 VDC for 100 ms and 154 VDC for 1 s) |
| Rated current | Viper-LV units: max 4.6 A at 24 VDC, max 2.9 A at 38 VDC Viper-HV units: max 2.4 A at 48 VDC, max 1.0 A at 110 VDC |
| Rated frequency | DC |
| Inrush current | Viper-LV units: 540 mA ² s at 24 VDC, 410 mA ² s at 38 V Viper-HV units: 190 mA ² s at 48 VDC, 160 mA ² s at 110 V |
| Startup current | Viper-LV units: 1.5 A at 16.8 VDC Viper-HV units: 750 mA at 33.6 VDC |
| Polarity | Reverse polarity protected |
| Redundant power input | No |
| Isolation | 2250 VDC to all other ports |
| Circuit type | Secondary circuit hazardous voltage, OVC II |
| Connector | Viper-LV units: 4-pin, male, M12, T-coded, recommended Westermo cable: 3146-1109 for 5 m Viper-HV units: 4-pin, male, M12, A-coded, recommended Westermo cables: 3146-1106 for 1.5 m, 3146-1107 for 5 m 3146-1107 for 5 m |
| Cable size | For Viper-HV units: M12, recommended power cable area 0.5 mm ² (minimum 0.25 mm ²), which correlates to AWG 21 or larger For Viper-LV units: M12, recommended power cable area 1 mm ² (minimum 0.75 mm ²), which correlates to AWG 18 or larger Cable dimensions depend on choice of M12 connector |
| Cable temperature rating | For minimum temperature rating of the cable to be connected to the field wiring terminals: -40 to +70 °C |

^aAlso referred to as nominal voltage in EN/IEC 61010-1

^bAlso referred to as nominal voltage in EN/IEC/UL 61010-1

| 100 Mbps ports, non-PoE^a | |
|--|---|
| Electrical specification | IEEE std 802.3 |
| Data rate | 10 Mbps, 100 Mbps, manual or auto |
| Duplex | Full or half, manual or auto |
| Circuit type | TNV-1 |
| Transmission range | Up to 150 m with CAT5e cable or better |
| Isolation | To all other ports |
| Connector | 4-pin, female, M12, D-coded, auto MDI/MDI-X, recommended Westermo cables: 3146-1100 M12-M12 - 1 m 3146-1101 M12-M12 - 5 m 3146-1103 RJ45-M12 - 1 m 3146-1104 RJ45-M12 - 5 m |
| Shielded cable | Shielded cable CAT5e or better is recommended |
| Conductive chassis | Yes |
| FRNT reconfiguration time | Typically below 20 ms |

^a100 Mbps ports, non-PoE, are:

X4, X8, X11-X12 on Viper-3512(-E)-T4-P8-HV/LV

X11 on Viper-3512(-E)-T3G-T1-P8-HV/LV and Viper-3512(-E)-T3G-P2G-T1-P6-HV/LV

| Gbps ports, non-PoE^a | |
|--|---|
| Electrical specification | IEEE std 802.3 |
| Data rate | 10 Mbps, 100 Mbps, 1000 Mbps, manual or auto |
| Circuit type | TNV-1 |
| Duplex | Full or half, manual or auto |
| Transmission range | Up to 100 m with CAT5e cable or better |
| Isolation | To all other ports |
| Connector | 8-pin, female, M12, X-coded |
| Shielded cable | Shielded cable CAT5e or better is recommended |
| Conductive chassis | Yes |
| FRNT reconfiguration time | Typically below 20 ms |

^aGbps ports, non-PoE are: X4, X8, X12 on Viper-3512(-E)-T3G-T1-P8-HV/LV and Viper-3512(-E)-T3G-P2G-T1-P6-HV/LV

| PoE ports, 100 Mbps^a | |
|--|---|
| Electrical specification | IEEE std 802.3 |
| Data rate | 10 Mbps, 100 Mbps, manual or auto |
| Circuit type | TNV-1 |
| Transmission range | Up to 100 m with CAT5e cable or better |
| Isolation | To all other ports |
| Output voltage | 54 VDC, ±5% |
| Output power^b | Max 30 W on one port (PoE+) Max 80 W in total on all ports |
| Data rate | 10 Mbps, 100 Mbps, manual or auto |
| Duplex | Full or half, manual or auto |
| Connector | 4-pin, female, M12, D-coded, auto MDI/MDI-X, recommended Westermo cables: 3146-1100 M12-M12 - 1 m 3146-1101 M12-M12 - 5 m 3146-1103 RJ45-M12 - 1 m 3146-1104 RJ45-M12 - 5 m |
| Shielded cable | Shielded cable CAT5e or better is recommended |
| Conductive chassis | Yes |
| FRNT reconfiguration time | Typically below 20 ms |

^aPoE ports are: X1-X3, X5-X7, X9-X10. X2 and X3 are Gbps for Viper-3512(-E)-T3G-P2G-T1-P6-LV/HV

^bAs delivered by Power Sourcing Equipment, i.e. the Viper 3512-PoE switch. Power available at Powered Device is depending on the cable resistance.

| PoE ports, Gbps ^a . | |
|----------------------------------|---|
| Electrical specification | IEEE std 802.3 |
| Data rate | 10 Mbps, 100 Mbps, 1000 Mbps, manual or auto |
| Circuit type | TNV-1 |
| Transmission range | Up to 100 m with CAT5e cable or better |
| Isolation | To all other ports |
| Output voltage | 54 VDC, ±5% |
| Output power^b. | Max 30 W on one port (PoE+) Max 80 W in total on all ports |
| Duplex | Full or half, manual or auto |
| Connector | 8-pin, female, M12, X-coded |
| Shielded cable | Shielded cable CAT5e or better is recommended |
| Conductive chassis | Yes |
| FRNT reconfiguration time | Typically below 20 ms |

^aPoE ports are: X1-X3, X5-X7, X9-X10. X2 and X3 are Gbps for Viper-3512(-E)-T3G-P2G-T1-P6-LV/HV

^bAs delivered by Power Sourcing Equipment, i.e. the Viper 3512-PoE switch. Power available at Powered Device is depending on the cable resistance.



NOTE

PoE ports are not isolated from each other.

| USB port | |
|---------------------------------|---|
| Electrical specification | USB 2.0 host interface |
| Data rate | Up to 480 Mbps (high-speed mode) |
| Maximum supply current | 200 mA |
| Circuit type | SELV |
| Isolation | To all Ethernet and DC ports No isolation to CON or protective earth |
| Connector | 5-pin, female, M12, A-coded, recommended Westermo USB plug 3641-0190 |

| Console port | |
|---------------------------------|---|
| Electrical specification | RS-232 |
| Data rate | 115.2 kbit/s |
| Data format | 8 data bits, no parity, 1 stop bit, no flow control |
| Circuit type | SELV |
| Isolation | To all Ethernet and DC ports No isolation to USB or protective earth |
| Connector | 5-pin, female, M12, B-coded, recommended Westermo cables: 1211-2215 (serial port) or 1211-4073 (USB) |

5.2. Type Tests and Environmental Conditions

| Environmental phenomena | Basic standard | Description | Test levels |
|------------------------------|--------------------------|---|--|
| ESD | EN 61000-4-2 | Enclosure | Contact: ± 6 kV Air: ± 8 kV |
| Fast transients | EN 61000-4-4 | Power port | ± 2 kV |
| | | Signal ports | |
| | | Earth port | |
| Surge | EN 61000-4-5 | Power port | L-E: ± 2 kV, 42Ω , $0.5 \mu\text{F}$, $1.2/50 \mu\text{s}$ L-E: ± 1 kV, 12Ω , $9 \mu\text{F}$, $1.2/50 \mu\text{s}$ L-L: ± 2 kV, 42Ω , $0.5 \mu\text{F}$, $1.2/50 \mu\text{s}$ L-L: ± 0.5 kV, 2Ω , $18 \mu\text{F}$, $1.2/50 \mu\text{s}$ |
| | | Ethernet port | L-E: ± 2 kV, 2Ω |
| Pulsed magnetic field | EN 61000-4-9 | Enclosure | 300 A/m |
| Radiated RF immunity | EN 61000-4-3 | Enclosure | 20 V/m at (80 MHz to 2 GHz) 10 V/m at (2-6 GHz) 1 kHz sine, 80% AM |
| Conducted RF immunity | EN 61000-4-6 | Power port | 10 V, 80% AM, 1 kHz; (0.15-80) MHz |
| | | Ethernet ports | |
| | | Earth port | |
| Radiated RF emission | CISPR 16-2-3 | Enclosure | EN 61000-6-4 (80-6000 MHz) |
| | ANSI C63,4 (FCC Part 15) | | EN 61000-6-4 (80-6500 MHz) |
| Conducted RF emission | CISPR 16-2-1 | Power port | EN 61000-6-4 |
| | | Ethernet ports | EN 61000-6-3 |
| Dielectric strength | EN 50155 | Power port to all other ports | 2250 VDC, 1 min |
| | | Ethernet ports to all other ports | 2250 VDC, 1 min |
| | | Gbps Ethernet ports to all other ports | 2250 VDC, 1 min ^a |
| | | PoE ports to all other ports ^b | 2250 VDC, 1 min ^a |

^a.750 VDC after damp heat, according to EN 50155

^b.PoE ports are not isolated to each other, except on a functional level.

Table 11. EMC and electrical conditions

| Environmental phenomena | Basic standard | Description | Test levels |
|-----------------------------|---|--------------------------------------|--|
| Temperatures | EN 60068-2-1 | Operational | -40 to +70°C (-40 to +158°F) ^{a,b.} |
| | EN 60068-2-2 | Storage and transport | -55 to +85°C (-67 to +185°F) |
| Humidity | EN 60068-2-30 | Operational | 5-95% relative humidity |
| | | Storage and transport | |
| Altitude | | Operational | 2000 m/80 kPa |
| Service life | | Operational | 20 years according to IEC/TR 62380 |
| MTBF | 1: MIL-HDBK-217F2, GB, 25°C (+77°F) 2: IEC 62380 | | 1: 400,000 h 2: 471,000 h |
| Vibration | IEC 60068-2-6 (sine) | Operational | 2 g rms 5-500 Hz, 5 sweeps |
| | IEC 60068-2-64 (random) | Non-operational long life simulation | 11.44 m/s ² rms 5-150 Hz, 5 hours |
| Shock | IEC 60068-2-27 | Operational | 10 g, 30 ms, half sine 20 g, 11 ms, saw tooth 100 g, 6 ms, half sine |
| Weight | | | 1.6 kg |
| Degree of protection | EN 60529 | Enclosure | IP67 |
| Cooling | | | Convection |
| Overvoltage category | EN/IEC 61010-1 | | OVC II |
| Pollution degree | EN/IEC 61010-1 | | PD3 macro environment and PD2 micro environment ^{c.} |
| | EN 50124-1 | | PD2 |
| Location | EN/IEC 61010-1 | | Outdoor, wet locations |
| | IEEE 1478 | | Class 1, condition E4. Indoor |

^aRefer to "Safety and Regulations" chapter regarding touch temperature

^bOperational at +85°C for a limited time

^cInstallation and maintenance shall be made under controlled environments.

Table 12. Environmental and mechanical conditions

6. Revision Notes

| Revision | Date | Change description |
|-----------------|-------------|---------------------------|
| Rev. A | 2024-10 | First version |

