





## **General information**

### **Legal information**

The contents of this document are provided “as is”. Except as required by applicable law, no warranties of any kind, either express or implied, including, but not limited to, the implied warranties of merchantability and fitness for a particular purpose, are made in relation to the accuracy and reliability or contents of this document. Westermo reserves the right to revise this document or withdraw it at any time without prior notice.

Under no circumstances shall Westermo be responsible for any loss of data or income or any special, incidental, and consequential or indirect damages howsoever caused.

More information about Westermo can be found at the following Internet address:  
[www.westermo.com](http://www.westermo.com)

## Safety information



### **Before installation:**

Read this manual completely and gather all information on the unit. Make sure that you understand it fully. Check that your application does not exceed the safe operating specifications for this unit.

The unit must be installed by a service person and connected to a protective earthing contact. Disconnect all telecommunication network connectors and cable distribution system connectors before disconnecting the protective earthing contacts.

This unit should be built-in to an apparatus cabinet, or similar, where access is restricted to service personnel only.

The power supply wiring must be sufficiently fused, and if necessary it must be possible to disconnect manually from the power supply. Ensure compliance to national installation regulations.

This unit uses convection cooling. To avoid obstructing the airflow around the unit, follow the spacing recommendations (see Cooling section).

This unit uses negative earth, therefore the 0V and protective earth must be connected to ensure robust functionality.



### **Before mounting, using or removing this unit:**

Prevent access to hazardous voltage by disconnecting the unit from power supply. Warning! Do not open connected unit. Hazardous voltage may occur within this unit when connected to power supply.

## Care recommendations

Follow the care recommendations below to maintain full operation of unit and to fulfil the warranty obligations.

This unit must not be operating with removed covers or lids. Do not attempt to disassemble the unit. There are no user serviceable parts inside. Do not drop, knock or shake the unit, rough handling above the specification may cause damage to internal circuit boards. Do not use harsh chemicals, cleaning solvents or strong detergents to clean the unit. Do not paint the unit. Paint can clog the unit and prevent proper operation. Do not expose the unit to any kind of liquids (rain, beverages, etc). The unit is not waterproof. Keep the unit within the specified humidity levels. Do not use or store the unit in dusty, dirty areas, connectors as well as other mechanical parts may be damaged.

If the unit is not working properly, contact the place of purchase, nearest Westermo distributor office or Westermo Tech support.

### **Maintenance**

No maintenance is required, as long as the unit is used as intended within the specified conditions.

## Product disposal



This symbol means that the product shall not be treated as unsorted municipal waste when disposing of it. It needs to be handed over to an applicable collection point for recycling electrical and electronic equipment.

By ensuring this product is disposed of correctly, you will help to reduce hazardous substances and prevent potential negative consequences to both environment and human health, which could be caused by inappropriate disposal.

## Simplified EU declaration of conformity

Hereby, Westermo declares that the equipment is in compliance with applicable EU directives. The full EU declaration of conformity and other detailed information are available at the respective product page at [www.westermo.com](http://www.westermo.com).

## Agency approvals and standards compliance

Type	Approval / Compliance
EMC	EN 61000-6-1, Immunity residential environments
	EN 61000-6-2, Immunity industrial environments
	EN 61000-6-3, Emission residential environments
	EN 61000-6-4, Emission industrial environments
Safety	EN 60950-1, IT equipment

## Type tests and environmental conditions

Phenomena	Test	Description	Test levels
ESD	EN 61000-4-2	Enclosure contact	± 6 kV (crit A)
		Enclosure air	± 8 kV (crit A)
Radiated RF immunity	IEC 61000-4-3	Enclosure	20 V/m (crit A) (80 – 2700 MHz)
Fast transient	EN 61000-4-4	DC power ports	± 2 kV (crit A)
		Ethernet ports	± 2 kV (crit A)
		Serial port	± 2 kV (crit B)
		xDSL ports	± 2 kV (crit B)
Surge	EN 61000-4-5	DC power ports	± 2 kV (crit A), 42 Ω ± 500 V (crit A), 12 Ω
		Ethernet ports	± 2 kV (crit A), (shielded cable)
		xDSL ports	± 2 kV (crit B)
RF conducted	EN 61000-4-6	DC power ports	10 V/m, (crit A), (0.15 – 80 MHz)
		Ethernet ports	3 V/m, (crit A), (0.15 – 80 MHz) 10 V/m, (crit B), (0.15 – 80 MHz)
		xDSL ports	3 V/m (crit A), (0.15 – 80 MHz) 10 V/m (crit B), (0.15 – 80 MHz)
Radiated emission	CISPR 16-2-3	Enclosure	EN 61000-6-3
Conducted emission	CISPR 16-2-1	DC power ports	EN 61000-6-3
	CISPR 32	Ethernet ports	
		xDSL port	
Temperature	EN 60068-2-1	Operating	-25 to +70°C (-13 to +158°F)
	EN 60068-2-2	Storage & Transport	-40 to +85°C (-40 to +185°F)
Humidity	EN 60068-2-30	Operating	0 to 90% relative humidity non condensing.
		Storage & Transport	0 to 90% relative humidity non condensing.
Altitude		Operating	2000 m / 70 kPa
Service life		Operating	10 year
Dimension W x H x D			53 x 103 x 97 mm (2.08 x 4.05 x 3.81 in)
Weight			0.40 kg
Degree of protection	IEC 529	Enclosure	IP 40
Cooling			Convection
Mounting			Horizontal on 35 mm DIN-rail

## Description

Remote access removes boundaries, eliminates the need for time consuming site visits and provides a network infrastructure suitable for today's "always-on" society. The BRD-355 is an industrially designed xDSL (ADSL/VDSL2) broadband router built to cope with harsh environments and the characteristics of industrial applications. The unit supports a wide range of xDSL-standards and has support for long lines.

Most devices today comes equipped with an Ethernet port for communications, therefore the BRD-355 has a built-in two port Ethernet switch. For legacy connectivity the unit also features one RS-232-port to provide multiple connection possibilities for both new and legacy replacement installations. Designed to be installed on a DIN-rail all connectors and LEDs have been positioned in the front of the unit, facing the user for easy access and fast status feedback. With wide power input range, the unit can be powered from 10 to 60VDC and has low power consumption.

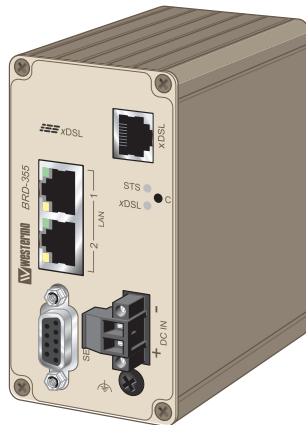

The cyber security features of the BRD-355 prevent unauthorized access and secure the communication for Internet-enabled applications. The easy to use firewall filters incoming traffic, allowing only approved packets to pass through. To inter-connect units with each other securely over the Internet multiple VPN technologies are supported, including IPsec and OpenVPN.

Upgrading legacy solutions to become IP-enabled can prove both costly and tedious therefore the BRD-355 includes a wide feature set for various legacy applications including both modem replacement methods as well as serial to Ethernet conversion. If there are applications that require extra attention Westernmo's extensive experience from over 35 years within industrial data communications and over 5 years of industrial xDSL expertise will be available to assist you.



## Interface specifications

<b>Power</b>	
Rated voltage	12 – 48 VDC
Operating voltage	10 – 60 VDC
Operational current (max)	450 mA @ 12 VDC
Rated current (max)	1000 mA @ 12 VDC
Rated frequency	DC
<b>RS-232</b>	
Electrical specification	EIA RS-232
Data rate	300 bit/s – 115.2 kbit/s
Data format	7 or 8 data bits, Odd, even or none parity, 1 or 2 stop bits
Protocol	Transparent, optimised by packing algorithm
Circuit type	SELV
Transmission range	15 m / 49 ft
Connection	9 pin D-sub female
Shielded cable	Not required
Conductive housing	Yes
Number of ports	1
<b>Ethernet TX</b>	
Electrical specification	IEEE std 802.3. 2005 Edition
Data rate	10 Mbit/s, 100 Mbit/s, manual or auto
Duplex	Full or half, manual or auto
Circuit type	SELV
Transmission range	100 m / 328 ft
Isolation to	All other
Connection	RJ-45 auto MDI/MDIX
Shielded cable	Not required
Conductive housing	Yes
Number of ports	2

<b>DSL</b>				
Protocol	LLC/VC-MUX encap Ethernet, PPPoA, PPPoE, IPoA			
Connection	1 x RJ-11			
<b>Version</b>	<b>Common name</b>	<b>Standard</b>	<b>Downlink</b>	<b>Uplink</b>
ADSL	ADSL	ANSI T1.413	8 Mbit/s	1.0 Mbit/s
	ADSL (G.dmt)	ITU G.992.1	8 Mbit/s	1.0 Mbit/s
	ADSL (G.lite)	ITU G.992.2	1.5 Mbit/s	0.5 Mbit/s
	ADSL over POTS	ITU G.992.1 Annex A	12 Mbit/s	1.3 Mbit/s
	ADSL over ISDN	ITU G.992.1 Annex B	12 Mbit/s	1.8 Mbit/s
ADSL2	RE-ADSL	ITU G.992.3 Annex L1/L2	5 Mbit/s	0.8 Mbit/s
	ADSL2	ITU G.992.3	12 Mbit/s	1.3 Mbit/s
	ADSL2 Annex J	ITU G.992.3 Annex J	12 Mbit/s	3.5 Mbit/s
ADSL2+	ADSL2+	ITU G.992.5	24 Mbit/s	1.4 Mbit/s
	ADSL2+ Annex M	ITU G.992.5 Annex M	24 Mbit/s	3.3 Mbit/s
VDSL2	VDSL2	ITU G.993.2*	100 Mbit/s**	100 Mbit/s**
	VDSL2 Vectoring	ITU G.993.5 G.Vector	100 Mbit/s**	100 Mbit/s**

\* Supports profiles 8a, 8b, 8c, 8d, 12a, 12b, 17a, 30a.

\*\* Maximum sustained routing performance over time is around 35 Mbit/s.

# Connections

## Ethernet TX Connections (RJ-45 connector) LAN1-2

Position	Direction	Description
1	In/Out	TD+
2	In/Out	TD-
3	In/Out	RD+
4	-	Not Connected
5	-	Not Connected
6	In/Out	RD-
7	-	Not Connected
8	-	Not Connected

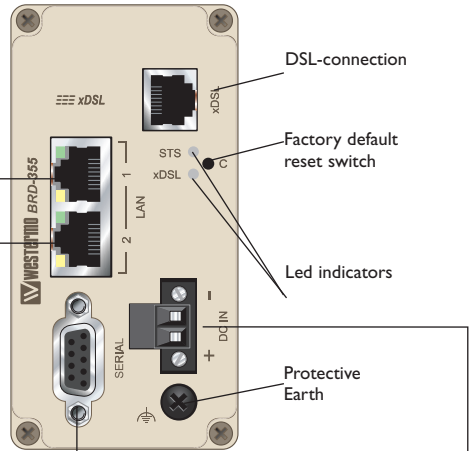

## Router Serial Port (DCE Female)

Position	Name	Direction	Description
1	DCD	Out	Data Carrier Detect
2	RxD	Out	Receive Data
3	TxD	In	Transmit Data
4	DTR	In	Data Terminal Ready
5	SG	-	Signal Ground
6	DSR	Out	Data Set Ready
7	RTS	IN	Request to Send
8	CTS	Out	Clear to Send
9	RI	Out	Ring Indicator

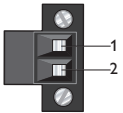

## Power connector

	2-position	Product marking	Direction	Description
	No. 1	-	Input	Common
No. 2	+	Input	Supply voltage input DC	

## LED Indicators

LED	Status	Description	
STS Status	RED	Indicates a fault, except during boot-up	STS ●
	RED FLASH	Indicates a fault, except during boot-up	
	GREEN	All OK	
	GREEN & ONE RED FLASH	All OK but no VPN peer connected	
xDSL Link status	OFF	No ADSL connection	xDSL ●
	GREEN FLASH	Negotiating with the provider DSLAM	
	GREEN	All OK, ADSL link established	

### STS LED – Status indicator

The status indicator reports the health of the unit. In normal operation the indicator will be green, however, if a fault is detected, either at boot-up or during normal operation, the indicator will light red. When the unit is first switched on or is reset, the indicator will first light red then flash red. This is normal behavior during boot-up and does not indicate a fault.

Configuring a VPN connection in the BRD-355 and activating the service will cause the STS LED to be lit GREEN but FLASH RED every third (3) second to indicate that no peer is connected on the VPN. The feature of the VPN status in the STS LED makes it easy for staff to see whether or not the VPN connection is working without having to login to the device.

### DSL LED – xDSL link status

The DSL LED reports the status of the connection to the network. When powered up the indicator will be off, the indicator will then flash green whilst the unit tries to negotiate the link with the provider DSLAM, once successfully connected to the provider the indicator will light green to indicate that everything is ready and functioning on the xDSL link level.

## Factory Default Reset Switch

The reset switch is used to restore the configuration of the BRD-355 to the factory default settings (for details about the default settings see the Getting started section). The switch is accessed through a small hole, adjacent to the xDSL and STS LEDs, labeled C on the front of the unit.

### To reset the configuration:

- Power down the unit.
- Using a suitable tool depress the reset switch.
- Power up the unit ensuring the switch remains depressed for approximately 5 seconds after power is applied. The STS LED will flash twice to indicate a reset.
- Once the unit has booted-up it will use the default settings.

**Note:** Using the factory default reset switch will erase all existing configuration settings and restore the factory default settings.

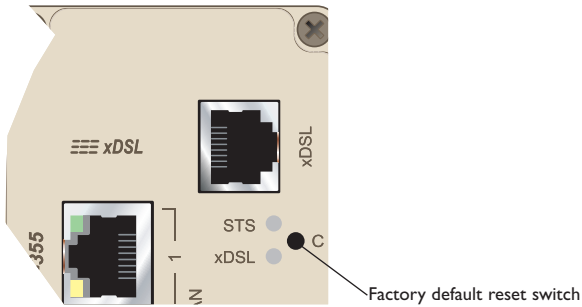

## Protocols and Functionality

Ethernet Technologies	<p>IEEE 802.3 for 10BaseT          IEEE 802.3u for 100BaseTX          Layer-2 QoS          IEEE 802.1p Class of Service</p>
xDSL Technologies	<p>RFC2684 Bridged LLC and Bridged VC-MUX ATM encap. (ADSL)          TR-067 Compliance          Dying Gasp support          ITU K.21 Support          Rate adaptive modem at 32 Kbps steps          ATM Layer with traffic shaping QoS support (UBR, CBR, VBR-rt, VBR-nrt)          AAL5 – AAL          F5 OAM Loopback/Send and receive          RFC2364 PPPoA client support          RFC2516 PPPoE client support          RFC2225 / RFC1577 Classical IP Support          PAP/CHAP/MS-CHAP for Password Authentication support</p>
Serial Port Technologies	<p>RS-232          Serial Over IP (Serial Extender and Virtual Serial Port)          Modem emulation          AT command interpreter          MODBUS          DNP3</p>
IP Routing, Firewall, VPN and Cyber Security	<p>Static IP routing          Dynamic IP routing          • RIPv1/v2          VRRP          GRE          Stateful inspection Firewall / ACL, NAT, Port Forwarding          25 x IPsec VPN, PSK &amp; X.509          1 x L2TP client          1 x PPTP client          1 x OpenVPN / SSL VPN client          RADIUS          PPP Dial in/Dial out</p>
Manageability	<p>Management tools          • Web-interface (HTTP and HTTPS)          • Command Line Interface (CLI) via SSHv2 and TELNET          • SNMPv1/v2c/v3          Syslog (log files)          SNTP (NTP client)          DHCP client          DHCP server          DDNS (Dynamic DNS update client)</p>

For more information on the features and functionality, please refer to the Management Guide on the product website.

## Getting started

### Power Supply

The BRD-355 requires a DC power source in the voltage range of 10 to 60 VDC. The unit is designed to self protect from permanent damage if the voltage exceeds 60 VDC or if reverse polarity is applied. The router may need to be returned for service if this occurs. The router can also be damaged if there is any potential difference between the chassis-ground, RS-232 signal ground or power (-) input. Before connecting any wiring, ensure all components are earthed to a common ground point. An external isolator will be required if a positive earth power supply is used.

### Ethernet

The Ethernet ports are on the front of the unit and are marked LAN 1 and LAN 2, each port has a LED indicating the connection speed and a LED indicating activity as shown in figure below. Both ports are capable of auto-negotiation, meaning cross-over cables are not required. The Ethernet ports are switched, allowing more than one Ethernet device to be connected to the unit at one time.

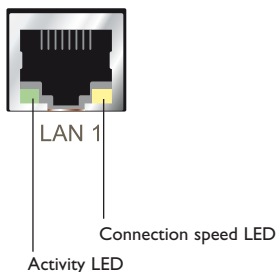

# Configuration

## Accessing and Using the Web Interface

All configuration of the BRD can be done via the web interface. In order to view the web pages a computer with a fixed IP address, on the same sub-net as the BRD, will need to be connected to one of the LAN ports.

The default IP settings of the BRD are:

- IP Address: 192.168.2.200
- Netmask: 255.255.255.0

The recommended IP settings for the PC used to configure the BRD Router:

- IP Address: 192.168.2.100
- Netmask: 255.255.255.0
- Default Gateway: 192.168.2.200
- Primary DNS: 192.168.2.200

**Note:** Although it is possible to connect the BRD directly to a Local Area Network (LAN) it is recommend that the network configuration as described in this section is performed prior to doing so. The DHCP server of the unit is by default disabled.

## Accessing the BRD

- Open a web browser on the PC and browse to <http://192.168.2.200> (the default MRD, IP address) .
- A login box will popup. If the box fails to display, re-check the cable connections to the unit and the IP address settings of the PC.

Enter the following login details:

- User Name: **admin**
- Password: **westermo**



- The Status summary page will be displayed, it will be similar to Figure 3.

**Figure 3**

Status	System	Wireless	Network	Routing	Firewall	VPN	Serial Server
Alarms	Wireless	LAN	VPN	Serial Server	System Log		
Logged in as admin Host: MRD-310-60-00-01							
<b>Alarms</b>							
10:00:28 30/09/2008							
System							
Power On Self Test							Passed
Temperature (°C)	now: 38.00, min: 38.00, max: 38.25						
Uptime	00:03:52						
Wireless							
Network Status							Fault
Connection Status							Fault
Network							
LAN							No Fault
Services							
DHCP Server							Disabled
VPN							Disabled
Serial Server							No Fault

**Note:** If the unit is not yet configured it is likely that the Network Status and Connection Status will indicate a fault condition. This is normal.

## Mounting

This unit should be mounted on 35 mm DIN-rail, which is horizontally mounted inside an apparatus cabinet or similar. Snap on mounting, see figure.

Mounting the BRD-355 with integrated DIN-clip:

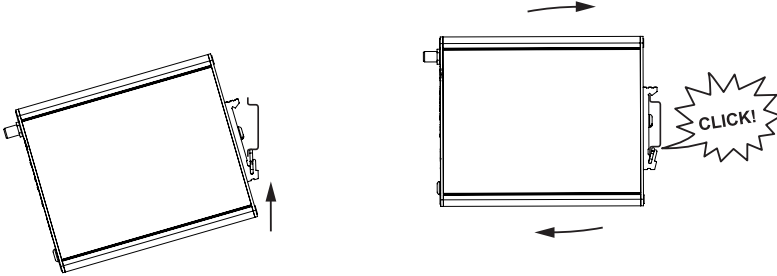

## Cooling

The router should be mounted in a clean and dry location, protected from water, excessive dust, corrosive fumes, extremes of temperature and direct sunlight. Allow sufficient ventilation to ensure adequate cooling of the router.

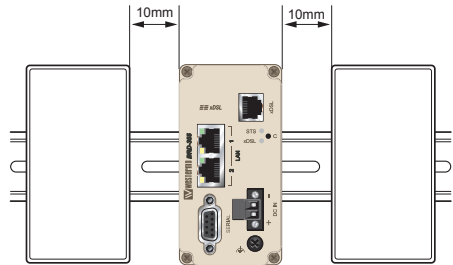

# Dimensional drawing

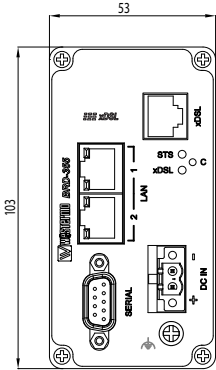
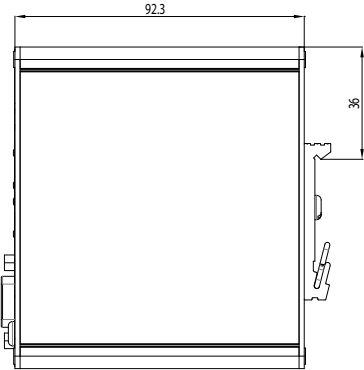

(mm)

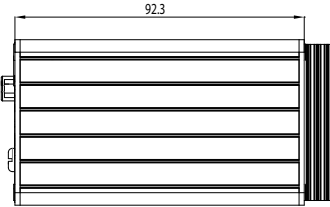



Westermo • SE-640 40 Stora Sundby, Sweden  
Tel +46 16 42 80 00 Fax +46 16 42 80 01  
E-mail: [info@westermo.com](mailto:info@westermo.com)  
[www.westermo.com](http://www.westermo.com)