



SDW-500

SDW-541-F1G-T4G & SDW-550-T5G

Industrial Ethernet 5-port Switch

General information

Legal information

The contents of this document are provided “as is”. Except as required by applicable law, no warranties of any kind, either express or implied, including, but not limited to, the implied warranties of merchantability and fitness for a particular purpose, are made in relation to the accuracy and reliability or contents of this document. Westermo reserves the right to revise this document or withdraw it at any time without prior notice.

Under no circumstances shall Westermo be responsible for any loss of data or income or any special, incidental, and consequential or indirect damages howsoever caused.

More information about Westermo can be found at www.westermo.com

About This Guide





This guide is intended for installation engineers and users of the Westermo products.

It includes information on safety and regulations, a product description, installation instructions and technical specifications.

Safety and Regulations

Warning signs are provided to prevent personal injuries and/or damages to the product.

The following levels are used:

Level of warning	Description	Consequence personal injury	Consequence material damage
 WARNING	Indicates a potentially hazardous situation	Possible death or major injury	Major damage to the product
 CAUTION	Indicates a potentially hazardous situation	Minor or moderate injury	Moderate damage to the product
 NOTICE	Provides information in order to avoid misuse of the product, confusion or misunderstanding	No personal injury	Minor damage to the product
 NOTE	Used for highlighting general, but important information	No personal injury	Minor damage to the product

Safety Information

Before installation:

Read this manual completely and gather all information on the product. Make sure that you understand it fully. Check that your application does not exceed the safe operating specifications for this product.



SAFETY DURING INSTALLATION

The product must be installed and operated by qualified service personnel and installed into an apparatus cabinet or similar, where access is restricted to service personnel only.

Before energising and connecting communication cables to the product, ensure a protective earthing conductor is first connected to the protective earthing terminal (only valid for metallic housings). Westermo recommends a cross-sectional area of at least 4 mm².

If the product does not have a protective earthing terminal, then the DIN-rail must be connected to protective earth. Upon removal of the product, ensure that the protective earthing conductor, or the connection to earth via the DIN-rail, is disconnected last.



HAZARDOUS VOLTAGE

Do not open an energized product. Hazardous voltage may occur when connected to a power supply.



PROTECTIVE FUSE

The power supply wiring must be sufficiently fused. It must be possible to disconnect manually from the power supply. Ensure compliance to national installation regulations.

Replacing the internal fuse must only be performed by Westermo qualified personell.



REDUCE THE RISK OF FIRE

To reduce the risk of fire, use only telecommunication line cords with a cable diameter of AWG 26 or larger. Regarding power cable dimensions, see Interface Specifications.



CLASS 1 LASER PRODUCT

Do not look directly into a fibre optical port or any connected fibre, although the product is designed to meet the Class 1 Laser regulations and complies with 21 CFR 1040.10 and 1040.11.



FIBRE OPTIC HANDLING

Fibre optic equipment need special treatment. It is very sensitive to dust and dirt. If the fibre is disconnected from the product, the protective plugs on the transmitter/receiver must be connected. The protective plugs must be kept on during transportation. The fibre optics cables must be handled the same way.



CORROSIVE GASES

If the product is placed in a corrosive environment, it is important that all unused connector sockets are protected with a suitable plug, in order to avoid corrosion attacks on the gold plated connector pins.



ELECTROSTATIC DISCHARGE (ESD)

Prevent electrostatic discharge damages to internal electronic parts by discharging your body to a grounding point (e.g. use a wrist strap).

Care recommendations

Follow the care recommendations below to maintain full operation of product and to fulfil the warranty obligations:

- Do not drop, knock or shake the product. Rough handling above the specification may cause damage to internal circuit boards.
- Use a dry or slightly water-damp cloth to clean the product. Do not use harsh chemicals, cleaning solvents or strong detergents.
- Do not paint the product. Paint can clog the product and prevent proper operation.

If the product is used in a manner not according to specification, the protection provided by the equipment may be impaired.

If the product is not working properly, contact the place of purchase, nearest Westermo distributor office or Westermo technical support.

Cleaning of the optical connectors

In the event of contamination, the optical connectors should be cleaned by the use of forced nitrogen and some kind of cleaning stick.

Recommended cleaning fluids:

- Methyl-, ethyl-, isopropyl- or isobutyl-alcohol
- Hexane
- Naphtha

Product disposal

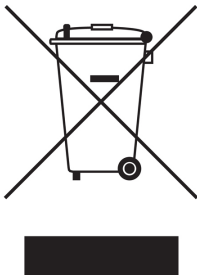

This symbol means that the product shall not be treated as unsorted municipal waste when disposing of it. It needs to be handed over to an applicable collection point for recycling electrical and electronic equipment.

By ensuring the product is disposed of correctly, you will help to reduce hazardous substances and prevent potential negative consequences to both environment and human health, which could be caused by inappropriate disposal.

Simplified EU declaration of conformity

Hereby, Westermo declares that this product is in compliance with applicable EU directives and UK legislations. The full declaration of conformity and other detailed information is available at www.westermo.com/support/product-support.



Agency approvals and standards compliance

Type	Approval / Compliance
EMC	EN 50121-4, Railway applications – Electromagnetic compatibility – Emission and immunity of the signalling and telecommunications apparatus
	EN 61000-6-1, Immunity residential environments
	EN 61000-6-2, Immunity industrial environments
	EN 61000-6-4, Emission industrial environments
Safety	UL 60950-1, IT-equipment
Marine	DNV GL rules for classification – Ships and offshore units
Environmental	NEMA TS 2-2003

DNV GL rules for classification

Type	Temperature	Humidity	Vibration	EMC	Enclosure
SDW-541-F1G-T4G SDW-550-T5G	D	B	B	B	A/IP21

Corrosive environment:

This product has been successfully tested in a corrosion test according to *IEC 60068-2-60, method 3*. This means that the product meets the requirements to be placed in an environment classified as *ISA-S71.04 class G3 and G4*.



CORROSIVE GASES

If the product is placed in a corrosive environment, it is important that all unused connector sockets are protected with a suitable plug, in order to avoid corrosion attacks on the gold plated connector pins.

Type tests and environmental conditions

Environmental phenomena	Basic standard	Description	Test levels
ESD	EN 61000-4-2	Enclosure	Contact: ± 6 kV Air: ± 8 kV
Fast transients	EN 61000-4-4	Power port	± 2 kV
		Signal ports	± 2 kV
Surge	EN 61000-4-5	Power port	Line to earth: ± 2 kV Line to line: ± 1 kV
		Signal ports	Line to earth: ± 2 kV Line to line: ± 1 kV
Power frequency magnetic field	EN 61000-4-8	Enclosure	300 A/m; 0, 16.7, 50 Hz
Pulsed magnetic field	EN 61000-4-9	Enclosure	300 A/m
Radiated RF immunity	EN 61000-4-3	Enclosure	20 V/m @ (80 – 2700) MHz 10 V/m @ (2700 – 6000) MHz 1 kHz sine, 80% AM
Conducted RF immunity	EN 61000-4-6	Power port	10 V, 80% AM, 1 kHz; (0.15 – 80) MHz
		Signal ports	10 V, 80% AM, 1 kHz; (0.15 – 80) MHz
Radiated RF emission	CISPR 16-2-3	Enclosure	Class B (30 – 6000 MHz)
	ANSI C63.4 (FCC Part 15)		Class B (30 – 6500 MHz)
Conducted RF emission	CISPR 16-2-1	Power port	Class B
		Signal ports	Class B
Dielectric strength	UL 60950-1	Power interface to all other	1.5kV AC @ 60s duration
		TX signal interface to all other	1.5kV AC @ 60s duration
		TX shield interface to all other	1.5kV AC @ 60s duration
Environmental			
Temperatures	EN 60068-2-1 EN 60068-2-2	Operating	-40 to +74 °C (-40 to +165 °F)
		Storage and transport	-50 to +85 °C (-58 to +185 °F)
Relative humidity	EN 60068-2-30	Operating	5 to 95 % (non-condensing)
		Storage and transport	5 to 95 % (condensation allowed outside packaging)
Altitude		Operating	2 000 m/70 kPa
Service life		Operating	10 year
Reliability prediction (MTBF)	MIL-HDBK-217F-N2	Operating	SDW-541-F1G-T4G: 1.182.000 hours SDW-550-T5G: 1.121.000 hours
Vibration	IEC 60068-2-6 (sine)	Operating	5–9 Hz ± 6 mm 9–500 Hz ± 2 g
Shock	IEC 60068-2-27	Operating	15 g, 11 ms
Mechanical			
Enclosure	UL94	Plastic	Flammability Class V-0
Dimension W x H x D			34 x 123 x 121 mm
Weight			0.2 kg
Mounting		DIN-rail	
Degree of protection	EN 60529	Enclosure	IP21
Cooling			Convection

Configuration

Auto configured (auto-negotiation) or manually setting of speed and duplex of individual TX port, by DIP-switches. Port mirror function is possible to set with DIP-switch. With the port mirror function active the switch will copy all outgoing traffic to port 1. This can be used to monitor all traffic going out from the switch. Packets may be discarded if the total throughput exceeds the port speed of port 1.

Description

The SDW-541-F1G-T4G is an unmanaged 5-port switch with one SFP fibre port supporting 100 Mbit/s or Gbit Ethernet, and four copper ports supporting 10/100 Mbit/s or Gbit Ethernet. The Westermo range of 100 Mbit or Gbit Small Form-factor Pluggable (SFP) transceivers are available as multimode, singlemode or Bi-Di transceivers with distance up to 120 km.

The SDW-550-T5G is an unmanaged 5-port switch with five copper ports, all supporting 10 Mbit/s, 100 Mbit/s or Gbit Ethernet. Both are designed for easy use in heavy duty industrial, maritime and rail trackside applications. The units support 802.1Q long packets which allow all standard industrial Ethernet protocols to be used.

The units are designed for use in industrial applications with dual 9.6 to 57.6 VDC power input. The unique “tri-galvanic” isolation provides isolation between all ports, power supply and between each chassis screen avoiding ground loop currents. The IP21 rating ensures that the unit can be installed in locations where condensed water may occur. Only industrial grade components are used which gives an MTBF of 1.182.000 hours for the SDW-541-F1T4G and 1.121.000 hours for the SDW-550-T5G and thus ensures a long service life. A wide operating temperature range of -40 to +74 °C (-40 to +165 °F) can be achieved with no moving parts.

The units have been tested both by Westermo and external test houses to meet EMC, isolation, vibration and shock standards, all to the highest levels suitable for heavy industrial, trackside and maritime environments.

Network diagnostics are simplified with the inclusion of port mirroring on one port allowing data flow through the switch to be monitored using a network analyzer. All five ports can have data rate and flow control locked by DIP switch which can eliminate problems with old legacy Ethernet equipment that is unable to support auto negotiation.



Interface specifications

Power	
Operating voltage	Rated: 12 to 48 VDC Operating: 9.6 to 57.6 VDC
Rated current	SDW-541-F1G-T4G: 12-48 VDC; 260–65mA SDW-550-T5G: 12-48 VDC; 260–65mA
Rated frequency	DC
Inrush current, I _{2t}	22.7·10 ⁻³ A ² s @ 48 VDC
Startup current*	2 x Rated current
Polarity	Reverse polarity protected
Redundant power input	Yes
Isolation to	All other
Connection	Detachable screw terminal
Connector size	0.2 – 2.5 mm ² (AWG 24 – 12)
Shielded cable	Not required

* External supply current capability for proper start-up

Ethernet TX	
Electrical specification	IEEE std 802.3. 2005 Edition
Data rate	10 Mbit/s, 100 Mbit/s, 1000 Mbit/s manual or auto
Duplex	Full or half, manual or auto
Circuit type	TNV-1
Transmission range	Up to 150 m with CAT5e cable or better*
Isolation to	All other
Connection	RJ-45, auto MDI/MDI-X
Shielded cable	Not required, except when installed in Railway applications as signalling and telecommunications apparatus and located close to rails.**
Conductive housing	Yes
Number of ports	SDW-541-F1G-T4G: 4 SDW-550-T5G: 5

* Refer to Safety section.

** To minimise the risk of interference, a shielded cable is recommended when the cable is located inside 3 m boundary or the cable is longer than 30 m and inside 10 m boundary to the rails and connected to this port.

Ethernet SFP pluggable connections (FX or TX) (SDW-541-F1G-T4G)	
Electrical specification	IEEE std 802.3. 2005 Edition
Data rate	100 Mbit/s or 1000 Mbit/s transceivers supported
Duplex	Full or Auto, depending on transceiver
Transmission range	Depending on transceiver
Connection	SFP slot holding fibre transceiver or copper transceiver
Number of ports	SDW-541-F1G-T4G: 1

Connections

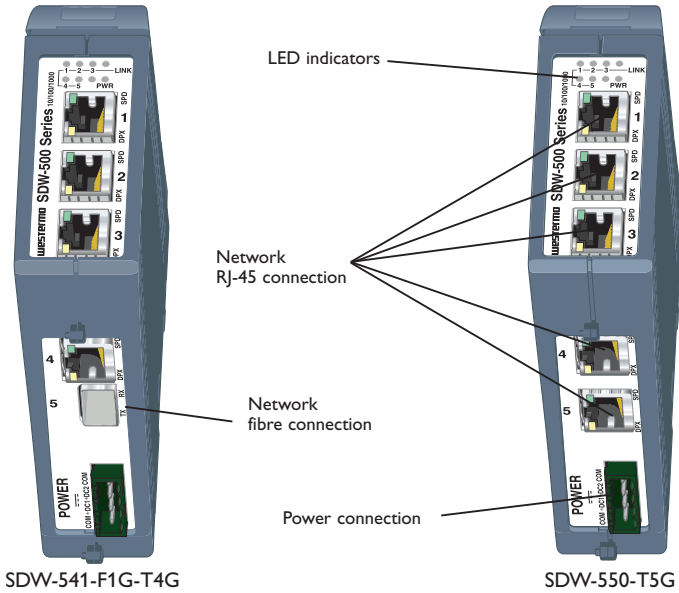

Available models:

- ⌘ SDW-541-F1G-T4G 10/100/1000Base-T/TX: 4 ports, 100/1000Base-FX: 1 port
- ⌘ SDW-550-T5G 10/100/1000Base-T/TX: 5 ports

Power

The SDW-500 series supports redundant power connection. The positive inputs are +DC1 and +DC2, the negative inputs for both supplies are COM. The power is drawn from the input with the highest voltage.

4-pos screw terminal	Description	Power
1	COM	0 V
2	+DC1	9.6–57.6 VDC
3	+DC2	9.6–57.6 VDC
4	COM	0 V

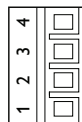

TX

Ethernet TX connection (RJ-45 connector), automatic MDI/MDI-X crossover.

Contact	Direction	Description/Remark
1	In/Out	BI_DA+
2	In/Out	BI_DA-
3	In/Out	BI_DB+
4	In/Out	BI_DC+
5	In/Out	BI_DC-
6	In/Out	BI_DB-
7	In/Out	BI_DD+
8	In/Out	BI_DD-
Shield	In/Out	Connected to PE



CAT 5 cable is recommended.

Unshielded (UTP) or shielded (STP) connector might be used.

F1G, 1 SFP slot

The F1G interface has one SFP slot supporting Ethernet 100/1000 BaseFX/X. Each slot can hold one SFP transceiver for copper or fibre cable.

LED indicators

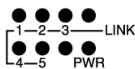

Indicators (LED)

Power (PWR)

Link (LINK) of every port

Speed (SPD) and duplex (DPX) of TX ports

LED	Status	Description
PWR	ON	Internal power, initialising OK
	Slow flash	Initialisation progressing
	Fast flash	Initialisation error
LINK/SPD	OFF	No Ethernet link
	ON	Good Ethernet link
	Flash	Ethernet data is transmitted or received, traffic indication
	Flash 3 Hz	10 Mbit/s
	Flash 6 Hz	100 Mbit/s
	Flash 12 Hz	1000 Mbit/s
DPX	OFF	Half duplex
(TX only)	ON	Full duplex

Installation

Mounting / Removal



HAZARDOUS VOLTAGE

Do not open an energized product. Hazardous voltage may occur when connected to a power supply.



ELECTROSTATIC DISCHARGE (ESD)

Prevent electrostatic discharge damages to internal electronic parts by discharging your body to a grounding point (e.g. use a wrist strap).

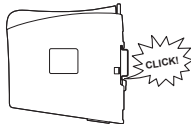
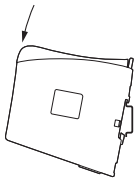

Mounting

This product should be mounted on 35 mm DIN-rail which is horizontally mounted on a wall or cabinet backplate.

Cooling

This unit uses convection cooling. To avoid obstructing the airflow around the unit, use the following spacing rules. Minimum spacing 25 mm (1.0 inch) above / below and 10 mm (0.4 inches) left / right the unit. Spacing is recommended for the use of unit in full operating temperature range and service life.

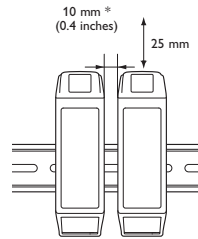

* Spacing (left/right) recommended for full operating temperature range

Removal Press down the black support at the back of the product, see figure.

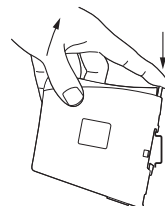

DIP switch settings

DIP-switches are accessible under the lid on top of the unit. DIP-switches are used to configure the unit.



HAZARDOUS VOLTAGE

Do not open an energized product. Hazardous voltage may occur when connected to a power supply.



ELECTROSTATIC DISCHARGE (ESD)

Prevent electrostatic discharge damages to internal electronic parts by discharging your body to a grounding point (e.g. use a wrist strap).

NOTE

When configuration via DIP-switches, the settings of DIP-switches configure the unit only after a reboot (power off/on).

Observe this when the DIP-switches are configured

- ⌘ Speed and duplex setting only valid when auto-negotiation is disabled.
- ⌘ When monitoring selected all outgoing packets from the switch is also copied to the port 1.
- ⌘ Speed and duplex switch settings are ignored for FX ports.
- ⌘ If auto-negotiation and auto MDI/MDI-X disabled all TX ports support MDI-X configuration.
- ⌘ If Hub mode is selected, all incoming and outgoing packets are distributed on all other ports.

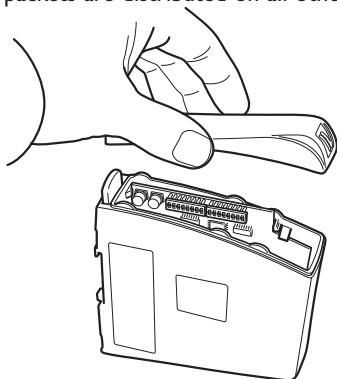





ONLY VALID FOR SDW-541-F1G-T4G:



- ⌘ Speed and duplex switch settings are ignored for FX ports.
- ⌘ If auto-negotiation and auto MDI/MDI-X disabled all TX ports support MDI-X configuration.



Port settings



Port 1 settings

S1   Auto-negotiation enabled
10/100/1000 Mbit/s speed selected



S1   100 Mbit/s speed selected



S1   10 Mbit/s speed selected



S1   Full duplex selected



S1   Half duplex selected



Port 2 settings

S1   Auto-negotiation enabled
10/100/1000 Mbit/s speed selected



S1   100 Mbit/s speed selected



S1   10 Mbit/s speed selected



S1   Full duplex selected



S1   Half duplex selected



Port 3 settings

S1   Auto-negotiation enabled
10/100/1000 Mbit/s speed selected



S1   100 Mbit/s speed selected



S1   10 Mbit/s speed selected



S1   Full duplex selected



S1   Half duplex selected



Port 4 settings

S1   Auto-negotiation enabled
10/100/1000 Mbit/s speed selected

S1   100 Mbit/s speed selected



S2   10 Mbit/s speed selected



S1   Full duplex selected



S2   Half duplex selected



Port 5 settings below only valid for SDW-541-F1G-T4G

Port 5 settings

S2   1000 Mbit/s speed selected



S2   100 Mbit/s speed selected



S2   Full duplex selected.
Note: Only valid for TX SFP



S2   Half duplex selected.
Note: Only valid for TX SFP

Port 5 settings below only valid for SDW-550-T5G



Port 5 settings

S2   Auto-negotiation enabled
10/100/1000 Mbit/s speed selected

S2   100 Mbit/s speed selected

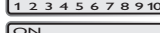
S2   10 Mbit/s speed selected

S2   Full duplex selected

S2   Half duplex selected

Factory settings



Port mirroring settings

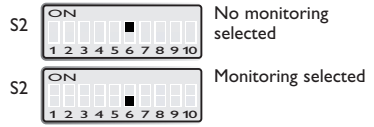

Hub mode

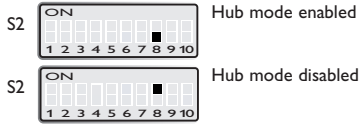

Flow control selected

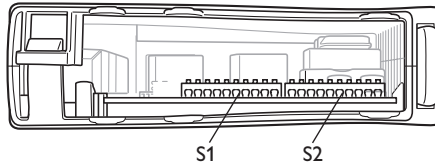
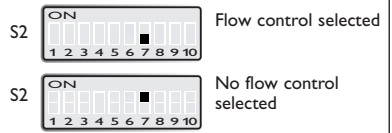

WESTERMO

Westermo • Metallverksgatan 6, SE-721 30 Västerås, Sweden

Tel +46 16 42 80 00 Fax +46 16 42 80 01

E-mail: info@westermo.com

www.westermo.com