



ODW-700 Series

Fibre Optic Modems

Table of Contents

| | |
|---|----|
| 1. General Information | 4 |
| 1.1. Legal Information | 4 |
| 1.2. About This Guide | 4 |
| 2. Safety and Regulations | 5 |
| 2.1. Warning Levels | 5 |
| 2.2. Safety Information | 6 |
| 2.3. Care Recommendations | 7 |
| 2.4. Product Disposal | 8 |
| 2.5. Compliance Information | 8 |
| 2.5.1. Agency Approvals and Standards Compliance | 8 |
| 2.5.2. FCC Part 15.105 Class A Notice | 8 |
| 2.5.3. Simplified Declaration of Conformity | 9 |
| 3. Product Description | 10 |
| 3.1. Product Description | 10 |
| 3.2. Available models | 10 |
| 3.3. Hardware Overview | 11 |
| 3.4. Connector Information | 11 |
| 3.4.1. Power Screw Terminal | 11 |
| 3.4.2. Status Screw Terminal | 12 |
| 3.4.3. PROFIBUS DP (ODW-710) | 13 |
| 3.4.4. RS-232 (ODW-720) | 13 |
| 3.4.5. RS-422/485 Screw Terminal (ODW-730) | 14 |
| 3.4.6. Optical fibre | 14 |
| 3.4.6.1. SFP Transceivers | 14 |
| 3.5. Functional Description | 15 |
| 3.5.1. Converter PROFIBUS DP - Optical Fibre | 15 |
| 3.5.2. Converter Serial Interface - Optical Fibre | 16 |
| 3.5.3. Repeater - Optical Fibre Links | 18 |
| 3.6. LED Indicators | 19 |
| 3.7. Dimensions | 20 |
| 4. Installation | 21 |
| 4.1. Mounting | 21 |
| 4.2. Removal of Product | 21 |
| 4.3. Cooling | 21 |
| 4.4. Settings and Configuration | 22 |
| 4.4.1. ODW-710 models | 22 |
| 4.4.1.1. DIP-Switch Settings, ODW-710 Models | 23 |
| 4.4.1.2. Configuration ODW-710-F1 | 26 |
| 4.4.1.3. Configuration ODW-710-F2 | 29 |
| 4.4.1.4. Start-up Guide ODW-710-F1 | 33 |
| 4.4.1.5. Prepare the Fibre Optical Network | 33 |
| 4.4.2. ODW-720 models | 34 |
| 4.4.2.1. DIP-Switch Settings, ODW-720 Models | 34 |
| 4.4.2.2. Start-up Guide ODW-720-F1, Point-to-Point Application .. | 39 |
| 4.4.2.3. Referring Documents, ODW-720-F2 | 39 |

| | |
|--|----|
| 4.4.3. ODW-730 models | 40 |
| 4.4.3.1. DIP-Switch Settings, ODW-730 Models | 40 |
| 4.4.3.2. Start-up Guide ODW-730-F1, Point-to-Point Application . | 45 |
| 4.4.3.3. ODW-730, RS-485 termination at system level | 46 |
| 4.4.3.4. Referring Documents, ODW-730-F2 | 46 |
| 5. Specifications | 48 |
| 5.1. Interface Specifications | 48 |
| 5.2. Type Tests and Environmental Conditions | 52 |
| 6. Revision Notes | 54 |

1. General Information

1.1. Legal Information

The contents of this document are provided “as is”. Except as required by applicable law, no warranties of any kind are made in relation to the accuracy and reliability or contents of this document, either expressed or implied, including but not limited to the implied warranties of merchantability and fitness for a particular purpose. Westermo reserves the right to revise this document or withdraw it at any time without prior notice.

Under no circumstances shall Westermo be responsible for any loss of data or income or any special, incidental, and consequential or indirect damages howsoever caused.

More information about Westermo can be found at www.westermo.com.

1.2. About This Guide

This guide is intended for installation engineers and users of the Westermo products.

It includes information on safety and regulations, a product description, installation instructions and technical specifications.

2. Safety and Regulations

2.1. Warning Levels

Warning signs are provided to prevent personal injuries and/or damages to the product. The following levels are used:





| Level of warning | Description | Consequence personal injury | Consequence material damage |
|---|---|--------------------------------|--------------------------------|
|  WARNING | Indicates a potentially hazardous situation | Possible death or major injury | Major damage to the product |
|  CAUTION | Indicates a potentially hazardous situation | Minor or moderate injury | Moderate damage to the product |
|  NOTICE | Provides information in order to avoid misuse of the product, confusion or misunderstanding | No personal injury | Minor damage to the product |
|  NOTE | Used for highlighting general, but important information | No personal injury | Minor damage to the product |

Table 1. Warning levels

2.2. Safety Information

Before installation:

Read this manual completely and gather all information available on the product. Make sure it is fully understood. Check that your application does not exceed the safe operating specifications for the product.



SAFETY DURING INSTALLATION

The product must be installed and operated by qualified service personnel and installed into an apparatus cabinet or similar, where access is restricted to service personnel only.

Before energising and connecting communication cables to the product, ensure a protective earthing conductor is first connected to the protective earthing terminal (only valid for metallic housings). Westermo recommends a cross-sectional area of at least 4 mm².

If the product does not have a protective earthing terminal, then the DIN-rail must be connected to protective earth.

Upon removal of the product, disconnect the product from the power supply and all other communication ports before disconnecting the protective earthing conductor, or the connection to earth via the DIN-rail.



HAZARDOUS VOLTAGE

Do not open an energised product. Hazardous voltage may occur when connected to a power supply.



PROTECTIVE FUSE

Branch circuit protection (fuse) is required for this unit with rating not exceeding 20 A. Product should be connected to UL listed power supplies rated 12 - 48 VDC, min 500 mA or 24 VAC, min 500 mA or reliably grounded DC SELV source.

It must be possible to disconnect manually from the power supply. Ensure compliance to national installation regulations.

Replacing the internal fuse must only be performed by Westermo qualified personnel.



CLASS 1 LASER PRODUCT

Do not look directly into a fibre optical port or any connected fibre.



ELECTROSTATIC DISCHARGE (ESD)

Prevent electrostatic discharge damage to internal electronic parts by discharging your body to a grounding point (e.g. use a wrist strap).



HANDLING OF SFP TRANSCEIVERS

SFP transceivers are supplied with plugs to avoid contamination inside the optical port. They are very sensitive to dust and dirt. If the fibre optic cable is disconnected from the product, a protective plug must be used on the transmitter/receiver. The protective plug must be kept on during transportation. The fibre optic cable must be handled the same way.

2.3. Care Recommendations

Follow the care recommendations below to maintain full operation of the product and to fulfill the warranty obligations:

- Do not drop, knock or shake the product. Rough handling above the specification may cause damage to internal circuit boards.
- Use a dry or slightly water-damp cloth to clean the product. Do not use harsh chemicals, cleaning solvents or strong detergents.
- Do not paint the product. Paint can clog the product and prevent proper operation.

If the product is used in a manner not according to specification, the protection provided by the equipment may be impaired.

If the product is not working properly, contact the place of purchase, the nearest Westermo distributor office or Westermo technical support.

2.4. Product Disposal

This symbol means that the product shall not be treated as unsorted municipal waste when disposing of it. It needs to be handed over to an applicable collection point for recycling electrical and electronic equipment.

Proper disposal of the product helps minimize hazardous substances and prevents potential negative impacts on both the environment and human health.



Figure 1. WEEE symbol for treatment of product disposal

2.5. Compliance Information

2.5.1. Agency Approvals and Standards Compliance

| Type | Approval/Compliance |
|---------------|---|
| EMC | <ul style="list-style-type: none">• EN 50121-4/IEC 62236-4, Railway signalling and telecommunications apparatus• EN/IEC 61000-6-1, Immunity residential environments• EN/IEC 61000-6-2, Immunity industrial environments• EN/IEC 61000-6-3, Emission residential environments• EN/IEC 61000-6-4, Emission industrial environments |
| Safety | <ul style="list-style-type: none">• UL/CSA 60950-1, IT equipment |
| Marine | <ul style="list-style-type: none">• DNV rules for classification - Ships and offshore units |

Table 2. Agency approvals and standards compliance

2.5.2. FCC Part 15.105 Class A Notice

This product has been tested and found to comply with the limits for a Class A digital device, pursuant to Part 15 of the FCC Rules.

These limits are designed to provide reasonable protection against harmful interference when the product is operated in a commercial environment.

This product generates, uses, and can radiate radio frequency energy and, if not installed and used in accordance with the user manual, may cause harmful interference to radio communications. Operation of this product in a residential area is likely to cause harmful interference in which case the user will be required to correct the interference at the users own expense.

2.5.3. Simplified Declaration of Conformity

Hereby, Westermo declares that this product is in compliance with applicable EU directives and UK legislations. The full declaration of conformity and other detailed information is available at www.westermo.com/support/product-support.



Figure 2. The European Conformity and the UK Conformity Assessment markings

3. Product Description

3.1. Product Description

The ODW-700 series has been designed to allow PROFIBUS DP, RS-232 or RS-422/485 data to be transmitted over fibre optic links in point-to-point, multidrop or redundant ring networks. The design allows the use of a range of Westermo verified SFP (Small Form Pluggable) transceivers which can provide solutions with, for example, only a single fibre or distances up to 120 km.

The units have been designed for industrial use where the requirement is for a long and reliable service life in a harsh environment. To ensure this reliable operation, it is manufactured using the highest quality components.

The ODW-710 can be used on all PROFIBUS DP networks to extend the operational network size beyond the normal constraints of the copper cable. All the data rates defined in EN 50170 are supported.

The ODW-720 and ODW-730 draws on Westermo's many years of knowledge of serial protocols, with the ODW-720 being able to transmit RS-232 serial data, even the RTS/CTS hardware controls if required. The ODW-730 supports RS-422/485 and can be used on both synchronous and asynchronous data streams, with switch selectable termination circuits that save the need for external terminating resistors.

The F1 variants are excellent for cost effectively creating point-to-point networks with their single fibre port. Meanwhile, the F2 variants offer flexible multidrop and redundant ring solutions to be created with the dual fibre ports. Large ring networks can be created to provide network resilience to guarantee system functionality, even if a cable is damaged. The ring recovery time ensures that the network devices are not aware of the failure. The fault contact provides a method to communicate network failures.

The ODW-700 series is simple to install, being small, with an easy-to-use integral DIN rail clip. The unit are totally transparent to any data rate, meaning configuration is not needed.

3.2. Available models

| Art. no. | Model | Port | FX fibre |
|-----------|------------|----------------------|-----------------------------|
| 3651-0711 | ODW-710-F1 | PROFIBUS DP (RS-485) | 1 x LC Duplex or LC Simplex |
| 3651-0712 | ODW-710-F2 | PROFIBUS DP (RS-485) | 2 x LC Duplex or LC Simplex |
| 3651-0721 | ODW-720-F1 | RS-232 | 1 x LC Duplex or LC Simplex |
| 3651-0722 | ODW-720-F2 | RS-232 | 2 x LC Duplex or LC Simplex |
| 3651-0731 | ODW-730-F1 | RS-422/485 | 1 x LC Duplex or LC Simplex |
| 3651-0732 | ODW-730-F2 | RS-422/485 | 2 x LC Duplex or LC Simplex |

Table 3. List of available models

3.3. Hardware Overview

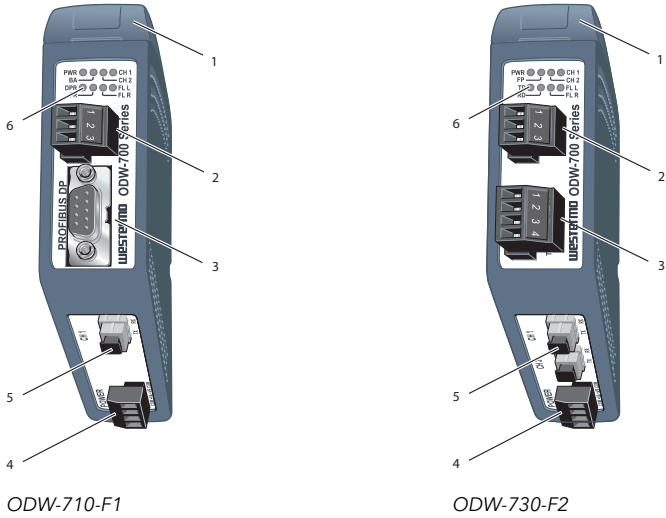

| No. | Description | No. | Description |
|-----|--|-----|-----------------------|
| 1 | Lid for DIP-switches | 2 | Status screw terminal |
| 3 | ODW-710: PROFIBUS DP ODW-720: RS-232 ODW-730: RS-422/485 | 4 | Power screw terminal |
| 5 | FX (fibre, 1 or 2 pcs depending on F1 or F2 model) | 6 | LED indicators |

Figure 3. Location of interface ports and LED indicators

3.4. Connector Information

3.4.1. Power Screw Terminal

| Illustration | Position | Direction | Description | Product marking |
|--------------|----------|-----------|----------------|-----------------|
| | 1 | In | Common voltage | COM |
| | 2 | In | Voltage A | +VA |
| | 3 | In | Voltage B | +VB |
| | 4 | In | Common voltage | COM |

Table 4. Status screw terminal table

The power terminal has two independent inputs, +VA and +VB, allowing redundant power input. The power supply is galvanically isolated from all other interfaces.

3.4.2. Status Screw Terminal

| Illustration | Position | Description | Product marking |
|---|----------|---|-----------------|
|  | 1 | Contact with C when fibre optical links are in operation | NO |
| | 2 | Common | C |
| | 3 | -Open (no contact with C) when fibre optical links are in operation | NC |

Table 5. Status screw terminal table

For ODW-710s: From the factory, the status port is set to trigger on both types of link failures. However, by setting DIP-switch S1:1 (ODW-710s) / S2:6 (ODW-720-F2 and ODW-730-F2) to the ON position, the status port will only trigger when a local link failure has occurred.

For ODW-710s and ODW-720-F2 and ODW-720-F2: Optical link failures can be classified in to two categories, local or remote, as indicated by the FL L and FL R LEDs. A local link failure is when an optical link is down at this particular unit. A remote link failure is when an optical link is down at some other unit.

For ODW-710s: From the factory, the status port is set to trigger on both types of link failures. However, by setting DIP-switch S1:1 (ODW-710s) / S2:6 (ODW-720-F2 and ODW-730-F2) to the ON position, the status port will only trigger when a local link failure has occurred.



NOTE

For ODW-710-F1: Setting DIP-switch S1:1 ON is only applicate if using the ODW-710-F1 together with ODW-710-F2 in a multidrop network.

3.4.3. PROFIBUS DP (ODW-710)

| Illustration | Position | Description | Product marking |
|--------------|----------|-------------|-----------------|
| | 1 | - | - |
| | 2 | - | - |
| | 3 | In/Out | RxD/TxD-P |
| | 4 | Out | CNTR-P |
| | 5 | - | DGND |
| | 6 | Out | VP |
| | 7 | - | - |
| | 8 | In/Out | RxD/TxD-N |
| | 9 | - | - |

Table 6. PROFIBUS DP (RS-485)

The PROFIBUS DP (RS-485) interface is a female 9-position D-sub. Pin assignments are compliance with the PROFIBUS standard EN 50170.

3.4.4. RS-232 (ODW-720)

| Illustration | Position | Direction | Description |
|--------------|----------|-----------|---------------------------|
| | 1 | Out | Data Carrier Detect (DCD) |
| | 2 | Out | Received Data (RD) |
| | 3 | In | Transmitted Data (TD) |
| | 4 | - | Not connected |
| | 5 | - | Signal Ground (SG) |
| | 6 | Out | Data Set Ready (DSR) |
| | 7 | In | Request To Send (RTS) |
| | 8 | Out | Clear To Send (CTS) |
| | 9 | - | Not connected |

Table 7. RS-232 D-sub

The RS-232 interface is a female 9-position D-sub. Pin assignments are compliance with the EIA RS-232 standard.

3.4.5. RS-422/485 Screw Terminal (ODW-730)

| Illustration | Position | Direction | Description | Product marking |
|---|----------|-----------|-------------------|-----------------|
|  | 1 | In | R+ (EIA RS-485 A) | R+ |
| | 2 | In | R- (EIA RS-485 B) | R- |
| | 3 | In/Out | T+ (EIA RS-485 A) | T/R+ |
| | 4 | In/Out | T- (EIA RS-485 B) | T/R- |

Table 8. RS-422/485 screw terminal

This is a 4-position detachable screw terminal that can handle full duplex data rates up to 1.5 Mbit/s and can be set to either 2- or 4-wire RS-485 system. When 4-wire RS-485 is selected, the terminals T/R+ and T/R- will always be set to transmit and terminals R+ and R- will always receive data. Manchester coded protocol can be transferred with synchronous mode.

3.4.6. Optical fibre

The units use Small Form Factor Pluggable (SFP) transceivers. This means that a wide range of different fibre transceivers and connectors can be used.

The ODW-730s use Small Form Factor Pluggable (SFP) transceivers that are in compliance with the Multi-Sourcing Agreement (MSA). This means that a wide range of different fibre transceivers and connectors can be used. For supported transceivers, see SFP data sheet.

3.4.6.1. SFP Transceivers

Each SFP slot can hold one SFP transceiver. See "*Transceiver User Guide 6100-0000*" for transceiver handling instructions, which also can be downloaded from the product support pages at www.westermo.com/support/product-support.

In the event of contamination, the optical connectors in the SFP transceivers should only be cleaned by the use of forced nitrogen and some kind of cleaning stick. Recommended cleaning fluids are methyl-, ethyl-, isopropyl- or isobutyl alcohol, hexane or naphtha.



HANDLING OF SFP TRANSCEIVERS

SFP transceivers are supplied with plugs to avoid contamination inside the optical port. They are very sensitive to dust and dirt. If the fibre optic cable is disconnected from the product, a protective plug must be used on the transmitter/receiver. The protective plug must be kept on during transportation. The fibre optic cable must be handled the same way.

3.5. Functional Description

The functional description gives an overview of the different models. In the illustrations below in this chapter, OVP stands for Over Voltage Protection and OCP stands for Over Current Protection.

3.5.1. Converter PROFIBUS DP - Optical Fibre

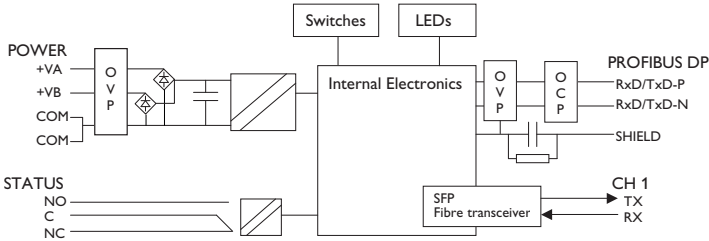

Figure 4. Block diagram for ODW-710-F1

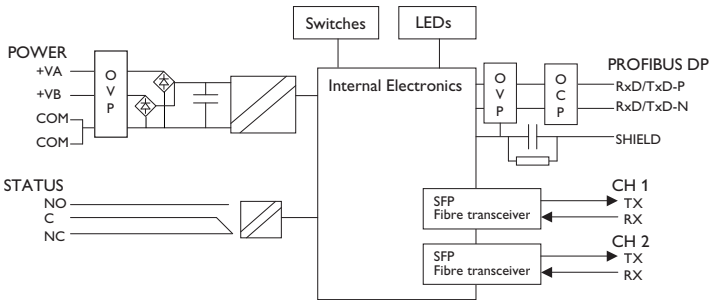

Figure 5. Block diagram for ODW-710-F2

The ODW-710s are fibre optic modems that convert between electrical PROFIBUS DP RS-232 and a fibre optical link. It converts PROFIBUS DP data using data rates from 9 600 bit/s up to 12 Mbit/s. Retiming of the PROFIBUS DP data ensures that the correct signal form is transmitted from the ODW-710 converters.

The PROFIBUS data rate is set automatically as soon as the ODW-710 receives a correct data frame, whether data is received from PROFIBUS DP or the fibre optic link. The detected data rate remains until a number of consecutive faulty received frames have been detected or no further frames are detected within the timeout period. The timeout period is set by switches, with the default setting of 31 faulty frames or 5 seconds without any received frames.

The ODW-710-F2 is a fibre optic repeater that repeats received data from one fibre link out to the other link. This is useful e.g. for long distance communication, where electromagnetic interference may occur or when isolation of the electrical network is

needed. The maximum optical fibre distance depends on selected fibre transceiver and fibre type. Distances up to 80 km (50 miles) are available.

3.5.2. Converter Serial Interface - Optical Fibre

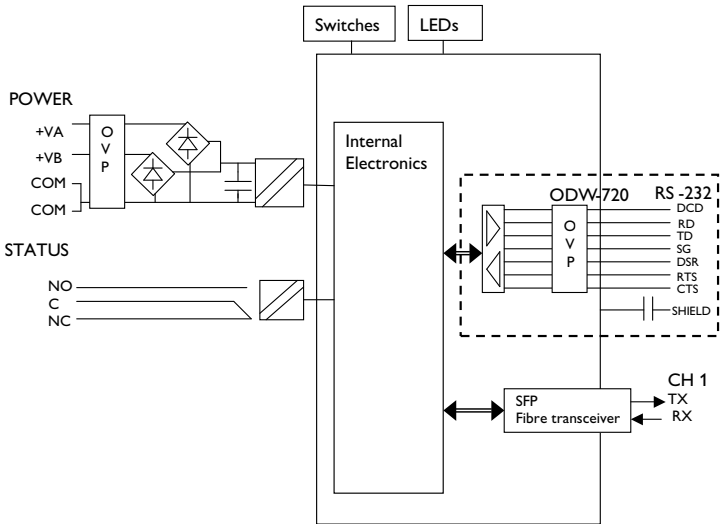

Figure 6. Block diagram for ODW-720-F1

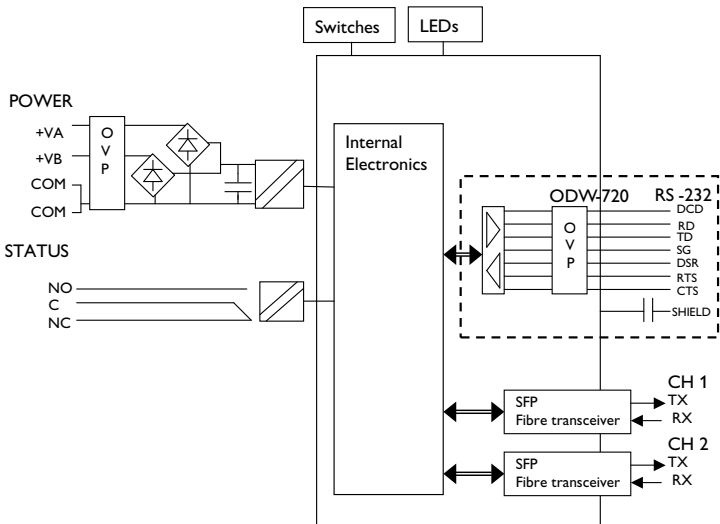

Figure 7. Block diagram for ODW-720-F2

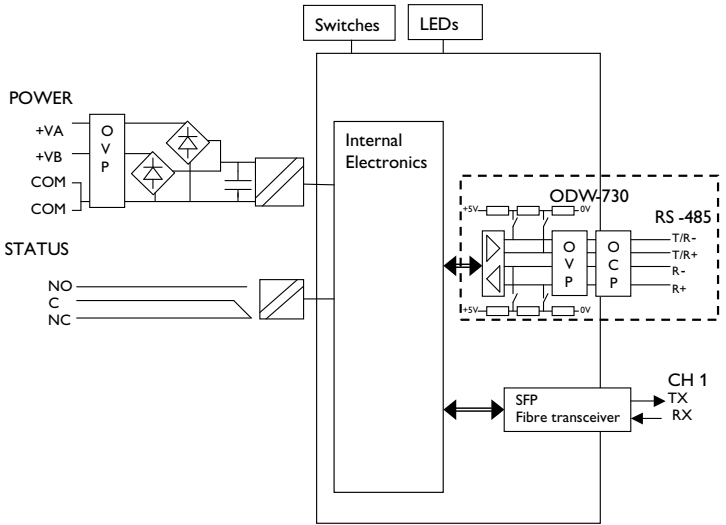

Figure 8. Block diagram for ODW-730-F1

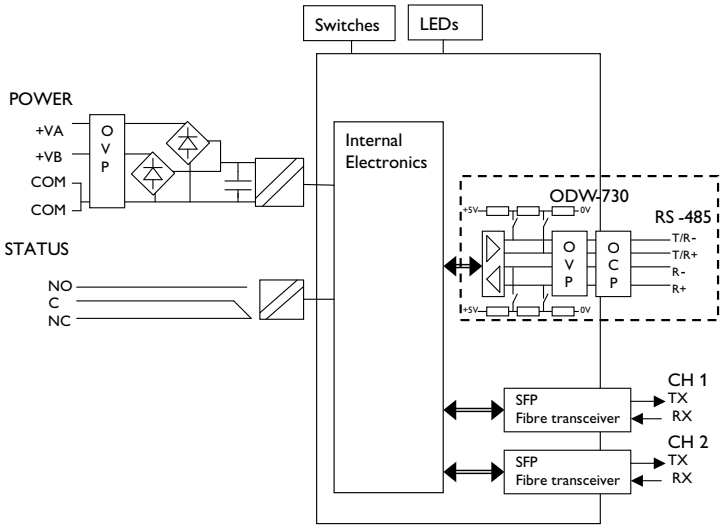

Figure 9. Block diagram for ODW-730-F2

The ODW-720s and ODW-730s are fibre optic modems. The ODW-720s convert between electrical RS-232 and a fibre optical link, while the ODW-730s convert between electrical RS-485 and a fibre optical link.

The ODW-720s can convert from RS-232 to RS-485 by using a ODW-720 in the same link as a ODW-730, while the ODW-730 can convert from RS-485 to RS-232 by using a ODW-730 in the same link as a ODW-720.

The ODW-720-F1 converts data using rates from 300 bit/s up to 250 kbit/s.

3.5.3. Repeater - Optical Fibre Links

The ODW-720s and ODW-730s are fibre optic repeaters that repeat received data from one fibre link out to the other link. This is useful e.g. for long distance communication, where electromagnetic interference may occur or when isolation of the electrical network is needed.

The maximum optical fibre distance depends on selected fibre transceiver and fibre type. Distances up to 80 km (50 miles) are available.

3.6. LED Indicators

| LED | Status | Description |
|---|----------|--|
| PWR | ON | Power is on. |
| | OFF | Power is off. |
| BA ^a Bus active | ON | Data rate has been identified and data frames are being received on the electrical or optical interface. |
| | OFF | Data rate has not been identified. |
| FP ^b | ON | Focal point. |
| | OFF | Redundant ring member or multidrop unit. |
| CH 2 ^c Channel 2 link status | ON | Fiber link to other unit has been established at CH 2. |
| | Flashing | Optical power detected but link to other unit has not been established at CH 2. |
| | OFF | No optical power detected and no link to other unit has been established at CH 2. |
| CH 1 Channel 1 link status | ON | Fiber link to other unit has been established at CH 1. |
| | Flashing | Optical power detected but link to other unit has not been established at CH 1. |
| | OFF | No optical power detected and no link to other unit has been established at CH 1. |
| DPR ^a Receive PROFIBUS DP | Flash | Data received on the electrical interface and transmitted out on the optical interface. |
| | OFF | No data received on the electrical interface. |
| FR ^a Receive fibre link | Flash | Data received on the optical interface and transmitted out on the electrical interface. |
| | OFF | No data received on the optical interface. |
| TD ^d | Flash | Data received on the electrical interface and transmitted out on the optical interface. |
| | OFF | No data received on the electrical interface. |
| RD ^d | Flash | Data received on the optical interface and transmitted out on the electrical interface. |
| | OFF | No data received on the optical interface. |
| FL R Failure link remote | ON | Remote fibre link failure. A fibre link is out of operation at any other unit than this one. |
| | Flashing | Hardware error or invalid configuration. |
| FL L Failure link local | ON | Local fibre link failure. A fibre link is out of operation at this unit. |
| | Flashing | Hardware error or invalid configuration. |

^aApplicable only for ODW-710 models

^bApplicable only for ODW-720-F2 and 730-F2, not used on ODW-720-F1 and ODW-730-F1

^cApplicable only for F2 models, not used on F1 models

^dApplicable only for ODW-720 and ODW-730 models

Table 9. LED indicators

3.7. Dimensions

Dimensions are stated in mm and are regardless of model.

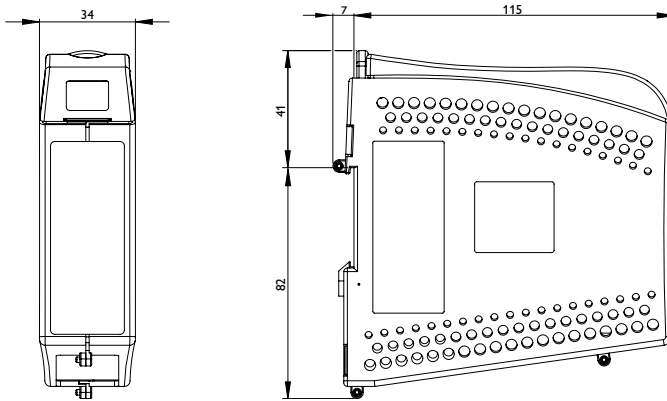

Figure 10. Dimensional drawing

4. Installation

4.1. Mounting

This product should be mounted on a 35 mm DIN-rail, which is horizontally mounted inside an apparatus cabinet or similar. It is recommended that the DIN-rail is connected to ground. Snap on the product to the DIN-rail according to the figure.

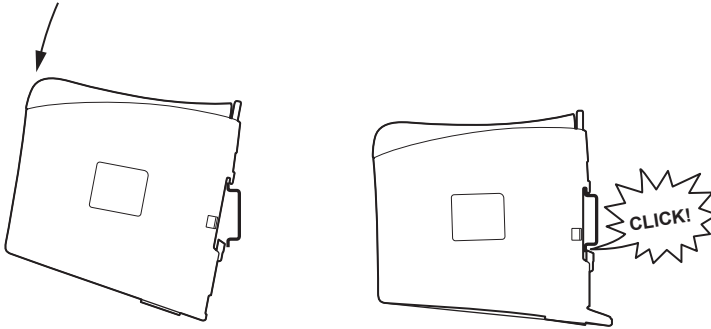

Figure 11. Mounting of product

4.2. Removal of Product

Press down the black support at the top of the unit.

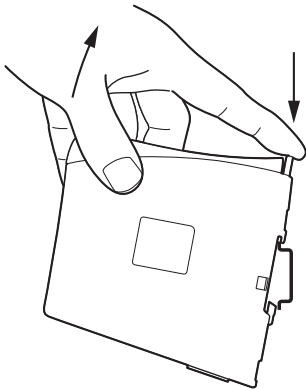

Figure 12. Removal of product

4.3. Cooling

This product uses convection cooling. Spacing is recommended for the use of the product in full operating temperature range and service life. To avoid obstructing the airflow around the product, use the following spacing rules.

A minimum spacing of 25 mm (1 inch) above and below, and 10 mm (0.4 inches) left and right of the product is recommended.

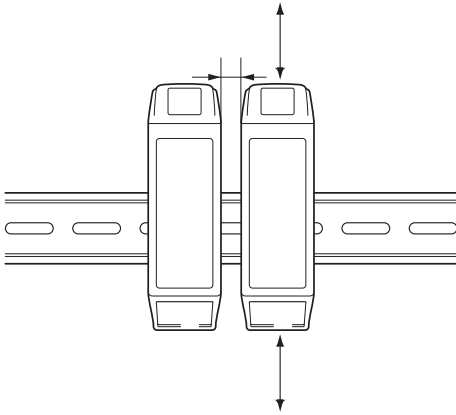

Figure 13. Minimum spacing of product

4.4. Settings and Configuration



HAZARDOUS VOLTAGE

Do not open an energised product. Hazardous voltage may occur when connected to a power supply.



ELECTROSTATIC DISCHARGE (ESD)

Prevent electrostatic discharge damage to internal electronic parts by discharging your body to a grounding point (e.g. use a wrist strap).

4.4.1. ODW-710 models

4.4.1.1. DIP-Switch Settings, ODW-710 Models

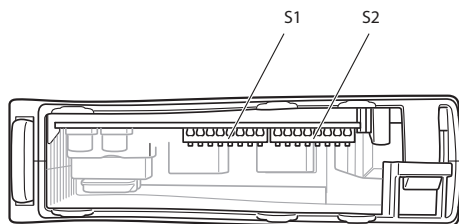





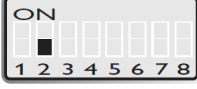





















Figure 14. ODW-710 DIP-switches







| S1 DIP-switch | S2 DIP-switch | Description |
|---|---|--|
|  |  | 1 faulty frame before data rate seen as unidentified. S1: No extended retry limit. ^a |
|  |  | 2 faulty frames before data rate seen as unidentified. S1: No extended retry limit. ^a |
|  |  | 3 faulty frames before data rate seen as unidentified. S1: No extended retry limit. ^a |
|  |  | 4 faulty frames before data rate seen as unidentified. S1: No extended retry limit. ^a |
|  |  | 5 faulty frames before data rate seen as unidentified. S1: No extended retry limit. ^a |
|  |  | 6 faulty frames before data rate seen as unidentified. S1: No extended retry limit. ^a |
|  |  | 7 faulty frames before data rate seen as unidentified. S1: No extended retry limit. ^a |
|  |  | 8 faulty frames before data rate seen as unidentified. S1: No extended retry limit. ^a |
|  |  | 31 faulty frames before data rate seen as unidentified. S1: Extended retry limit. ^a |
|  |  | 63 faulty frames before data rate seen as unidentified. S1: Extended retry limit. ^a |
|  |  | 127 faulty frames before data rate seen as unidentified. S1: Extended retry limit. ^a |

| | | |
|---|---|---|
|  |  | 255 faulty frames before data rate seen as unidentified. S1: Extended retry limit. ^a |
|  | | Set status port at local fibre link (FL L) error only. ^b |
|  |  | Factory default |

^aSee section "About the automatic data rate detection" for a more detailed description.

^bFor ODW-710-F1: only applicable if used together with ODW-710-F2 units in a multidrop network.

Table 10. S1 and S2 DIP-switch for ODW-710

| S2 DIP-switch | Description | S2 DIP-switch | Description |
|---|--|---|---|
|  | Multidrop mid unit or redundant ring member. ^a |  | 5 seconds interruption in receiving frames, until inactive BA ^b . |
|  | Multidrop end unit. E.g. the first or last unit in a multidrop network. Always "ON" for ODW-710-F1. |  | 10 seconds interruption in receiving frames, until inactive BA ^b . |
|  | Redundant ring focal point (ODW-710-F1) master unit (ODW-710-F2). Only one focal point/master unit allowed in a ring. ^a |  | 20 seconds interruption in receiving frames, until inactive BA ^b . |
|  | 65535 t _{bit} interruption in receiving frames, until inactive BA | | |

^aOnly available for ODW-710-F2

^bSee section "About the automatic data rate detection" for a more detailed description.

Table 11. S2 DIP-switch for ODW-710

4.4.1.2. Configuration ODW-710-F1

ODW-710-F1 LED Indication under Normal Operation

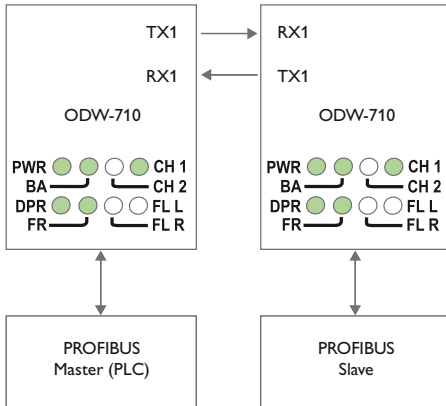

Figure 15. LED indication under normal operation

Data from the PROFIBUS master is received at the ODW-710-F1 electrical port (as indicated by the DPR LED), data rate is automatically detected (as indicated by the BA LED), data bits are retimed according to the determined rate and sent out on the optical fibre at CH 1.

The ODW-710-F1 slave unit receives data at optical fibre CH 1 (as indicated by the FR LED), data rate is automatically detected (as indicated by the BA LED) and data is sent out on the electrical port.

Responses from the PROFIBUS slaves are processed in the same fashion and sent back to the PROFIBUS master in the opposite direction.

ODW-710-F1 LED Indication during Optical Link Failure

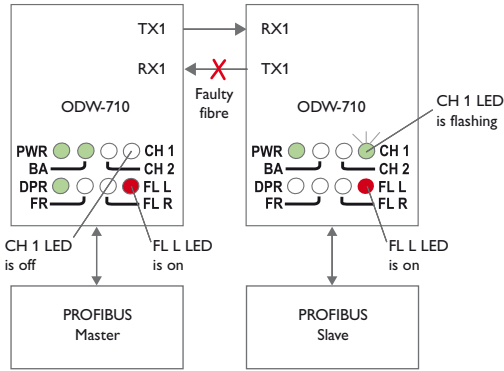

Figure 16. LED indication during optical link failure 1

If one fibre in the optical fibre pair fails, all communication will be lost and the FL L LEDs will turn on. The ODW-710-F1 that is still sensing optical power will indicate this by flashing the CH1 LED.

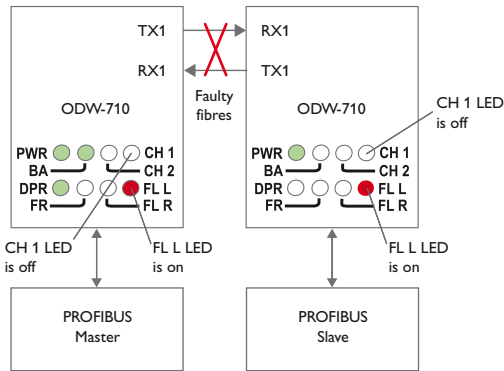

Figure 17. LED indication during optical link failure 2

If both fibres in the optical fibre pair fails, all communication will be lost, the CH1 LEDs will turn off and the FL R LED will turn on.

ODW-710 Calculating System Processing Delay

Data exchange between a PROFIBUS DP master and slave via ODW-710-F1 or ODW-710-F2 fibre optic link will be delayed due to the length of the optical fibre and the signal processing within the ODW-710-F1/ODW-710-F2. The signal processing delay is dependent on the data rate, and the fibre delay is dependent on the total length of the optical fibre. The additional time resulting from the optical fibre and ODW-710-F1/ODW-710-F2 is the overall system delay.

| | Delay at < 1.5 Mbit/s | Delay at 3 to 12 Mbit/s |
|---|---|---|
| 1. Optical fibre length delay (typical) | 5 µs/km | 5 µs/km |
| 2. Signal processing, electrical to fibre (max) | $1 t_{\text{bit}}^{\text{a}} + 1 \mu\text{s}$ | $9 t_{\text{bit}}^{\text{a}} + 1 \mu\text{s}$ |
| 3. Signal processing, fibre to electrical (max) | 0.3 µs | 0.3 µs |
| 4. Signal processing, fibre to fibre (max) | 1.3 µs | 1.3 µs |

^a $t_{\text{bit}} = 1/\text{Baud rate}$ (Baud rate in bit/s)

Table 12. Calculating system processing delay

Example:

One PROFIBUS DP master and 11 slaves with data rate 12 Mbit/s. 12 ODW-710-F2 units with a total fibre length of 40 km. A data frame sent from the master to a slave at the farthest end of the optical network.

- The total optical fibre length delay.
 $40 \times 5 \mu\text{s} = 200 \mu\text{s}$
- Signal processing delay, electrical to fiber (ODW-710-F1/ODW-710-F2 units connected to PROFIBUS DP master).
 $9 t_{\text{bit}} + 1 \mu\text{s} = 9 \times 0.083 \mu\text{s} + 1 \mu\text{s} \times 2 = 1.1 \mu\text{s}$
- Signal processing, fibre to electrical: Signal processing delay (ODW-710-F1/ODW-710-F2 units connected to PROFIBUS DP slave).
0.3 µs
- For ODW-710-F2 only: Signal processing, fibre to fibre: The optical repeater delay x Number of optical repeaters (excluding the ODW-710-F2 units connected to PROFIBUS DP master and addressed slave).
 $(12 - 2) \times 1.3 \mu\text{s} = 13 \mu\text{s}$
- The system delay is calculated by summing the delays in item 1 to 4 above:
ODW-710-F1: $200 \mu\text{s} + 1.1 \mu\text{s} + 0.3 \mu\text{s} = 201.4 \mu\text{s}$
ODW-710-F2: $200 \mu\text{s} + 1.1 \mu\text{s} + 0.3 \mu\text{s} + 13 \mu\text{s} = 214 \mu\text{s}$

4.4.1.3. Configuration ODW-710-F2

Multidrop Configuration

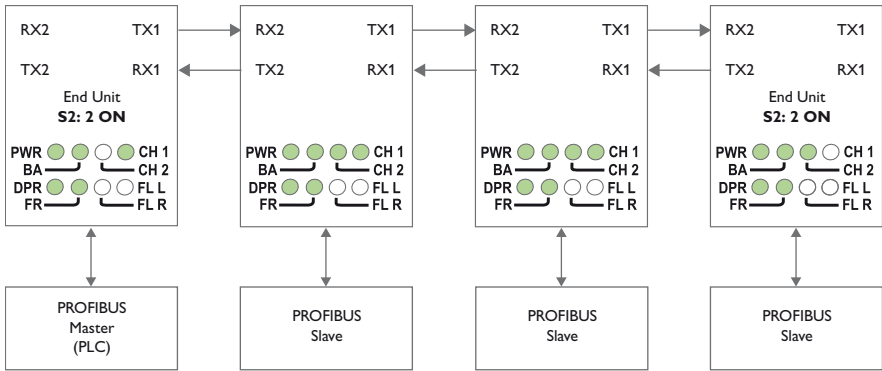

Figure 18. Multidrop configuration ODW-710-F2

Prepare the PROFIBUS Units

1. Configure PROFIBUS network, with master and slaves. Check that the application runs correctly with the electrical PROFIBUS network.



NOTICE

In an ODW-710-F2 fibre optic network there will be some additional processing delays that do not exist in an electrical bus. It is possible that the PROFIBUS application must be adjusted to accommodate these delays if using many ODW-710-F2 units in a large network.

See “Calculating system processing delay” for more information on how to determine the overall system delay time.

Prepare the Fibre Optical Network

1. One, and only one, of the ODW-710-F2 units must be configured as a Ring Focal Point by setting DIP-switch S2:3 to the ON position. (The Ring Focal Point acts as a logical end point in the optical fibre ring, thus forming a bus type of structure).
2. Connect the fibre pairs between the units. Always connect CH 1 from one unit to CH 2 on the next unit as shown in the picture above.
3. Connect the power supply to all units and verify that all fibre links become active. (CH 1 and CH 2 LEDs are on, FL L and FL R LEDs are off.)
4. Connect the PROFIBUS master and slaves to the corresponding ODW-710-F2 unit.

5. The network is now up and running.

Data from the PROFIBUS master is received at the ODW-710-F2 electrical port (as indicated by the DPR LED). The data rate is automatically detected (as indicated by the BA LED) and data bits are retimed according to the determined rate and sent out on the optical fibre at CH 1.

The first ODW-710-F2 slave unit receives data at optical fibre CH 2 (as indicated by the FR LED). The data rate is automatically detected (as indicated by the BA LED) and data is sent out on the electrical port. The slave unit also repeats incoming data on CH 2 to the next slave unit.

Responses from the PROFIBUS slaves are processed in the same fashion and sent back to the PROFIBUS master in the opposite direction.

Behavior during Optical Link Failure

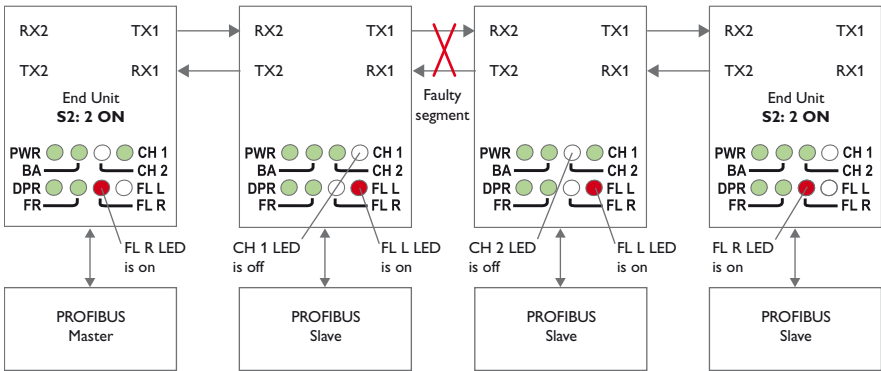

Figure 19. Behavior during optical link failure

If an optical fibre segment fails, all communication with units beyond the faulty fibre segment will be lost. To determine which fibre segment has failed, look at the FL L, CH 1 and CH 2 LEDs as show in the picture above.

Redundant Ring Configuration

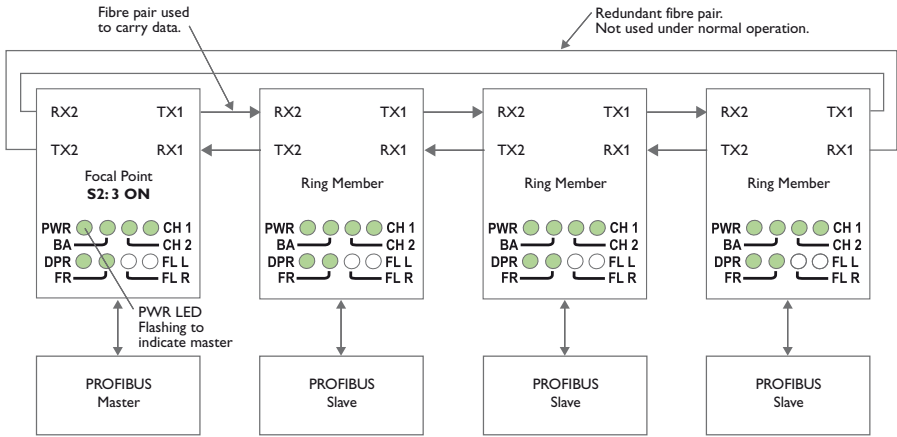

Figure 20. Redundant ring configuration

Prepare the PROFIBUS Units

1. Configure PROFIBUS network, with master and slaves. Check that the application runs correctly with the electrical PROFIBUS network.



NOTICE

In an ODW-710-F2 fibre optic network there will be some additional processing delays that do not exist in an electrical bus. It is possible that the PROFIBUS application must be adjusted to accommodate these delays if using many ODW-710-F2 units in a large network.

See “Calculating system processing delay” for more information on how to determine the overall system delay time.

Prepare the Fibre Optical Network

1. One, and only one, of the ODW-710-F2 units must be configured as a Ring Focal Point by setting DIP-switch S2:3 to the ON position. (The Ring Focal Point acts as a logical end point in the optical fibre ring, thus forming a bus type of structure).
2. Connect the fibre pairs between the units. Always connect CH 1 from one unit to CH 2 on the next unit as shown in the picture above.
3. Connect the power supply to all units and verify that all fibre links become active. (CH 1 and CH 2 LEDs are on, FL L and FL R LEDs are off.)
4. Connect the PROFIBUS master and slaves to the corresponding ODW-710-F2 unit.

5. The network is now up and running.

Data from the PROFIBUS master is received at the ODW-710-F2 electrical port (as indicated by the DPR LED). The data rate is automatically detected (as indicated by the BA LED) and data bits are retimed according to the determined rate and sent out on the optical fibre at CH 1.

The first ODW-710-F2 slave unit receives data at optical fibre CH 2 (as indicated by the FR LED). The data rate is automatically detected (as indicated by the BA LED) and data is sent out on the electrical port. The slave unit also repeats incoming data on CH 2 to the next slave unit.

Responses from the PROFIBUS slaves are processed in the same fashion and sent back to the PROFIBUS master in the opposite direction.

Behavior during Optical Link Failure

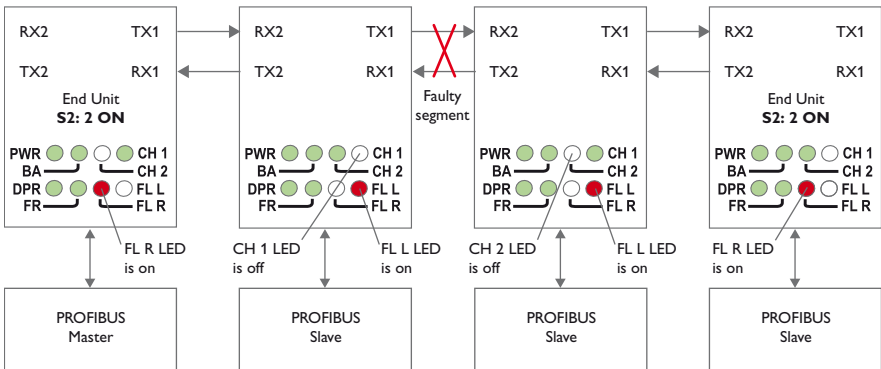

Figure 21. Behavior during optical link failure

If an optical fibre segment fails, the ODW-710-F2 focal point will switch mode and start sending out data on both optical fibre ports, CH 1 and CH 2, simultaneously. Responses from the PROFIBUS slaves are sent back to the PROFIBUS master in the opposite direction, as normal. To determine which fibre segment has failed, look at the FL L, CH 1 and CH 2 LEDs as show in the picture above.



NOTE

If a fibre link fails, there will be some time before the system reconfigures itself during which data may be corrupted or lost. See "Reconfiguration time under faulty condition" for more information on how to determine the system reconfiguration time.

4.4.1.4. Start-up Guide ODW-710-F1

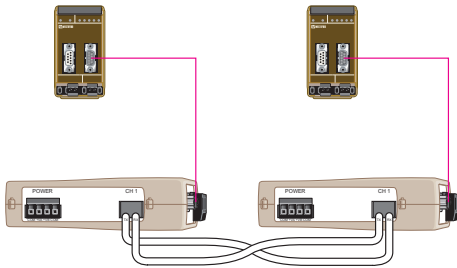

Figure 22. Point-to-point application

Using the factory DIP-switch settings:

1. Connect the fibre link between the ODW-710-F1s.
2. Connect the power supply to both ODW-710-F1s.
3. After a few seconds, the fibre link should be in operation, indicated by an active CH1 LED.
4. Connect the PROFIBUS DP connectors between both ODW-710-F1 and PROFIBUS units configured to be units in the PROFIBUS DP network.
5. The PROFIBUS DP will be in operation and the data rate will be automatically detected, as indicated by the BA LED.
6. The point-to-point application is up and running



NOTICE

In an ODW-710-F1 fibre optic link there will be some additional processing delays that do not exist in an electrical bus. It is possible that the PROFIBUS application must be adjusted to accommodate for this delay. See "Calculating system processing delay" for more information on how to determine the overall system delay time.

4.4.1.5. Prepare the Fibre Optical Network

The ODW-710s automatically detects the data rate by monitoring incoming PROFIBUS data frames on both the electrical and optical interfaces. When the data rate has been established, the BA LED will go active.

If no data frames are transmitted for a period of time, the automatic data rate detection will restart and the BA LED will go inactive.

The idle time before the automatic data rate detection restarts is set using DIP-switches S2:4 and S2:5. The factory default setting is 5 seconds.

The automatic data rate detection determines the actual data rate by listening for PROFIBUS Start Delimiters (SD1 - SD4) at the beginning of each data frame. If one or more Start Delimiters are lost the automatic data rate detection will rest start.

The number of lost Start Delimiters before the automatic data rate detection restarts is set using DIP-switches S1:2 and S2:6 - S2: 8. The factory default setting is 31 faulty frames (31 lost Start Delimiters).



NOTE

Start Delimiters can be lost during an electrical or optical disturbance.

For example a PROFIBUS slave unit is connected/disconnected or an optical fibre is disconnected. It is advisable to start of by using the factory default settings and only manipulate them if a problem exists.

4.4.2. ODW-720 models

4.4.2.1. DIP-Switch Settings, ODW-720 Models

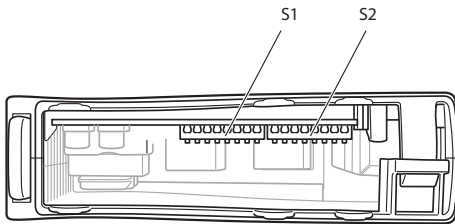

Figure 23. ODW-720 DIP-switches

The ODW-720-F1 DIP-switches are pre-set from the factory, so that the unit can be used for point-to-point applications, together with an additional ODW-720-F1, straight out of the box, without the need for any type of user configuration. The only choice required, is if to enable the RTS to CTS signalling function or not. See the DIP-switch S2:1 description below.

| S1 DIP-switch | Description |
|---------------|--|
| | S1:1 - S1:8 always OFF for point-to-point applications |

Table 13. S1 DIP-switch for ODW-720-F1

S1 DIP-switch, asynchronous mode speed selection

















| | | | | | |
|---|------------|---|-------------|---|---------------------|
|  | 300 bit/s |  | 38.4 bit/s |  | 250 bit/s |
|  | 1200 bit/s |  | 57.6 bit/s |  | 9 bits data format |
|  | 2400 bit/s |  | 115.2 bit/s |  | 10 bits data format |
|  | 4800 bit/s |  | 125 bit/s |  | 11 bits data format |
|  | 9600 bit/s |  | 187.5 bit/s |  | 12 bits data format |
|  | 19.2 bit/s |  | 230.4 bit/s | | |

Table 14. DIP-switch for ODW-720-F2

Supervision table when selecting data format

| | | | | | | | | |
|---------------|---|----|----|----|----|----|----|----|
| Start bit | x | x | x | x | x | x | x | x |
| 7 bit | x | x | x | | x | | | |
| 8 bit | | | | x | | x | x | x |
| Parity | | | x | | x | | x | x |
| 1 stop bit | x | | x | x | | | x | |
| 2 stop bit | | x | | | x | x | | x |
| Number of bit | 9 | 10 | 10 | 10 | 11 | 11 | 11 | 12 |

Table 15. Supervision table for ODW-720-F2

S1 DIP-switch, synchronous mode time frame selection

| | | | | | |
|--|----------------|--|----------------|--|-------------|
| | 1.6 m/s | | 26 μ s | | 2.6 μ s |
| | 416 μ s | | 13 μ s | | 2.1 μ s |
| | 208 μ s | | 8.6 μ s | | 2 μ s |
| | 104 μ s | | 4.3 μ s | | |
| | 52 μ s | | 4 μ s | | |

Table 16. S1 DIP-switch for ODW-720-F2

S1 DIP-switch, description V/Y mode

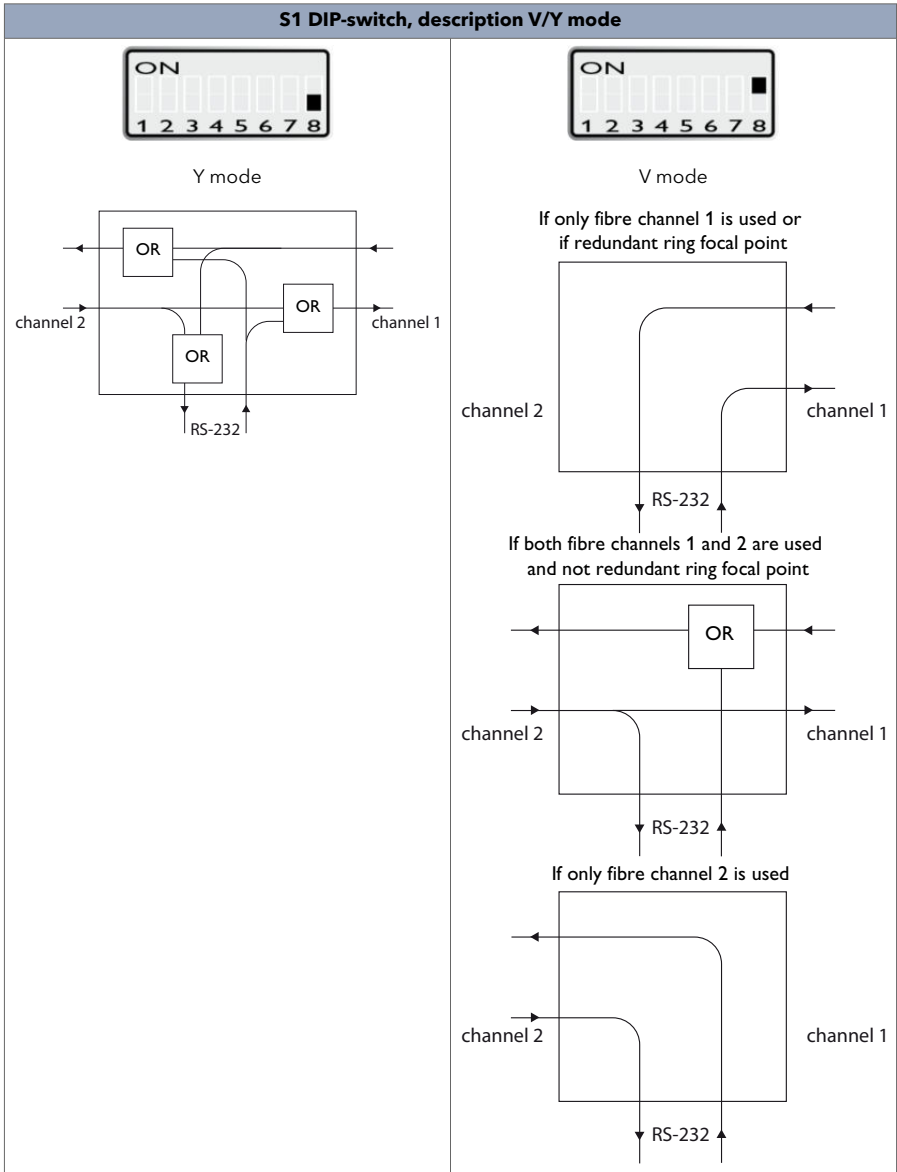

Table 17. S1 DIP-switch for ODW-720-F2

For applications that only require half duplex communication it is recommended to use Y-mode. Please see the [ODW-720 Management Guide \[46\]](#) for further details.













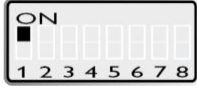

| S2 DIP-switch | Description | S2 DIP-switch | Description |
|---|----------------------|---|--|
|  | CTS always active |  | S2:2 and S2:4 - S2:7 always OFF, S2:3 and S2:8 always ON for point-to-point applications |
|  | Transport RTS to CTS | | |

Table 18. S2 DIP-switch for ODW-720-F1

| S2 DIP-switch | Description | S2 DIP-switch | Description |
|---|--|---|---|
|  | CTS always active |  | Use secondary data channel ^a . |
|  | Transport RTS to CTS ^a . |  | Single channel system redundant ring, e.g. only the primary or secondary channel is used |
|  | Multidrop mode |  | Dual channel system redundant ring, e.g. both the primary and secondary channel are used simultaneously |
|  | Redundant ring mode |  | Set status port on both local fibre link (FL L) and remote fibre link (FL R) errors |
|  | Multidrop mid unit or redundant ring member |  | Set status port on local fibre link (FL L) error only |
|  | Multidrop end unit, redundant ring focal point |  | S2:7 has no function |
|  | Use primary data channel |  | Always OFF |

^aRTS to CTS transport and secondary channel cannot be used at the same time.

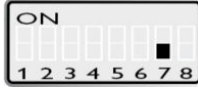
Table 19. S2 DIP-switch for ODW-720-F2

Factory default for ODW-720-F1 and ODW-720-F2



S1, both models

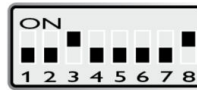

S2, ODW-720-F1



S2, ODW-720-F2

Table 20. Factory default for ODW-720-F1 and ODW-720-F2

4.4.2.2. Start-up Guide ODW-720-F1, Point-to-Point Application

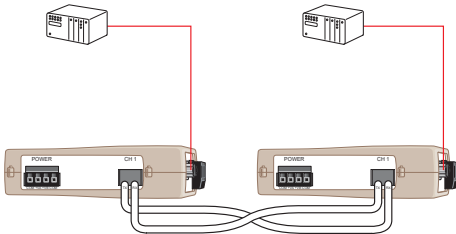

Figure 24. Point-to-point application, left is master, right is slave

Using the factory DIP-switch settings:

1. Set DIP-switch S2:1 as desired.
2. Connect the fibre link between the ODW-720-F1s.
3. Connect the power supply to both ODW-720-F1s.
4. After a few seconds, the fibre link should be in operation, indicated by an active CH1 LED.
5. Connect the serial cables from PLC master and slave to respective ODW-720-F1.
6. Frames from PLC master that are correctly received at the ODW-720-F1 should be indicated by flashing TD LED.
7. Frames that are received via the fibre link will be transmitted to the PLC slave and indicated by flashing RD LED.
8. Replies from slave to master will be transferred and indicated in the opposite way.
9. The point-to-point application is up and running

4.4.2.3. Referring Documents, ODW-720-F2

For detailed information on how to configure the ODW-720-F2 for different applications, please see the document below.

| Type | Description | Document no. |
|------------------|-------------|--------------|
| Management guide | ODW-720-F2 | 6651-2235 |

Table 21. Referring documents

4.4.3. ODW-730 models

4.4.3.1. DIP-Switch Settings, ODW-730 Models

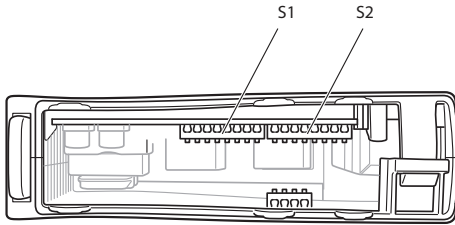

Figure 25. ODW-730-F1 DIP-switch

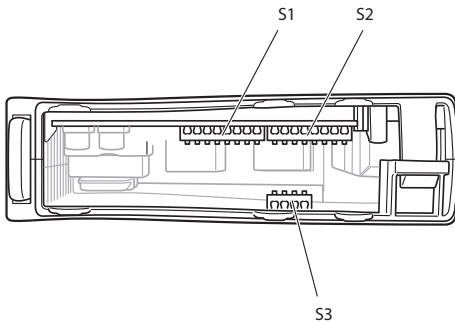

Figure 26. ODW-730-F2 DIP-switch

S1 DIP-switch, asynchronous mode speed selection





















| | | | | | |
|---|---------------|---|----------------|---|---|
|  | 300 bit/s |  | 57.6 bit/s |  | 1.0 Mbit/s |
|  | 1200 bit/s |  | 115.2 bit/s |  | 1.5 Mbit/s |
|  | 2400 bit/s |  | 125 bit/s |  | 9 bits data format |
|  | 4800 bit/s |  | 187.5 bit/s |  | 10 bits data format |
|  | 9600 bit/s |  | 230.4 bit/s |  | 11 bits data format |
|  | 19.2 bit/s |  | 250 bit/s |  | 12 bits data format |
|  | 38.4 bit/s |  | 500 kbit/s |  | S:1:8 always OFF for point-to-point applications. Only applicable for ODW-730-F1. |















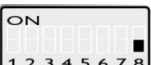

Table 22. S1 DIP-switch for ODW-730-F1 and ODW-730-F2

Supervision table when selecting data format

| | | | | | | | | |
|---------------|---|----|----|----|----|----|----|----|
| Start bit | x | x | x | x | x | x | x | x |
| 7 bit | x | x | x | | x | | | |
| 8 bit | | | | x | | x | x | x |
| Parity | | | x | | x | | x | x |
| 1 stop bit | x | | x | x | | | x | |
| 2 stop bit | | x | | | x | x | | x |
| Number of bit | 9 | 10 | 10 | 10 | 11 | 11 | 11 | 12 |

Table 23. Supervision table for ODW-730-F1 and ODW-730-F2

S1 DIP-switch, synchronous mode time frame selection

| | | | | | |
|---|---------|---|--------|---|---|
|  | 1.6 m/s |  | 13 μs |  | 2 μs |
|  | 416 μs |  | 8.6 μs |  | 1 μs |
|  | 208 μs |  | 4.3 μs |  | 500 ns |
|  | 104 μs |  | 4 μs |  | 300 ns |
|  | 52 μs |  | 2.6 μs |  | S:1:8 always OFF for point-to-point applications ^a . |
|  | 26 μs |  | 2.1 μs | | |

^aOnly applicable for ODW-730-F1

Table 24. S1 DIP-switch for ODW-730-F1 and ODW-730-F2

S1 DIP-switch, description V/Y mode



Y mode

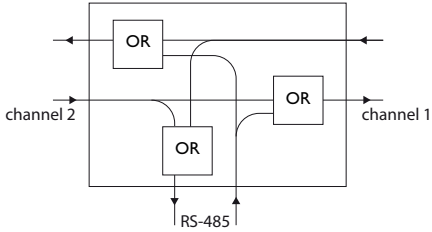

V mode

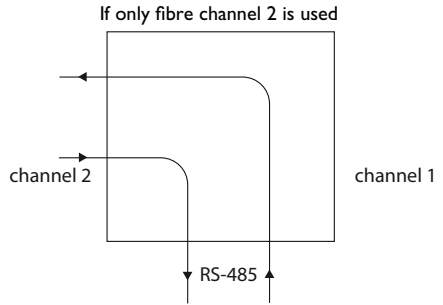
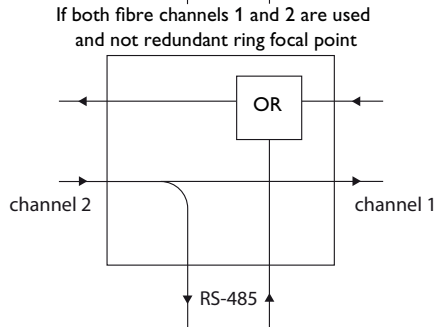
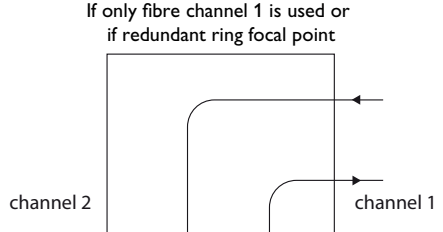

Table 25. S1 DIP-switch for ODW-730-F2

For applications that only require half duplex communication it is recommended to use Y-mode.



| S2 DIP-switch | Description | S2 DIP-switch | Description |
|---|---------------|---|---|
|  | RS-485 2-wire |  | S2:2 and S2:4-S2:8 always OFF, S2:3 always ON for point-to-point applications |
|  | RS-422 4-wire | | |

Table 26. S2 DIP-switch for ODW-730-F1













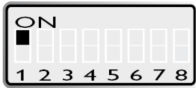

| S2 DIP-switch | Description | S2 DIP-switch | Description |
|---|--|---|---|
|  | RS-485 2-wire |  | Use secondary data channel |
|  | RS-422 4-wire |  | Single channel system redundant ring, e.g. only the primary or secondary channel is used |
|  | Multidrop mode |  | Dual channel system redundant ring, e.g. both the primary and secondary channel are used simultaneously |
|  | Redundant ring mode |  | Set status port on both local fibre link (FL L) and remote fibre link (FL R) errors |
|  | Multidrop mid unit or redundant ring member |  | Set status port on local fibre link (FL L) error only |
|  | Multidrop end unit, redundant ring focal point |  | S2:7 has no function |
|  | Use primary data channel |  | Always OFF |

Table 27. S2 DIP-switch for ODW-730-F2



| S3 DIP-switch | Description | S3 DIP-switch | Description |
|---|-------------------------------------|---|-------------------------------------|
|  | No termination and fail-safe |  | Termination with fail-safe (2-wire) |
|  | Termination with fail-safe (4-wire) | | |

Table 28. S3 DIP-switch for ODW-730-F1 and ODW-730-F2



| Factory default | Description | Factory default | Description |
|---|-----------------|---|----------------|
|  | S1, both models |  | S2, ODW-730-F1 |
| | |  | S2, ODW-730-F2 |

Table 29. Factory default for ODW-730-F1 and ODW-730-F2

4.4.3.2. Start-up Guide ODW-730-F1, Point-to-Point Application

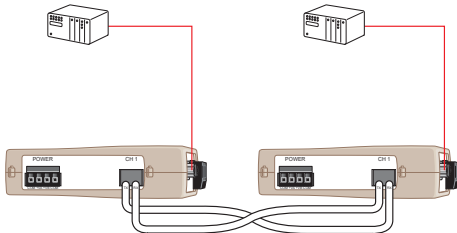

Figure 27. Point-to-point application, left is master, right is slave

Follow the steps below to get the unit up and running in a simple application.

1. Make sure that DIP-switches S1:8 and S2:2 - S2:8 are set to factory default positions. (I.e. S1:8 OFF, S2:2 OFF, S2:3 ON and S2:4 - S2:8 OFF).
2. Configure both ODW-730-F1 units for the correct speed and data format using DIP-switches S1:1 - S1:7.
3. Select RS-485 2- or 4-wire mode using DIP-switch S2:1 (OFF = 2-wire, ON = 4-wire).
4. Enable the RS-485 termination / fail safe if required using DIP-switches S3:1 - S3:4 (S3:1 and S3:2 = 4-wire termination, S3:3 and S3:4 = 2-wire connection.)
5. Connect the fibre link between the ODW-730-F1.

6. Connect the power supply to both ODW-730-F1.
7. After a few seconds the fibre link should be in operation, indicated by an active CH1 LED.
8. Connect the serial cables from PLC master and slave to respective ODW-730-F1.
9. Frames from PLC master that are correctly received at the ODW-730-F1 should be indicated by flashing TD LED.
10. Frames that are received via the fibre link will be transmitted to the PLC slave and indicated by flashing RD LED.
11. Replies from slave to master will be transferred and indicated in the opposite way.
12. The point-to-point application is up and running

4.4.3.3. ODW-730, RS-485 termination at system level

The system should be installed in according to the RS-485 specification. A system should always form a bus structure where the termination is at the end points of the bus. See diagrams for details of how this is done with RS-485 2-wire and 4-wire.

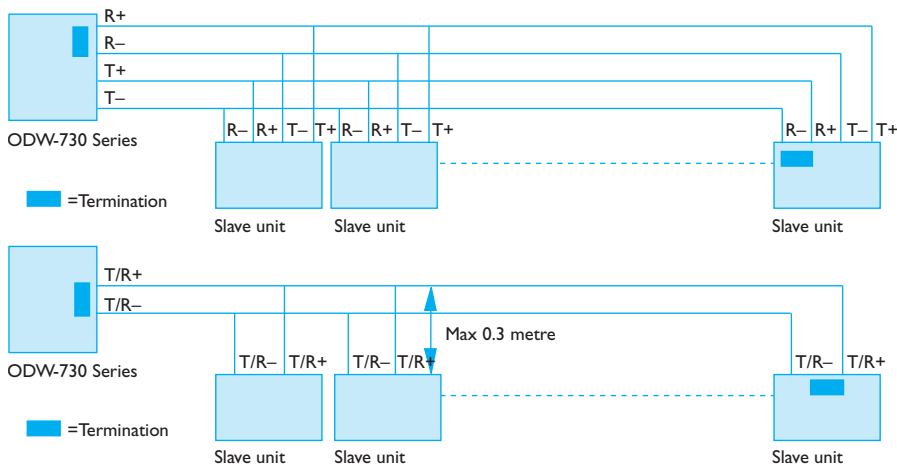

Figure 28. Termination at system level



NOTE

R+/R-, T+/T- definitions are not standard, it can help to shift + and - if the unit does not work.

4.4.3.4. Referring Documents, ODW-730-F2

For detailed information on how to configure the ODW-730-F2 for different applications, please see the document below.

| Type | Description | Document no. |
|------------------|--------------------|---------------------|
| Management guide | ODW-730-F2 | 6651-2255 |

Table 30. Referring documents

5. Specifications

5.1. Interface Specifications

| Power | |
|--------------------------------------|---|
| Rated voltage | 12 to 48 VDC and 24 VAC |
| Operating voltage | 10 to 60 VDC and 20 to 30 VAC |
| Rated current | ODW-7x0-F2 models: 400 mA @ 12 VDC 200 mA @ 24 VDC 100 mA @ 48 VDC ODW-7x0-F1 models: 300 mA @ 12 VDC 150 mA @ 24 VDC 75 mA @ 48 VDC |
| Rated frequency | DC and 48 to 62 Hz |
| Inrush current I²t | 0.2 A ² s |
| Startup current^a | 1.0 A _{peak} |
| Polarity | Reverse polarity protected |
| Redundant power input | Yes |
| Isolation | ODW-710 models: To PROFIBUS DP and status port ODW-720 models: To RS-232 and status port ODW-730 models: To RS-485 and status port |
| Connector | Detachable screw terminal |
| Connector size | 0.75 - 2.5 mm ² (AWG 18 - 13) Connect the unit using at least 18 AWG (0.75 mm ²) wiring |
| Shielded cable | Not required |

^aExternal supply current capability for proper startup

| Status | |
|---------------------------|---|
| Port type | Signal relay, changeover contacts |
| Rated voltage | Up to 48 VDC |
| Operating voltage | Up to 60 VDC |
| Contact rating | 500 mA at 48 VDC |
| Contact resistance | < 50 mW |
| Isolation | ODW-710: PROFIBUS DP and power port ODW-720: RS-232 and power port ODW-730: RS-485 and power port |
| Connector | Detachable screw terminal |
| Connector size | 0.2 - 2.5 mm ² (AWG 24 - 13) |
| Shielded cable | Not required |



PROTECTIVE FUSE

Branch circuit protection (fuse) is required for this unit with rating not exceeding 20 A. Product should be connected to UL listed power supplies rated 12 - 48 VDC, min 500 mA or 24 VAC, min 500 mA or reliably grounded DC SELV source.

It must be possible to disconnect manually from the power supply. Ensure compliance to national installation regulations.

Replacing the internal fuse must only be performed by Westermo qualified personnel.

| PROFIBUS DP (RS-485)^a | |
|---|---|
| Electrical specification | EIA RS-485/EN 50170 |
| Data rate | 9,600 bit/s, 19.2, 93.75, 187.5, 500 kbit/s, 1.5, 3, 6 and 12 Mbits |
| Data format | 8 data bits, even parity, 1 stop bit, 11 bits total |
| Protocol | PROFIBUS DP/EN 50170 |
| Data rate detection | Yes, compliant with EN 50170 |
| Retiming | Yes |
| Turn around time | In accordance with EN 50170 |
| Transmission range | 1200 m, depending on data rate and cable type (EIA RS-485) |
| Settings | None, external termination and failsafe biasing |
| Protection | Installation Fault Tolerant (up to ±60 V) |
| Isolation | To power and status ports |
| Connector | 9-pin D-sub female |
| Conductive housing | Isolated to all other circuits and housings |
| Shielded cable | Not required |

^aApplicable for ODW-710 models

| RS-232^a | |
|---------------------------------|--|
| Electrical specification | EIA RS-232 |
| Data rate | 300 bit/s - 250 kbit/s |
| Data format | 9 - 12 bits in asynchronous mode Any type in synchronous mode |
| Protocol | Asynchronous or synchronous |
| Data retiming | Asynchronous mode only |
| Transmission range | 15 m |
| Isolation | To power and status ports |
| Connector | 9-pin D-sub female (DCE) |
| Conductive housing | Isolated to all other circuits and housings |
| Shielded cable | Not required, except when installed in railway applications as signalling and telecommunications apparatus and located close to rails ^b . |

^aApplicable for ODW-720 models

^bTo minimise the risk of interference, a shielded cable is recommended when the cable is located inside 3 m boundary to the rails and connected to this port.

The cable shield should be properly connected (360°) to an earthing point within 1 m from this port.

This earthing point should have a low impedance connection to the conductive enclosure of the apparatus cabinet, or similar, where the unit is built-in. This conductive enclosure should be connected to the earthing system of an installation and may be directly connected to the protective earth.

| RS-422/485^a | |
|--|--|
| Electrical specification | EIA RS-485, 2-wire or EIA RS-422 4-wire twisted pair |
| Data rate | 300 bit/s - 1.5 Mbit/s |
| Data format | 9 - 12 bits |
| Protocol | Start-bit followed by 8-11 bits |
| Retiming | Yes |
| Turning time (2-wire RS-485) | One t_{bit} $t_{bit} = 1 / \text{Baud rate}$ (Baud rate in bit/s) |
| Transmission range | < 1200 m, depending on data rate and cable type (EIA RS-485) |
| Settings | 120 Ω termination and failsafe biasing 680 Ω |
| Protection | Installation Fault Tolerant (up to ± 60 V) |
| Isolation | To power and status ports |
| Connector | Detachable screw terminal |
| Connector size | 0.2 - 2.5 mm ² (AWG 24 - 13) |
| Shielded cable | Not required |

^aApplicable for ODW-730 models

5.2. Type Tests and Environmental Conditions

| Environmental phenomena | Basic standard | Description | Test levels |
|------------------------------|----------------|---|---|
| ESD | EN 61000-4-2 | Enclosure | Contact: ± 6 kV Air: ± 8 kV |
| RF field AM modulated | EN 61000-4-3 | Enclosure | 10 V/m 80% AM (1 kHz), 80 to 800 MHz) 20 V/m 80% AM (1 kHz), 800 MHz to 1 GHz) 20 V/m 80% AM (1 kHz), 1.4 to 2.7 GHz) |
| RF field 900 MHz | ENV 50204 | Enclosure | 20 V/m pulse modulated 200 Hz, 900 ± 5 MHz |
| Fast transients | EN 61000-4-4 | Signal ports | ± 2 kV |
| | | Power ports | |
| Surge | EN 61000-4-5 | Signal ports unbalanced | ± 2 kV line to earth, ± 2 kV line to line |
| | | Signal ports balanced | ± 2 kV line to earth, ± 1 kV line to line |
| | | Power ports | ± 2 kV line to earth, ± 2 kV line to line |
| RF conducted | EN 61000-4-6 | Signal ports | 10 V 80% AM (1 kHz), 0.15 to 80 MHz |
| | | Power ports | |
| Pulse magnetic field | EN 61000-4-9 | Enclosure | 300 A/m, 6.4/16 μ s pulse |
| Mains frequency 50 Hz | EN 61000-4-16 | Signal ports | 100 V 50 Hz line to earth |
| | SS 436 15 03 | | 250 V 50 Hz line to line |
| Radiated emission | CISPR 16-2-3 | Enclosure | EN 61000-6-3 |
| | ANSI C63.4 | | FCC part 15 |
| Conducted emission | CISPR 16-2-1 | AC power ports | EN 61000-6-3 |
| | ANSI C63.4 | | FCC part 15 |
| | CISPR 16-2-1 | DC power ports | EN 61000-6-4 |
| Dielectric strength | UL 60950 | Signal port to all other isolated ports | 2 kVrms, 50 Hz, 1 min |
| | | Power port to all other isolated ports | 3 kVrms, 50 Hz, 1 min 2 kVrms, 50 Hz, 1 min (at rated power < 60 V) |

Table 31. EMC and electrical conditions

| Environmental phenomena | Basic standard | Description | Test levels |
|--------------------------------|------------------------------|-----------------------|--|
| Temperatures | EN 60068-2-1 EN 60068-2-2 | Operational | ODW-7x0-F1: -40 to +70°C ODW-7x0-F2: -40 to +60°C |
| | | Storage and transport | ODW-730-F2: -40 to +60°C All others: -40 to +70°C |
| Humidity | EN 60068-2-30 | Operational | 5-95% relative humidity |
| | | Storage and transport | |
| Altitude | | Operational | 2000 m/80 kPa |
| Service life | | Operational | 10 years |
| Vibration | IEC 60068-2-6 | Operational | 7.5 mm, 5 to 8 Hz 2 g, 8 to 500 Hz |
| Shock | IEC 60068-2-27 | Operational | 15 g, 11 ms |
| Enclosure | UL 94 | PC/ABS | Flammability class V-1 |
| Weight | | | 0.26 kg |
| Degree of protection | | | IP21 |
| Cooling | IEC 529 | Enclosure | Convection |

Table 32. Environmental and mechanical conditions

6. Revision Notes

| Revision | Date | Change description |
|-----------------|-------------|---|
| Rev. B | 2024-12 | 4.4.3.1. DIP-Switch Settings, ODW-730 Models; table 29, illustration for DIP switch S2 ODW-730-F1 updated, 4.4.3.2. Start-up Guide ODW-730-F1, Point-to-Point Application; text updated in step 1, 4.4.3.4. Referring Documents, ODW-730-F2; text updated, 4.4.1.1. DIP-Switch Settings, ODW-710 Models; updated text for Figure 14, 4.4.1.3 Configuration ODW-710-F2: Redundant Ring Configuration: Prepare the Fibre Optical Network; step 1 in instruction updated |
| Rev. A | 2023-01 | First revision of this new user guide with all former 6 separate individual user guides for the ODW-700 series merged into one common ODW-700 series user guide. |

