



Merlin 4600 Series

Industrial IEC 61850-3 Cellular Router

Table of Contents

1. General Information	3
1.1. Legal Information	3
1.2. About This Guide	3
1.3. Software Tools	3
1.4. License and Copyright for Included FLOSS	3
2. Safety and Regulations	4
2.1. Warning Levels	4
2.2. Safety Information	5
2.3. Care Recommendations	7
2.4. Product Disposal	7
2.5. Compliance Information	8
2.5.1. Agency Approvals and Standards Compliance	8
2.5.2. Simplified Declaration of Conformity	8
3. Product Description	9
3.1. Product Description	9
3.2. Available Models	9
3.3. Hardware Overview	10
3.4. Connector Information	11
3.4.1. Power Input	11
3.4.2. Digital I/O Interface	12
3.4.3. Serial Ports	12
3.4.4. Console Port	13
3.4.5. Host Port	13
3.4.6. Antennas	14
3.4.7. Reset Button	14
3.4.8. SFP Transceivers	14
3.5. LED Indicators	15
3.6. Ethernet Port and Fibre SFP LED Behaviour	15
3.7. Dimensions	16
4. Installation	17
4.1. Mounting the Router	17
4.2. Cooling	17
4.3. Connecting Cables	17
4.4. Connecting the Antenna	17
4.5. Inserting SIM Cards	18
4.5.1. Inserting SIM 1 Card	18
4.5.2. Inserting SIM 2 Card	18
4.6. Powering Up	18
5. Specifications	19
5.1. Interface Specifications	19
5.2. Type Tests and Environmental Conditions	21
6. Revision Notes	23

1. General Information

1.1. Legal Information

The contents of this document are provided “as is”. Except as required by applicable law, no warranties of any kind are made in relation to the accuracy and reliability or contents of this document, either expressed or implied, including but not limited to the implied warranties of merchantability and fitness for a particular purpose. Westermo reserves the right to revise this document or withdraw it at any time without prior notice.

Under no circumstances shall Westermo be responsible for any loss of data or income or any special, incidental, and consequential or indirect damages howsoever caused.

More information about Westermo can be found at www.westermo.com.

1.2. About This Guide

This guide is intended for installation engineers and users of the Westermo products.

It includes information on safety and regulations, a product description, installation instructions and technical specifications.

1.3. Software Tools

Related software tools are available at <https://www.westermo.com/support/product-support>.

1.4. License and Copyright for Included FLOSS

This product includes software developed by third parties, including Free/Libre Open Source Software (FLOSS). The specific license terms and copyright associated with the software are included in each software package respectively. Please visit the product web page for more information.

Upon request, the applicable source code will be provided. A nominal fee may be charged to cover shipping and media. Please direct any source code request to your normal sales or support channel.

2. Safety and Regulations

2.1. Warning Levels

Warning signs are provided to prevent personal injuries and/or damages to the product. The following levels are used:



Level of warning	Description	Consequence personal injury	Consequence material damage
 WARNING	Indicates a potentially hazardous situation	Possible death or major injury	Major damage to the product
 CAUTION	Indicates a potentially hazardous situation	Minor or moderate injury	Moderate damage to the product
 NOTICE	Provides information in order to avoid misuse of the product, confusion or misunderstanding	No personal injury	Minor damage to the product
 NOTE	Used for highlighting general, but important information	No personal injury	Minor damage to the product

Table 1. Warning levels

2.2. Safety Information

Before installation:

Read this manual completely and gather all information available on the product. Make sure it is fully understood. Check that your application does not exceed the safe operating specifications for the product.

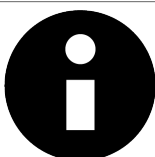

SAFETY DURING INSTALLATION

The product must be installed and operated by qualified service personnel and installed into an apparatus cabinet or similar, where access is restricted to service personnel only.

Before energising and connecting communication cables to the product, ensure a protective earthing conductor is first connected to the protective earthing terminal (only valid for metallic housings). Westermo recommends a cross-sectional area of at least 4 mm².

Upon removal of the product, disconnect the product from the power supply and all other communication ports before disconnecting the protective earthing conductor.



SAFETY USE

This equipment is not suitable for use in locations where children are likely to be present.



HAZARDOUS VOLTAGE

Do not open an energised product. Hazardous voltage may occur when connected to a power supply.



PROTECTIVE FUSE

The power supply wiring must be sufficiently fused.

It must be possible to disconnect manually from the power supply. Ensure compliance to national installation regulations.

This product has no internal fuse and should be connected via an external fuse for protection.



POWER SUPPLY CONNECTION

There are safety regulations governing the power source that can be used in conjunction with the product. Refer to chapter Interface Specifications.



EARTH CONNECTION

For correct function, the earth connection needs to be properly connected to a designated protective earthing rail (only valid for metallic housings). Torque: 3.1 Nm.



INDOOR USE ONLY

The device is to be connected only to networks without routing to the outside plant. All communication ports are for indoor use only.



REDUCE THE RISK OF FIRE

To reduce the risk of fire, use only telecommunication line cords with a cable diameter of AWG 26 or larger. Regarding power cable dimensions, see chapter Interface Specifications.



RADIO PRODUCTS

Observe the usage limitations of radio products at filling stations, in chemical plants, in systems with explosives or potentially explosive locations.

The product may not be used in airplanes. Exercise particular caution near personal medical aids, such as pacemakers and hearing aids. Never perform work on the antenna system during a thunderstorm.

To fulfill human safety, a minimum separation distance of 20 cm or more should be maintained between the antenna of the product and personnel during operation.



CLASS 1 LASER PRODUCT

Do not look directly into a fibre optical port or any connected fibre.



HANDLING OF SFP TRANSCEIVERS

This information applies only to products equipped with SFP fibre ports.

SFP transceivers are supplied with plugs to avoid contamination inside the optical port. They are very sensitive to dust and dirt. If the fibre optic cable is disconnected from the product, a protective plug must be used on the transmitter/receiver. The protective plug must be kept on during transportation. The fibre optic cable must be handled the same way.



ELECTROSTATIC DISCHARGE (ESD)

Prevent electrostatic discharge damage to internal electronic parts by discharging your body to a grounding point (e.g. use a wrist strap).



HOT SURFACE

Be aware that the surface of this product may become hot. When it is operated at high temperatures, the external surface may exceed Touch Temperature Limit according to the product's relevant electrical safety standard.



CABLE TEMPERATURE RATING FOR FIELD TERMINAL WIRES

There may be a requirement on the minimum temperature rating of the cable to be connected to the field wiring terminals, see chapter Interface Specifications.

2.3. Care Recommendations

Follow the care recommendations below to maintain full operation of the product and to fulfill the warranty obligations:

- Do not drop, knock or shake the product. Rough handling above the specification may cause damage to internal circuit boards.
- Use a dry or slightly water-damp cloth to clean the product. Do not use harsh chemicals, cleaning solvents or strong detergents.
- Do not paint the product. Paint can clog the product and prevent proper operation.

If the product is used in a manner not according to specification, the protection provided by the equipment may be impaired.

If the product is not working properly, contact the place of purchase, the nearest Westermo distributor office or Westermo technical support.

2.4. Product Disposal

This symbol means that the product shall not be treated as unsorted municipal waste when disposing of it. It needs to be handed over to an applicable collection point for recycling electrical and electronic equipment.

By ensuring the product is disposed of correctly, you will help to reduce hazardous substances and prevent potential negative consequences to both the environment and human health, which could be caused by inappropriate disposal.



Figure 1. WEEE symbol for treatment of product disposal

2.5. Compliance Information

2.5.1. Agency Approvals and Standards Compliance

Type	Approval/Compliance
EMC	<ul style="list-style-type: none">• EN/IEC 61000-6-2, Immunity industrial environments• EN/IEC 61000-6-3, Emission residential environments• EN/IEC 61000-6-4, Emission industrial environments• EN 50121-4, Railway signalling and telecommunications apparatus• IEC 61850-3, Communication networks and systems for power utility automation – Part 3: General requirements
Safety	<ul style="list-style-type: none">• EN 62368-1, Safety Communication Technology• UL 62368 (pending)
North American standards/approvals	<ul style="list-style-type: none">• UL 62368-1, FCC, PTCRB, AT&T, Verizon, T-Mobile (all pending)

Table 2. Agency approvals and standards compliance

2.5.2. Simplified Declaration of Conformity

Hereby, Westermo declares that this product is in compliance with applicable EU directives and UK legislations. The full declaration of conformity and other detailed information is available at www.westermo.com/support/product-support.



Figure 2. The European Conformity and the UK Conformity Assessment markings

3. Product Description

3.1. Product Description

The Merlin 4600 series of versatile cellular routers provide high speed data network connectivity for demanding industrial, smart grid and trackside applications. Coupled with the Zero Touch deployment software Activator, it provides cost-effective, reliable, and consistent onboarding of routers in large-scale projects.

This compact, rugged unit is suited to tight spaces. It meets the requirements of IEC 61850-3 Class 1 Medium Voltage substation and also railway trackside EN 50121-4. The power supply and Ethernet ports benefit from a high level of galvanic isolation, up to 4 kVrms. Its high MTBF and wide temperature range support maximum service life.

To achieve best-in-class cybersecurity, the Merlin series is equipped with a TPM (Trusted Platform Module) chip that keeps cryptographic keys secure. Secure Boot ensures that the unit boots using only software that is signed and trusted by manufacturer. A set of cybersecurity tools is available as standard including VPN and stateful Firewall support for data security and user authentication.

The built-in industrial protocol gateway enables several devices using different protocols to be accessed via a common protocol interface. The unit supports up to 6 digital inputs and 2 outputs for local control or monitoring. Support for more digital inputs and outputs is possible using external modules.

3.2. Available Models

See datasheet for full list of models available.

3.3. Hardware Overview

The location of interfaces ports and LED indicators for Merlin-4609-F2G-T4-S2-DI6-DO2-LV and subsets thereof is shown here. For Merlin-4609-T6-S2-LV, see details later in this section.

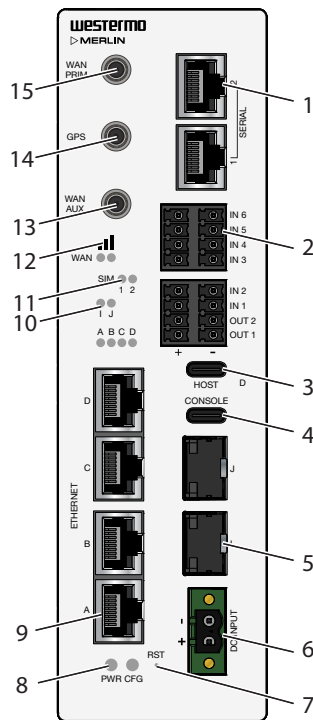

Figure 3. Location of interface ports and LED indicators, illustrated by a Merlin-4609-F2G-T4-S2-DI6-DO2-LV model

No.	Description	No.	Description
1	Serial ports	2	Digital I/Os
3	USB-C Host port	4	USB-C Console port
5	SFP ports	6	Power connection
7	Reset button	8	Power and configuration LEDs
9	Ethernet RJ45 ports	10	Ethernet status LEDs
11	SIM LEDs	12	WAN signal strength
13	WAN auxiliary SMA connector	14	GPS SMA connector
15	WAN primary SMA connector		

The location of interface ports and LED indicators for Merlin-4609-T6-S2-LV is shown here.

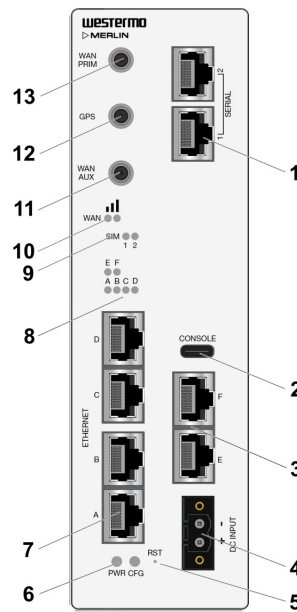

Figure 4. Location of interface ports and LED indicators, illustrated by a Merlin-4609-T6-S2-LV model

No.	Description	No.	Description
1	Serial ports	2	USB-C Console port
3	Ethernet RJ45 ports	4	Power connection
5	Reset button	6	Power and configuration LEDs
7	Ethernet RJ45 ports	8	Ethernet status LEDs
9	SIM LEDs	10	WAN signal strength
11	WAN auxiliary SMA connector	12	GPS SMA connector
13	WAN primary SMA connector		

3.4. Connector Information

3.4.1. Power Input

Illustration	Position	Product marking	Direction	Description
<p>DC INPUT</p>	1	DC+	Input	Supply voltage
	2	DC-	Input	Supply voltage

Table 3. Power input

The positive input is marked with a plus sign, "+". The negative input is marked with a minus sign, "-". Connect the voltage to the + pin and the return to the - pin on the power input.



NOTICE - POWER SUPPLY

Where an AC/DC-adaptor has not been supplied, a power supply of no greater than 100 W should be used, with a current limit of 1 Amp.

The product can be supplied with power from a source that complies with PS2/LPS according to UL/IEC 62368-1 or with LPS according to UL/IEC 60950-1, the latest edition or equivalent. Such a power supply shall not exceed 100W after 5 seconds.

3.4.2. Digital I/O Interface

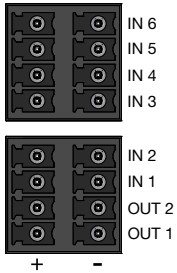

Figure 5. Pinout of the digital I/O sockets

On the first digital I/O socket, there is a 4 x 2 pin connector comprising two inputs and two outputs. The second digital I/O socket has four inputs.

The relay contact output has 220 VDC 2A rating.

The output is connected to a pair of relay contacts that are normally open, that is open when no power is applied.

3.4.3. Serial Ports

A pair of asynchronous serial ports may be present on the router. The serial ports are named as follows, also their identifiers for use within the terminal server configuration:

Label	<code>tservd.port.serialPortName</code>
SERIAL 1	serial1
SERIAL 2	serial2

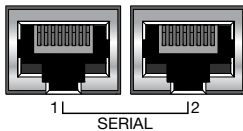

Figure 6. Serial ports

Each serial port is software configurable to operate in either RS-232 or RS-485 mode.

The pin numbering of the serial port connector is shown below.

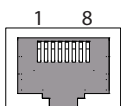

Figure 7. Pin numbering of serial port

RS-232 ports

When you configure a serial port to operate as an RS-232 interface, it supports the following signals:

- Transmit Data
- Receive Data
- CTS
- RTS
- DSR
- DTR

The pin numbering of the RJ45 socket, when viewed from the front of the unit, is as shown below. The RS-232 interface is wired as a DCE.

Illustration	Pin no.	Signal	Direction	Description
	1	DSR	Out	Data Set Ready
	2	DCD	Out	Data Carrier Detect
	3	DTR	In	Data Terminal Ready
	4	SG	-	Signal Ground, not chassis ground
	5	RD	Out	Receive Data
	6	TD	In	Transmit Data
	7	CTS	Out	Clear To Send
	8	RTS	In	Request To Send

Table 4. RS-232 connection

RS-485 ports

When you configure a serial port to operate as an RS-485 interface, it supports both two-wire (half-duplex) and four-wire (full-duplex) modes. Configuration between two-wire and four-wire RS-485 modes is under software control. The pin-numbering of the RJ45 connector in RS-485 mode, when viewed from the front of the unit, is shown below.

Illustration	Pin no.	Signal		Direction	Description
		Four-wire mode	Two-wire mode		
	1				
	2	R-	-	In	Four-wire: Receive
	3	T-	T-/R-	Out/In	Four-wire: Transmit Two-wire: Transmit/Receive
	4				
	5	R+		In	Four-wire: Receive
	6	T+	T+/R+	Out/In	Four-wire: Transmit Two-wire: Transmit/Receive
	7				
	8				

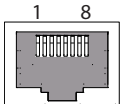
Table 5. RS-485 port pinout

3.4.4. Console Port

The router has a USB console port with a type C connector. The router acts as a device.

3.4.5. Host Port

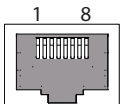
The router has a single USB type C host port. The router presents as a host. Power is supplied by the router at 5V and up to 1A.

3.4.6. Antennas

The router has three SMA connectors. They are:

- Two LTE antennas for the mobile radio - a MAIN and an AUXiliary
- Single antenna for GNSS/GPS

3.4.7. Reset Button

Use the reset button to request a system reset. When pressing the reset button, all LEDs turn on simultaneously. The length of time holding the reset button will determine its behaviour.

Press duration	PWR/CONFIG LED behaviour	Router behaviour on depress
0-3 seconds	Solid on	Normal reset to running config. No special LED activity.
3-15 seconds	Flashing fast	Releasing 3-15 seconds switches the router back to factory configuration. Note: this will wipe the configurations, both config1 and config2.
15-20 seconds	Solid on	Releasing 15-20 seconds performs a normal reset to running config.
20-30 seconds	Flashing slowly	Releasing 20-30 seconds reboots the router to recovery mode. Only to be done in case of emergency and under the guidance of Westermo support staff. Note: this may wipe the configurations, both config1 and config2.
> 30 seconds	Solid on	Releasing after 30 seconds performs a normal reset.

Table 6. Merlin series router reset behaviour

Recovery Mode

Recovery mode is a fail-safe mode where the router can load a default configuration from the router's firmware. If the router goes into recovery mode, all config files are kept intact. After the next reboot, the router will revert to the previous config file.

Use recovery mode to manipulate the config files, but it should only be used if all other config files are corrupt. If the router has entered recovery mode, contact your local reseller for access information.

3.4.8. SFP Transceivers

Each SFP slot can hold one SFP transceiver. See "Transceiver User Guide 6100-0000" for transceiver handling instructions, which also can be downloaded from the product support pages at www.westermo.com/support/product-support.

In the event of contamination, the optical connectors in the SFP transceivers should only be cleaned by the use of forced nitrogen and some kind of cleaning stick. Recommended cleaning fluids are methyl-, ethyl-, isopropyl- or isobutyl alcohol, hexane or naphtha.



HANDLING OF SFP TRANSCEIVERS

This information applies only to products equipped with SFP fibre ports.

SFP transceivers are supplied with plugs to avoid contamination inside the optical port. They are very sensitive to dust and dirt. If the fibre optic cable is disconnected from the product, a protective plug must be used on the transmitter/receiver. The protective plug must be kept on during transportation. The fibre optic cable must be handled the same way.

3.5. LED Indicators

The LED indicators described in this section are all single colour LEDs. When the router is powered on, the power LED is green.

The possible LED states are:

- Off
- Flashing slowly
- Flashing quickly
- On

LED	Status	Description
Booting up		The router takes less than a minute to boot up. During this time, the power LED flashes. Other LEDs display different diagnostic patterns during boot up. Booting is complete when the power LED stops flashing and stays on steady.
Power	On	Power is present
	Off	No power. Boot loader does not exist.
	Flashing	Booting
Config	On	The router is running a valid configuration file.
	Flashing slowly	The router is running in recovery mode (2.5 flashes/second)
	Flashing quickly	The router is running in factory configuration (5 flashes/second)
SIM	On	SIM selected and registered on the 3G/4G network
	Off	Not selected or SIM not inserted
	Flashing	SIM selected and not registered on the network
3G/LTE cellular signal strength LED	Both LEDs off	Data link not connected or signal strength ≤ -113 dBm
	Left LED on	Data link connected and signal strength ≤ -89 dBm
	Right LED off	
	Left LED off	Data link connected and signal strength is between -89 to -69 dBm
	Right LED on	
Both LEDs on	Data link connected and signal strength > -69 dBm	

Table 7. LED indicators

3.6. Ethernet Port and Fibre SFP LED Behaviour

Each Ethernet port and each fibre SFP port has a single green-coloured LED.

LINK LED (green)	On	Physical Ethernet link detected.
	Off	No physical Ethernet link detected.
	Flashing	Data is being transmitted or received over the link.

Table 8. Ethernet and fibre LED behaviour and descriptions

3.7. Dimensions

Dimensions are stated in mm and are regardless of model.

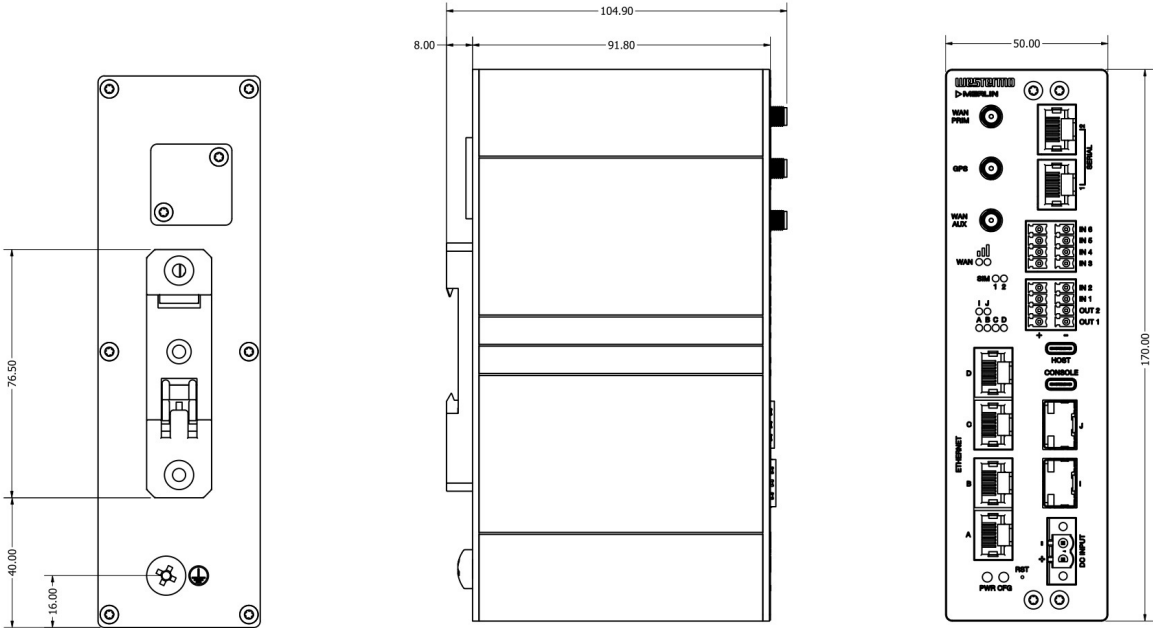

Figure 8. Dimensional drawing

4. Installation

4.1. Mounting the Router

The router is fitted with a DIN-rail clip by default. To attach the router to a DIN-rail:

1. Position the router so that the spring of the DIN-clip rests on the DIN-rail.
2. Push the router in an upward direction so that the spring of the DIN-clip compresses and the top hook of the DIN-clip slides and clamps to the DIN-rail.

To remove the router from the DIN-rail, simply reverse the procedure.

4.2. Cooling

This product uses convection cooling. Spacing is recommended for the use of the product in full operating temperature range and service life. To avoid obstructing the airflow around the product, use the following spacing rules.

Minimum spacing of 25 mm (1 inch) above/below and 10 mm (0.4 inches) left/right of the product is recommended.



REDUCE THE RISK OF FIRE

To reduce the risk of fire, use only telecommunication line cords with a cable diameter of AWG 26 or larger. Regarding power cable dimensions, see chapter Interface Specifications.

4.3. Connecting Cables

Connect one end of the Ethernet cable into port A and the other end to your PC or switch.

4.4. Connecting the Antenna

If only connecting one LTE antenna, screw the antenna into the MAIN SMA connector. If you are using more than one LTE antenna, screw the main antenna into the MAIN SMA connector and the secondary antenna into the WAN-AUX SMA connector.

Be careful to select an antenna that ensures the equipment complies with local regulatory requirements.

In North America, Westermo has indicated to PTCRB the following set of antennas for use with this equipment:

Article Number	Model
160-00148	2J 2J7724Ma - Cellular/LTE MIMO Magnetic Mount with two 3m LL100 leads, SMA Male
160-00184	2J 2J2183K-B07H-300LL195-C91GST - Cellular/LTE wall mount antenna with a 3m LL195 lead, SMA Male

Table 9. List of antennas for use with this equipment in North America, as indicated to PTCRB

To comply with the requirements of PTCRB in North America:

1. It is recommended to select an antenna from the list above.
2. Should a user select their own antenna, Westermo strongly recommends that it be mounted with at least 20cm of cable.
3. Where a user selects a directly mounted antenna, it must comply with the OTA requirements of the PTCRB.

4.5. Inserting SIM Cards

On the rear side of the router there are two SIM slots. To access the SIM cards, first remove the SIM cover using a suitable screwdriver (not supplied). Only the proper driver can drive a specific head size without risk of damaging the driver or screw.

The product datasheet indicates the correct size of SIM card to use. A Mini-SIM card (2FF) is of size 25mm x 15mm x 0.76mm. Do not use a card larger than or smaller than that specified in the product datasheet or you may cause damage to the unit. Using the correct SIM card size helps avoid issues such as incompatibility or improper insertion that can lead to device malfunction.

4.5.1. Inserting SIM 1 Card

Ensure the router is powered off.

- Remove the SIM cover using a suitable screwdriver.
- Hold the SIM 1 card with the chip side facing down and the cut corner facing away from you, to the left.
- Gently push the SIM card into the upper SIM slot 1 until it clicks in.
- Screw the SIM cover back on with the screwdriver.

4.5.2. Inserting SIM 2 Card

- If you are using a second SIM, hold the SIM 2 card with the chip side facing up and the cut corner front right facing away from you.
- Gently push the SIM card into the lower SIM slot 2 until it clicks in.
- Screw the SIM cover back on with the screwdriver.

4.6. Powering Up

Plug the power cable first into the device and then to a suitable power source. The router takes less than a minute to boot up. During this time, the power LED flashes.

Other LEDs display different diagnostic patterns during boot up. Booting is complete when the power LED stops flashing and stays on steady.

5. Specifications

5.1. Interface Specifications

DC, Power port	
Rated voltage	12 to 48 VDC
Operating voltage	9.6 to 60 VDC
Rated current	580 mA at 12 VDC 170 mA at 48 VDC
Rated frequency	DC
Inrush current	$2.74 \times 10^{-3} \text{ A}^2\text{s}$ at 12 VDC
Polarity	Reverse polarity protected
Redundant power input	No
Isolation	All other ports
Connector	Push-in spring connectors
Conductor cross section	0.2-2.5 mm ² (AWG 24-12)
Stripping length cable	7 mm
Tightening torque, screw flange	0.3 Nm
Shielded cable	Not required

Ethernet TX	
Electrical specification	IEEE std 802.3
Data rate	10 Mbit/s, 100 Mbit/s, manual or auto
Duplex	Full or half, manual or auto
Transmission range	Up to 150 m with CAT5e cable or better
Isolation	All other ports
Connection	RJ-45, auto MDI/MDI-X
Cabling	Shielded CAT5e or better is recommended
Number of ports	4

RS-232/485	
Electrical specification	Configurable for EIA RS-232 or EIA RS-422/485
Data rate	RS-232: 50 bit/s - 1 Mbit/s RS-485: 50 bit/s - 20 Mbit/s
Data format	7 or 8 data bits, odd, even or none parity, 1 or 2 stop bits (2 stop bits only when no parity is set)
Transmission range	RS-232: 15 m/49 ft RS-485: Up to 1200 m/0.74 mi, depending on data rate and cable type
Isolation	To all other ports
Connection	RS-232: RJ-45 according to EIA-561 RS-485: RJ-45
Shielded cable	Recommended
Number of ports	2

Ethernet SFP pluggable connections (FX or TX)	
Electrical specification	IEEE std 802.3
Data rate	1000 Mbit/s transceivers supported
Duplex	Full or Auto, depends on transceiver
Transmission range	Depends on transceiver
Connection	SFP slot holding fibre transceiver or copper transceiver
Number of ports	2

I/O connection, Relay output	
Maximum voltage/current	220 VDC/2A
Connect resistance	<100mΩ
Isolation	To all other ports
Connector	Detachable latch terminal
Conductor cross section	0.14 - 1.5 mm ² (AWG 28 - 16)
Stripping length cable	7 mm
Number of ports	2

I/O connection, Digital input	
Maximum voltage/current	24 VDC
Voltage levels	Logic one: >9.9 VDC Logic zero: <7.4 VDC
Isolation	To all other ports
Connector	Detachable latch terminal
Conductor cross section	0.14 - 1.5 mm ² (AWG 28 - 16)
Stripping length cable	7 mm
Number of inputs	6

USB Host	
Electrical specification	USB 2.0 host interface
Data rate	Up to 12 Mbit/s (full speed mode)
Circuit type	SELV
Maximum supply current	500 mA
Connection	USB receptacle connector type C

Console port	
Electrical specification	USB 2.0 host interface
Data rate	115.2 kbit/s
Circuit type	SELV
Data format	8 data bits, no parity, 1 stop bit, no flow control
Connection	USB receptacle connector type C

5.2. Type Tests and Environmental Conditions

Environmental phenomena	Basic standard	Description	Test levels
ESD	EN 61000-4-2	Enclosure	Contact: ± 6 kV Air: ± 8 kV
Fast transients	EN 61000-4-4	Power port	± 4 kV, direct coupling
		Ethernet ports	± 4 kV, capacitive coupling clamp
		Earth	
		Serial ports	
		I/O port	
Surge	EN 61000-4-5	Power port	L-E: ± 2 kV, 12Ω , $9 \mu\text{F}$, $1.2/50 \mu\text{s}$ L-E: ± 2 kV, 42Ω , $0.5 \mu\text{F}$, $1.2/50 \mu\text{s}$ L-L: ± 1 kV, 2Ω , $18 \mu\text{F}$, $1.2/50 \mu\text{s}$ L-L: ± 1 kV, 42Ω , $0.5 \mu\text{F}$, $1.2/50 \mu\text{s}$
		Ethernet ports	L-E: ± 2 kV, 2Ω , direct on shield, $1.2/50 \mu\text{s}$
		I/O port	L-E, L-L: ± 1 kV, 12Ω , $9 \mu\text{F}$, $1.2/50 \mu\text{s}$ L-E, L-L: ± 2 kV, 42Ω , $0.5 \mu\text{F}$, $1.2/50 \mu\text{s}$
		RS-232	L-E: ± 2 kV, 2Ω , $0.5 \mu\text{F}$
		RS-422/485	L-E: ± 2 kV, 42Ω , $0.5 \mu\text{F}$
Power frequency magnetic field	EN 61000-4-8	Enclosure	100 A/m; 50 Hz
Pulsed magnetic field	EN 61000-4-9	Enclosure	1000 A/m; 50 Hz
Radiated RF immunity	EN 61000-4-3	Enclosure	20 V/m at (80 - 3800) MHz 5 V/m at (2.7 - 6) GHz 1 kHz sine, 80% AM
Conducted RF immunity	EN 61000-4-6	Power port	10 V, 80% AM, 1 kHz; (0.15-80) MHz
		Ethernet	
		I/O port	
		Serial ports	
		Earth	
Radiated RF emission	EN 55032, EN 61000-6-4	Enclosure	Class B (Residential), 30 MHz to 6 GHz
Conducted RF emission	EN 55032, EN61000-6-4	Power port	Class B
		Ethernet	Class B
Dielectric strength	UL 62368-1	Power port to all other ports	4 kVrms, 50 Hz, 1 min
	UL 62368-1	I/O port to all other ports	1.5 kVrms, 50 Hz, 1 min
		RS-232 port to all other ports	
		RS-422/485 port to all other ports	
	UL 62368-1IEEE 802.3	Ethernet TX to all other ports	4 kVrms, 50 Hz, 1 min
UL 62368-1IEEE 802.3	Ethernet SFP to all other ports	1.5 kVrms, 50 Hz, 1 min	

Table 10. EMC and electrical conditions

Environmental phenomena	Basic standard	Description	Test levels
Temperatures	EN 60068-2-1 EN 60068-2-2	Operational	-40 to +70°C (-40 to +158°F) ^a
Humidity	EN 60068-2-30	Operational	5-95% relative humidity
MTBF	Telcordia	Ground benign, 25°C	825,000 hours
Enclosure	EN 62368-1	Aluminium	Fire enclosure
Weight			0.7 kg
Cooling			Convection

^aRefer to "Safety Information" chapter regarding touch temperature

Table 11. Environmental and mechanical conditions

6. Revision Notes

Revision	Date	Change description
Rev. A	2021-06-21	First version
Rev. B	2021-09-28	Revised drawings and metrics
Rev. C	2021-10-04	Revised model table
Rev. D	2024-05-28	Extra warnings
Rev. E	2024-06-28	SIM card size warning

WESTERMO

Westermo • Metallverksgatan 6, SE-721 30 Västerås, Sweden

Tel +46 16 42 80 00 Fax +46 16 42 80 01

E-mail: info@westermo.com

www.westermo.com