

Security Baseline Report

Project Test Project
Generated 2021-03-23 10:09
Errors No errors detected during report generation

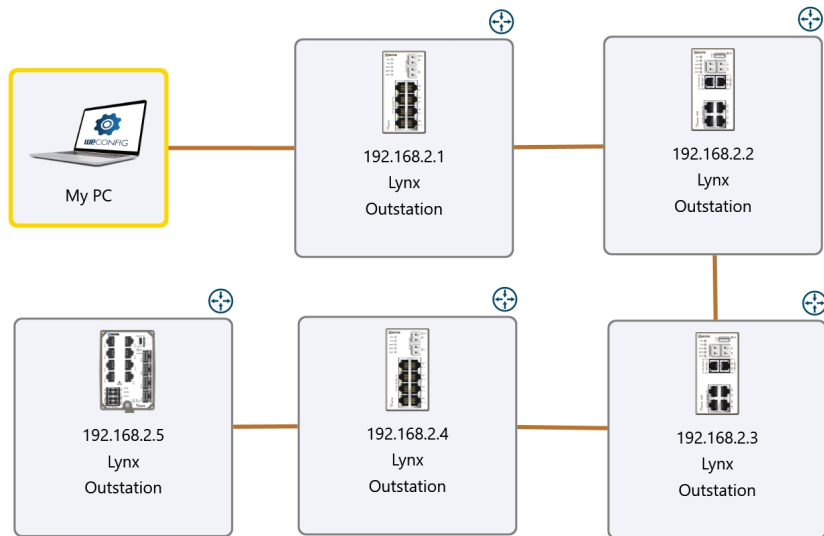

Possible Vulnerabilities

Lynx@Outstation

Hostname Lynx
Location Outstation
Serial Number 14224
Firmware Lynx
Model L208-F2G-S2
MAC 00:07:7C:0D:89:60
Firmware 4.29.0
Default Password Yes

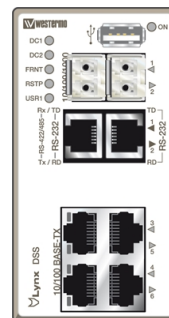

Ports that are Enabled but Unused

1 2 4 6

Lynx@Outstation

Hostname Lynx
Location Outstation
Serial Number 14211
Firmware Lynx
Model L210-F2G
MAC 00:07:7C:0D:87:C0
Firmware 4.29.0
Default Password Yes

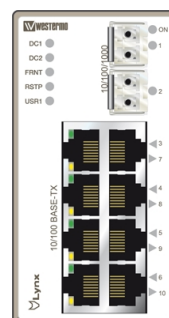

Ports that are Enabled but Unused

1 2 4 5 6 8 9 10

Lynx@Outstation

Hostname Lynx
Location Outstation
Serial Number 21776
Firmware Lynx
Model L208-F2G-S2
MAC 00:07:7C:16:E6:E0
Firmware 4.29.0
Default Password Yes

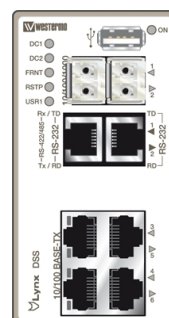

Ports that are Enabled but Unused

1 2 4 6

Lynx@Outstation

Hostname Lynx
Location Outstation
Serial Number 18857
Firmware Lynx
Model L210-F2G
MAC 00:07:7C:13:19:40
Firmware 4.29.0
Default Password Yes

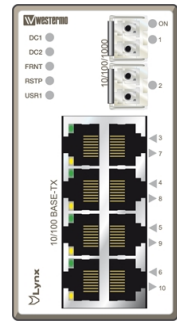

Ports that are Enabled but Unused

1	2	4	5	7	8
9	10				

Lynx@Outstation

Hostname Lynx
Location Outstation
Serial Number 1020
Firmware Lynx
Model Lynx-5512-E-F4G-T8G-LV
MAC 00:07:7C:1C:D0:80
Firmware 5.9.2
Default Password Yes

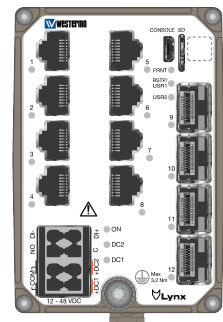

Ports that are Enabled but Unused

eth1	eth2	eth3	eth4	eth6	eth7
eth8	eth9	eth10	eth11	eth12	

Full Report

Lynx@Outstation

Hostname Lynx
Location Outstation
Serial Number 14224
Family Lynx
Model L208-F2G-S2
MAC 00:07:7C:0D:89:60
Firmware 4.29.0
Config Baseline <none>
Default Password Yes

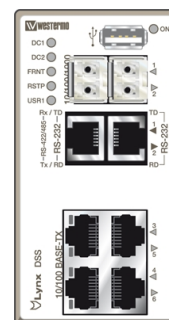

Ports

1	Enabled	2	Enabled	3	Enabled
VLANs	U: 1	VLANs	U: 1	VLANs	U: 1
4	Enabled	5	Enabled	6	Enabled
VLANs	U: 1	VLANs	U: 1	VLANs	U: 1

VLAN

VID 1
Interface Address 192.168.2.3/24
Services http, https, ipconfig, snmp, ssh
Tagged Ports <none>
Untagged Ports 1, 2, 3, 4, 5, 6
MAC Filter <none>
802.1X <none>
Port Access Excl. <none>

Installed Certificates

Label web-default
Subject OU=TEMPORARY, CN=REPLACE
Valid from 01/01/1970 00:03:13
Valid to 19/06/2045 01:03:13

SNMP v2

Read Comm. public
Write Comm. <not set>
Trap Comm. trap
Trap Hosts <none>

SNMP v3 Users

AAA

Login Method <none>

Firewall

Security Baseline
Report

Firewall not activated.

Lynx@Outstation

Hostname Lynx
Location Outstation
Serial Number 14211
Family Lynx
Model L210-F2G
MAC 00:07:7C:0D:87:C0
Firmware 4.29.0
Config Baseline <none>
Default Password Yes

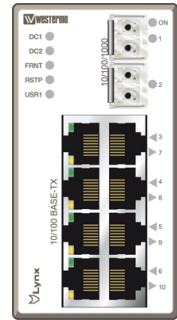

Ports

1	Enabled	2	Enabled	3	Enabled
VLANs	U: 1	VLANs	U: 1	VLANs	U: 1
4	Enabled	5	Enabled	6	Enabled
VLANs	U: 1	VLANs	U: 1	VLANs	U: 1
7	Enabled	8	Enabled	9	Enabled
VLANs	U: 1	VLANs	U: 1	VLANs	U: 1
10	Enabled				
VLANs	U: 1				

VLAN

VID 1
Interface Address 192.168.2.4/24
Services http, https, ipconfig, snmp, ssh
Tagged Ports <none>
Untagged Ports 1, 2, 3, 4, 5, 6, 7, 8, 9, 10
MAC Filter <none>
802.1X <none>
Port Access Excl. <none>

Installed Certificates

Label web-default
Subject OU=TEMPORARY, CN=REPLACE
Valid from 01/01/1970 00:01:05
Valid to 19/06/2045 01:01:05

SNMP v2

Read Comm. public
Write Comm. <not set>
Trap Comm. trap
Trap Hosts <none>

SNMP v3 Users

AAA

Login Method <none>

Firewall

Firewall not activated.

Lynx@Outstation

Hostname Lynx
Location Outstation
Serial Number 21776
Family Lynx
Model L208-F2G-S2
MAC 00:07:7C:16:E6:E0
Firmware 4.29.0
Config Baseline <none>
Default Password Yes

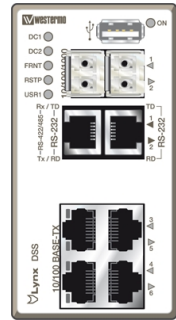

Ports

Port	Status	VLANs	Port	Status	VLANs
1	Enabled	U: 1	2	Enabled	U: 1
4	Enabled	U: 1	5	Enabled	U: 1
3	Enabled	U: 1	6	Enabled	U: 1

VLAN

VID 1
Interface Address 192.168.2.2/24
Services http, https, ipconfig, snmp, ssh
Tagged Ports <none>
Untagged Ports 1, 2, 3, 4, 5, 6
MAC Filter <none>
802.1X <none>
Port Access Excl. <none>

Installed Certificates

Label web-default
Subject OU=TEMPORARY, CN=REPLACE
Valid from 01/01/1970 00:03:25
Valid to 19/06/2045 01:03:25

SNMP v2

Read Comm. public
Write Comm. <not set>
Trap Comm. trap
Trap Hosts <none>

SNMP v3 Users

AAA

Login Method <none>

Firewall

Firewall not activated.

Lynx@Outstation

Hostname Lynx
Location Outstation
Serial Number 18857
Family Lynx
Model L210-F2G
MAC 00:07:7C:13:19:40
Firmware 4.29.0
Config Baseline <none>
Default Password Yes

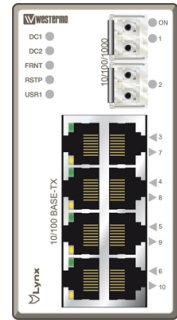

Ports

1	Enabled	2	Enabled	3	Enabled
VLANs	U: 1	VLANs	U: 1	VLANs	U: 1
4	Enabled	5	Enabled	6	Enabled
VLANs	U: 1	VLANs	U: 1	VLANs	U: 1
7	Enabled	8	Enabled	9	Enabled
VLANs	U: 1	VLANs	U: 1	VLANs	U: 1
10	Enabled				
VLANs	U: 1				

VLAN

VID 1
Interface Address 192.168.2.1/24
Services http, https, ipconfig, snmp, ssh
Tagged Ports <none>
Untagged Ports 1, 2, 3, 4, 5, 6, 7, 8, 9, 10
MAC Filter <none>
802.1X <none>
Port Access Excl. <none>

Installed Certificates

Label web-default
Subject OU=TEMPORARY, CN=REPLACE
Valid from 13/01/1970 23:18:33
Valid to 17/02/2046 23:18:33

SNMP v2

Read Comm. public
Write Comm. <not set>
Trap Comm. trap
Trap Hosts <none>

SNMP v3 Users

AAA

Login Method <none>

Firewall

Firewall not activated.

Lynx@Outstation

Hostname Lynx
Location Outstation
Serial Number 1020
Family Lynx
Model Lynx-5512-E-F4G-T8G-LV
MAC 00:07:7C:1C:D0:80
Firmware 5.9.2
Config Baseline <none>
Default Password Yes

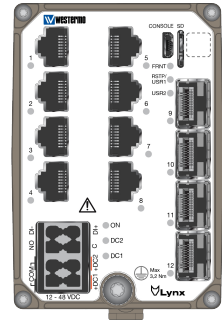

Ports

eth1	Enabled	eth2	Enabled	eth3	Enabled
VLANs	U: 1	VLANs	U: 1	VLANs	U: 1
eth4	Enabled	eth5	Enabled	eth6	Enabled
VLANs	U: 1	VLANs	U: 1	VLANs	U: 1
eth7	Enabled	eth8	Enabled	eth9	Enabled
VLANs	U: 10	VLANs	U: 1	VLANs	U: 1
eth10	Enabled	eth11	Enabled	eth12	Enabled
VLANs	T: 1, 10	VLANs	T: 1, 10	VLANs	T: 1, 10

VLAN

VID	1
Interface Address	192.168.2.5/24
Services	http, https, snmp, ssh
Tagged Ports	eth10, eth11, eth12
Untagged Ports	eth1, eth2, eth3, eth4, eth5, eth6, eth8, eth9
MAC Filter	<none>
802.1X	<none>
Port Access Excl.	<none>
VID	10
Interface Address	<none>
Services	
Tagged Ports	eth10, eth11, eth12
Untagged Ports	eth7
MAC Filter	<none>
802.1X	<none>
Port Access Excl.	<none>

Installed Certificates

Label ddc1fc3
Subject CN=lynx-1c-d0-80.local
Valid from 01/01/1970 00:00:00
Valid to 19/01/2038 03:14:07

SNMP v2

Read Comm. public

Write Comm. <not set>
Trap Comm. trap
Trap Hosts <none>

SNMP v3 Users

AAA

Login Method <none>

Firewall

Not supported.